



# NEW MEXICO

# WATER SYSTEMS OPERATOR CERTIFICATION STUDY MANUAL

*Version IV, January 2011*



**New Mexico Environment Department  
Utility Operator Certification Program  
NMED Surface Water Quality Bureau  
PO Box 5469  
Santa Fe, NM 87502**



NEW MEXICO  
WATER SYSTEMS OPERATOR  
CERTIFICATION STUDY MANUAL

*Version IV*  
*January 2011*

New Mexico Environment Department  
Utility Operator Certification Program

NMED Surface Water Quality Bureau  
PO Box 5469  
Santa Fe, NM 87502

# INTRODUCTION

---

The “NEW MEXICIO WATER SYSTEMS OPERATOR CERTIFICATION STUDY GUIDE” was developed by Fred Ragsdale of Ragsdale and Associates under contract with NMED Surface Water Quality Bureau. With this edition the title has changed to The “NEW MEXICIO WATER SYSTEMS OPERATOR CERTIFICATION STUDY MANUAL” to reflect the addition of further study material. It should be used as a tool to assist Water Systems operators in New Mexico in preparation for taking the New Mexico Distribution Systems Operator, Small Water Systems Operator, and Water Systems Operator certification exams. In New Mexico Water Certification is divided into the following areas:

- § Four classes of Water System Operator certification
- § Three classes of Distribution Systems Operator certification
- § Two classes of Small Water Systems Operator certification

This manual is not intended to be a complete reference manual for technical information. Its purpose is to guide the reader to study material for each of the major subject areas for each of the classes. There is no implied claim that this study guide covers every possible point on which an operator may be tested. However, it is intended to be comprehensive in its coverage of the essential information for each exam. As new technologies are developed and become available in the State of New Mexico further additions will be made to the Study Manual to assist operators in understanding those advanced water treatment technologies.

The manual is divided into fourteen basic chapters. In the future a chapter fifteen will be added containing information on emerging advanced water treatment technologies. The manual also contains a useful Appendix: EPA manual “Response Protocol Toolbox: Planning for and Responding to Drinking Water Contamination Threats and Incidents”. Each chapter in the study manual has basic and advanced study questions and sample test questions that are intended help the individual determine the type of information that is covered in an exam. Basic questions will generally cover information in the Small Water Systems exams and the Class 1 and 2 for Water Systems and Distribution Systems exams. Advanced questions will cover information in the Water Systems Class 3 and 4 and Distribution Systems Class 3 exams. The study questions and sample test questions are designed to direct the reader to exam information that is related

to the chapter topics. There is only one correct answer for the Sample Test Questions. No answer sheet is provided. You will have to look them up.

- ❖ Distribution Systems exams will include information from Chapters 1-5, 7-10, and 13-14.
- ❖ Small Water Systems exam will include information from Chapters 1-5, 7-11, and 13.
- ❖ Advanced Small Water Systems exam **will also** include information from Chapters 6 and 12.
- ❖ Water Systems Class 1 exam will include information from Chapters 1-4, 7-11, and 13-14.
- ❖ Water System Class 2 exam will include information from Chapters 1-11 and 13-14.
- ❖ Water Systems Class 3 and 4 exams will include information from chapters one through fourteen.

The certification exams use several texts as reference manuals for exam topics. Each chapter of the study manual contains references to specific chapters of these manuals for those who wish to access more information on the topics covered in that particular section.

- Office of Water Programs, California State University, Sacramento, *Water Treatment Plant Operation*. 4<sup>th</sup> ed., 1999, Volumes 1 & 2.
- Office of Water Programs, California State University, Sacramento, *Small Water Systems O&M*. 4<sup>th</sup> ed., 2001.
- Office of Water Programs, California State University, Sacramento, *Water Distribution System O&M*. 4<sup>th</sup> ed., 2000.
- ACR Publications, Inc., Skeet Arasmith, *Introduction to Small Water Systems*, 1993.
- Fletcher Driscoll/US Filter, *Groundwater and Wells*, 2<sup>nd</sup> Edition, 1986.

*Special thanks to:*  
*NMED SWQB Utility Operator Certification Program for funding; Bob Padilla for his graphics; the New Mexico Utility Operator Certification Advisory Board for chapter reviews; everyone who helped to proof read the first draft for typos; Bill Peifer for help formatting the original text; Marilyn Still for further typo revisions; and Robert & Nancy Gott of Gott Consulting Services for structuring supplemental text and reformatting the study guide.*

# NEW MEXICO ENVIRONMENT DEPARTMENT SURFACE WATER QUALITY BUREAU UTILITY OPERATOR CERTIFICATION PROGRAM

---

The New Mexico Water Quality Control Commission, through the New Mexico Environment Department (NMED), grants certification for competency to the operators of water and wastewater systems. The Utility Operator Certification Program (UOCP) conducts the testing for certification. Certain requirements must be met before an operator is eligible to take a certification examination.

An operator begins the process by completing a test application from the Utility Operator Certification Program. Applications will only be accepted if they are submitted at least 30 days prior to the exam date. A certification officer will review each application to determine if the operator is eligible to take the requested examination. An application must be submitted every time a test is taken. Examinations are given several times a year at various locations around the state. **Fees** range from **\$25.00 - \$30.00** depending on the examination. A check or money order for the proper amount **must** accompany each exam application and paid to **Utility Operator Certification Program**.

Certificates must be renewed every three years. The renewal date will be the last day of the certificate holder's birthmonth following the third anniversary of the certificate. The UOCP also handles renewal of certificates. Renewal **fees** ranges from **\$20.00 - \$30.00** depending on the level of certification to be renewed per certificate.

The Utility Operator Certification Program maintains training credits for certified operators only. Each operator must keep a record of all training credits earned. Anyone who intends to apply for NM certification must include documentation of training credits when the application is submitted. Certified operators that are taking higher level exams may also have to submit training credit documentation to update training record files at the Utility Operator Certification Program.



All correspondence, including applications, should be mailed to:

**NMED Surface Water Quality Bureau  
Utility Operator Certification Program  
PO Box 5469  
Santa Fe, NM 87502**

Please feel free to call the Utility Operator Certification Program to request information on exam application forms, exam dates and locations, or certification and renewal. The telephone number for the office is **505-827-2804**.

# IMPORTANT FACTS ABOUT OPERATOR CERTIFICATION

An operator, as defined by NM Water Quality Control Commission Regulations, is “any person employed by the owner as the person responsible for the operation of all or any portion of a water supply system or wastewater facility. Not included in this definition are such persons as directors of public works, city engineers, city managers, or other officials or persons whose duties do not include actual operation or direct supervision of water supply systems or wastewater facilities.”

Under the Utility Operator Certification Act, “a certified operator is a person who is certified by the commission as being qualified to supervise or operate one of the classifications of water supply systems or wastewater facilities”. Experience is “actual work experience, full or part-time, in the fields of public water supply or public wastewater treatment. Work experience in a related field may be accepted at the discretion of the commission”. Any claim of related experience will be reviewed by the Water Quality control Commission (WQCC) or its advisory body, the Utility Operators Certification Advisory Board.

The Utility Operator Certification Advisory Board (UOCAB) is a seven-member board appointed to function with the WQCC to establish qualifications of operators, classify systems, adopt regulations, and advise the administration of the Utility Operators Certification Act. Its members are drawn from certified water systems operators and wastewater facility operators in the throughout the State of New Mexico.

Experience that includes operation, maintenance, or repair of water treatment and water distribution systems is accepted based on whether it is full or part-time. The NM Utility Operator Certification Advisory Board will review and approve experience in other related fields, such as commercial plumbing or utility construction. Credit for part-time experience will be based on the percentage of time devoted to actual operation or maintenance. Full time water or wastewater laboratory experience may be counted as operator experience at a rate of 25% of actual experience. The credit for this experience will be determined by review of the UOCAB.

## BASIC CERTIFICATION REQUIREMENTS

There are three basic requirements an operator must meet to qualify for New Mexico certification. All certified operators must have at least **one year** of actual experience in operation or maintenance of a public water system. All levels of certification require **high school graduation or GED** (see substitutions). All levels of certification require a certain number of **training credits** in water systems O&M or related fields.

	EXPERIENCE	TRAINING CREDITS	EDUCATION
<b>Class 1</b>	1 year*	10	HS Grad or GED*
<b>Small Systems</b>	1 year*	10	HS Grad or GED*
<b>Class 2</b>	2 years*	30	HS Grad or GED*
<b>Class 3</b>	4 years*	50	HS Grad or GED*
<b>Class 4</b>	1 year as Class 3	80	HS Grad or GED

\*See Substitutions

## SUBSTITUTIONS

One year of additional experience may be substituted for the high school graduation or GED requirement for all classes **except** Class 4. Education may be substituted for experience or training credits in some cases. The education must be in a water or wastewater related field. One year of vocational education can be substituted for up to one year of experience. Associate and Bachelor degrees in a related field may be substituted for up to three years of experience and 50 training credit hours, depending on the amount of actual experience. The criteria for substitution of education for experience are as follows:

- ❖ No more than one year (30 semester hours) of successfully completed college education in a **non-related field** may be substituted for an additional **six months** of the required experience.
- ❖ **One year** of approved vocational school in the water and/or wastewater field may be substituted for only **one additional year** of the required experience.

- ❖ An **Associate degree** in a two-year program at an approved school in the water and/or wastewater field, and **six months** of actual experience in that field (which may be accrued before, during, or after the school program) may be substituted for the requirements of any level up to and including **Class 2**.
- ❖ An **Associate degree** in a two-year program at an approved school in the water and/or wastewater field and **twelve months** of actual experience in that field (which may be accrued before, during, or after the school program) may be substituted for the requirements of any level up to and including **Class 3**.
- ❖ Completion of at least **three years** of actual experience in the water and/or wastewater field, plus **high school graduation** or equivalent, plus **15 semester hours** of successfully completed college education directly related to the water or wastewater field may be substituted for any level up to and including **Class 3**.
- ❖ A **Bachelor Degree** in a major directly related to the water or wastewater field, plus **two years** of actual experience in that field may be substituted for any level up to and including **Class 3**.

# TABLE OF CONTENTS

<b>CHAPTER 1: WATER SYSTEMS OVERVIEW</b>		<b>SAMPLING SCHEULES &amp; TECHNIQUES</b>	4-1
MEETING WATER SYSTEM DEMANDS	1-1	<b>REPORTING &amp; SHIPPING CONSIDERATIONS</b>	4-2
SOURCES OF SUPPLY	1-1	TABLE 4.1 BAC-T SAMPLE FORM	4-2
MEETING WATER QUALITY STANDARDS	1-1	<b>RETAKES &amp; VIOLATIONS</b>	4-2
MEETING WATER CONSUPTION & PEAK DEMANDS	1-2	<b>STUDY &amp; SAMPLE TEST QUESTIONS</b>	4-3
COMPONENTS OF A WATER SYSTEM	1-2		
SERVICES	1-2	<b>CHAPTER 5: DISINFECTION</b>	
OPERATOR RESPONSIBILITIES	1-3	<b>TYPES OF DISINFECTION</b>	5-1
STUDY & SAMPLE TEST QUESTIONS	1-3	<b>CHLORINE TREATMENT TERMS</b>	5-1
		<b>DISINFECTION REQUIREMENTS</b>	5-2
<b>CHAPTER 2: SAFE DRINKING WATER ACT</b>		<b>BREAKPOINT CHLORINATION</b>	5-2
<b>PUBILC WATER SYSTEMS</b>	2-1	FIGURE 5.1 BREAKPOINT CURVE	5-2
<b>PRIMARY CONTAMINANTS</b>	2-1	<b>TESTING FOR CHLORINE RESIDULAS</b>	5-3
TABLE 2.1 PRIMARY CONTAMINANTS	2-2	<b>GENERAL CHLORINE SAFETY</b>	5-3
TABLE 2.2 INORGANIC CONTAMINANTS	2-2	TABLE 5.1 CHLORINE SYMPTOMS	5-3
TABLE 2.3 PRIMARY CONTAMINANTS	2-2	FIGURE 5.2 CHLORINE CYLINDER VALVE	5-4
<b>ORGANIC CONTAMINANTS</b>	2-2	<b>CHLORINATION EQUIPMENT</b>	5-5
TABLE 2.4 RADIOACTIVE CONTAMINANTS	2-2	FIGURE 5.3 GAS CHLORINE INSTALLATION	5-5
<b>RADIOACTIVE CONTAMINANTS</b>	2-2	FIGURE 5.4 CROSS SECITON OF A 1-TON CYLINDER	5-5
<b>BACTERIOLOGICAL CONTAMINANTS</b>	2-2	FIGURE 5.5 150 LB CHLORINE GAS FEED UNIT	5-6
<b>SECONDARY CONTAMINANTS</b>	2-3	TABLE 5.2 TROUBLESHOOTING GAS CHLORINATORS	5-7
<b>MONITORING &amp; REPORTING</b>	2-3	FIGURE 5.6 TYPICAL HYPOCHLORINATION SYSTEM	5-7
<b>BACTERIOLOGICAL VIOLATIONS</b>	2-3	<b>EMERGENCY RESPONSE PROCEDURES</b>	5-7
<b>ACTION PLAN FOR VIOLATIONS</b>	2-3	<b>ULTRAVIOLET LIGHT</b>	5-8
<b>OTHER NEW REGULATIONS</b>	2-4	TABLE 5.3 EMERGENCY RESPONSE PLAN	5-8
<b>STUDY &amp; SAMPLE TEST QUESTIONS</b>	2-4	FIGURE 5.7 UV DISINFECTION SYSTEM	5-8
		<b>STUDY &amp; SAMPLE TEST QUESTIONS</b>	5-9
<b>CHAPTER 3: INTRODUCTION TO DRINKING WATER</b>		<b>CHAPTER 6: FLUORIDATION</b>	
<b>WHAT IS WATER?</b>	3-1	<b>FLUORIDE FEED SYSTEMS</b>	6-1
FIGURE 3.1 THE WORLD'S WATER	3-1	FIGURE 6.1 FLUORIDE FEED SYSTEMS	6-1
FIGURE 3.2 WATER MOLECULE	3-1	<b>SODIUM FLUORIDE SATURATORS</b>	6-1
<b>DISTRIBUTION OF WATER ON EARTH</b>	3-2	FIGURE 6.2 SODIUM FLUORIDE SATURATOR	6-2
<b>HYDROLOGIC CYCLE</b>	3-3	<b>MONITORING FLUORIDE CONCENTRATIONS</b>	6-2
FIGURE 3.3 THE HYDROLOGIC CYCLE	3-3	<b>STUDY &amp; SAMPLE TEST QUESTIONS</b>	6-3
<b>DISTRIBUTION OF WATER</b>	3-5		
FIGURE 3.4 FRESH WATER	3-5	<b>CHAPTER 7: DISTRIBUTION</b>	
FIGURE 3.5 UNUSABLE FRESH WATER	3-5	<b>PIPED SYSTEM</b>	7-1
TABLE 3.1 LOCATION OF THE WORLD'S WATER	3-5	<b>MAIN LINE PIPING MATERIALS</b>	7-1
FIGURE 3.6 WATER DISTRIBUTION BY SYSTEM	3-6	FIGURE 7.1 DIP ON TRUCK	7-1
FIGURE 3.7 WATER DISTRIBUTION BY POPULATION	3-6	TABLE 7.1 PIPE TYPES	7-1
<b>STUDY &amp; SAMPLE TEST QUESTIONS</b>	3-6	FIGURE 7.2 RUBBER RING PUSH-ON JOINT	7-2
		FIGURE 7.3 MECHANICAL JOINT	7-2
<b>CHAPTER 4: WATER SAMPLING</b>		FIGURE 7.4 ASBESOS CEMENT (A.C.) PIPE	7-2
<b>NEW MEXICO CONSERVATION FEE</b>	4-1	FIGURE 7.5 AC COUPLING	7-2
<b>WATERBORNE PATHOGENTS</b>	4-1	FIGURE 7.6 DRESSER TYPE COUPLING	7-3
FIGURE 4.1 WATERBORNE DISEASES	4-1	FIGURE 7.7 STEEP PIPE, DIPPED AND WRAPPED	7-3
<b>COLIFORM GROUP OF BACTERIA</b>	4-1	FIGURE 7.8 PVC - INTEGRAL BELL & SPIGOT	7-3

FIGURE 7.9 PVC INTEGRAL BELL CROSS-SECTION	7-4	<b>CHAPTER 9: PUMPS &amp; MOTORS</b>	
FIGURE 7.10 CROSS-SECTION OF PRETENSIONED CONCRETE CYLINDER PIPE JOINT	7-4	<b>CENTRIFUGAL PUMPS</b>	9-1
FIGURE 7.11 HDPE HEAT FUSED WELDED JOINT	7-5	FIGURE 9.1 IMPELLER ROTATION & CENTRIFUGAL FORCE	9-1
<b>BEDDING &amp; BACKFILLING THE PIPE</b>	7-6	TABLE 9.1 PUMP CHARACTERISTICS OVERVIEW	9-1
FIGURE 7.12 PIPE BEDDING	7-6	FIGURE 9.2 HORIZONTAL SPLIT CASE CENTRIFUGAL PUMP	9-2
FIGURE 7.13 BACKFILLING THE PIPE	7-6	FIGURE 9.3 END-SUCTION CENTRIFUGAL PUMP	9-3
<b>PIPE PRESSURE RATINGS</b>	7-7	FIGURE 9.4 VERTICAL TURBINE CENTRIFUGAL PUMP	9-4
<b>SEPARATION OF WATER &amp; SEWER LINES</b>	7-7	FIGURE 9.5 SHAFT SLEEVE	9-4
<b>CLEANING WATER LINES</b>	7-7	FIGURE 9.6 PUMP BEARINGS	9-4
FIGURE 7.14 LAUNCHING A PIG	7-6	FIGURE 9.7 THE VOLUTE	9-5
<b>WATER LINE REPAIRS</b>	7-7	FIGURE 9.8 SUCTION PIPING	9-5
<b>DISINFECTION OF WATER LINES</b>	7-8	FIGURE 9.9 LEAK BACK	9-5
<b>DISTRIBUTION SYSTEM VALVES</b>	7-9	FIGURE 9.10 STUFFING MATERIAL	9-6
TABLE 7.2 VALVE MAINTENANCE	7-9	FIGURE 9.11 SEAL WATER	9-6
FIGURE 7.15 NON-RISING STEM GATE VALVE	7-9	FIGURE 9.12 STUFFING BOX CROSS-SECTION	9-6
FIGURE 7.16 BUTTERFLY VALVE	7-9	<b>PUMP HYDRAULICS</b>	9-7
FIGURE 7.17 ALTITUDE VALVES	7-10	FIGURE 9.13 MECHANICAL SEAL COMPONENTS	9-7
<b>FIRE HYDRANTS</b>	7-11	FIGURE 9.14 HOW TO DETERMINE TOTAL HEAD	9-7
FIGURE 7.18 FIRE HYDRANTS	7-11	FIGURE 9.15 PUMP CURVE	9-8
<b>SERVICE LINES</b>	7-12	FIGURE 9.16 HOW TO DETERMINE SHUT-OFF HEAD	9-9
FIGURE 7.19 SERVICE LINE INSTALLATION	7-12	<b>COMMON OPERATIONAL PROBLEMS</b>	9-9
<b>WATER METERS</b>	7-12	TABLE 9.2 CAUSES OF CAVITATION	9-9
FIGURE 7.20 TYPES OF METERS	7-13	<b>ELECTRIC MOTORS</b>	9-10
<b>READING METERS</b>	7-13	<b>STUDY &amp; SAMPLE TEST QUESTIONS</b>	9-11
FIGURE 7.21 WATER METER DIAL	7-13		
TABLE 7.3 LOST WATER	7-13	<b>CHAPTER 10: MECHANICAL SYSTEMS</b>	
<b>DISTRIBUTION SYSTEM HYDRAULICS</b>	7-14	<b>PUMP MAINTENANCE</b>	10-1
FIGURE 7.22 THRUST RESTRAINTS	7-14	<b>PUMP PACKING</b>	10-1
TABLE 7.4 FRICTION LOSS	7-14	TABLE 10.1 DAMAGES CAUSED BY PACKING FAILURE	10-1
<b>CORROSION CONTROL</b>	7-15	<b>BEARING MAINTENANCE</b>	10-2
FIGURE 7.23 BAYLIS CURVE	7-15	FIGURE 10.1 REPACKING A PUMP	10-3
<b>CROSS CONNECTION CONTROL</b>	7-16	<b>COUPLINGS</b>	10-4
FIGURE 7.24 BACKPRESSURE WITH BOILERS	7-16	FIGURE 10.2 GEAR COUPLING	10-4
FIGURE 7.25 AIR GAP	7-17	FIGURE 10.3 FLEXIBLE GRID COUPLING	10-4
FIGURE 7.26 ATMOSPHERIC VACUUM BREAKER	7-17	<b>ALIGNMENT</b>	10-4
FIGURE 7.27 DOUBLE CHECK VALVE	7-18	FIGURE 10.4 TYPES OF MISALIGNMENT	10-4
FIGURE 7.28 RPZ DEVICE	7-18	<b>INSTRUMENTATION</b>	10-4
<b>STUDY &amp; SAMPLE TEST QUESTIONS</b>	7-19	<b>CHEMICAL FEED SYSTEMS</b>	10-5
<b>CHAPTER 8: WATER STORAGE</b>		FIGURE 10.5 GRAVIMETRIC CHEMICAL FEEDER	10-5
<b>WATER STORAGE</b>	8-1	FIGURE 10.6 FEEDBACK CONTROL LOOP	10-5
<b>GROUND STORAGE TANKS</b>	8-1	FIGURE 10.7 VOLUMETRIC CHEMICAL FEEDER	10-6
FIGURE 8.1 SACRIFICIAL ANODES USED FOR CATHODIC PROTECTION	8-2	FIGURE 10.8 PERISTALTIC PUMP	10-6
<b>HYDROPNEUMATIC STORAGE</b>	8-2	FIGURE 10.9 DIAPHRAGM PUMP	10-6
FIGURE 8.2 TYPES OF PNEUMATIC TANKS	8-3	<b>STUDY &amp; SAMPLE TEST QUESTIONS</b>	10-7
FIGURE 8.3 DRAWDOWN	8-33		
<b>STUDY &amp; SAMPLE TEST QUESTIONS</b>	8-4		



## CHAPTER 11: GROUNDWATER & WELLS

<b>HYDROLOGIC CYCLE</b>	11-1
FIGURE 11.1 GROUNDWATER & THE HYDROLOGIC CYCLE	11-1
<b>WATER WELL LOCATION</b>	11-2
<b>WATER WELL CONSTRUCTION</b>	11-2
FIGURE 11.2 ARTESIAN & WATER TABLE AQUIFERS	11-3
<b>SANITARY PROTECTION OF THE WELL</b>	11-4
FIGURE 11.3 GROUTING A WELL CASING	11-4
<b>DEVELOPING A WELL</b>	11-4
<b>GRAVEL PACKED WELLS</b>	11-4
FIGURE 11.4 GRAVEL PACK WELL CONSTRUCTION	11-5
FIGURE 11.5 GRAVEL PACK WELL TYPES	11-5
<b>DISINFECTING WATER WELLS</b>	11-6
<b>WELL PUMPS</b>	11-6
FIGURE 11.6 VERTICLE TURBINE CENTRIFUGAL PUMP	11-7
FIGURE 11.7 SHAFT LUBRICATION SYSTEMS	11-8
<b>WELL SCREENS</b>	11-9
FIGURE 11.8 WELL SCREENS	11-9
<b>WELL HYDRAULICS</b>	11-9
FIGURE 11.9 WATER WELL HYDRAULIC TERMS	11-10
<b>MEASURING STATIC &amp; PUMPING LEVELS</b>	11-10
FIGURE 11.10 MEASURING STATIC & PUMPING LEVELS	11-11
<b>THE WELL LOG</b>	11-11
TABLE 11.1 WELL LOG DATA	11-11
<b>TROUBLESHOOTING WELL PROBLEMS</b>	11-11
FIGURE 11.11 WATER PROBLEM - CLOGGED SCREEN	11-12
FIGURE 11.12 WATER PROBLEM - SAND BRIDGING	11-12
<b>CLEANING INCRUSTED WELL SCREENS</b>	11-12
<b>PUMP RELATED PROBLEMS</b>	11-13
FIGURE 11.13 WATER PROBLEM - MECHANICAL PUMP	11-13
TABLE 11.2 FORCES THAT CAUSE SHAFT STRETCH	11-13
TABLE 11.3 WELL TROUBLESHOOTING FLOW CHART	11-14
TABLE 11.4 TROUBLESHOOTING WELL PUMPS	11-15
<b>STUDY &amp; SAMPLE TEST QUESTIONS</b>	11-16

## CHAPTER 12: SURFACE WATER

<b>SURFACE WATER SOURCES</b>	12-1
<b>INTAKE STRUCTURES</b>	12-1
FIGURE 12.1 LAKE INTAKE STRUCTURE	12-2
<b>SURFACE WATER QUALITY</b>	12-2
<b>SOLUBILITY OF SALTS</b>	12-3
TABLE 12.1 CHEMICAL NAMES & SYMBOLS	12-3
TABLE 12.2 WATER TREATMENT CHEMICALS	12-3
<b>PH</b>	12-4
FIGURE 12.2 pH SCALE	12-4
<b>PHYSICAL / CHEMICAL TREATMENT</b>	12-4
<b>REMOVAL OF COLOR</b>	12-5
<b>REMOVAL OF BACTERIA</b>	12-5
<b>REMOVAL OF TASTE AND ODORS</b>	12-5
TABLE 12.3 HARDNESS COMPOUNDS	12-6
<b>IN-PLANT TREATMENT</b>	12-6
<b>REMOVAL OF MINERALS</b>	12-6
SOFTENING CHEMICAL REACTIONS	12-7
OTHER SOFTENING PROCEDURES	12-8
<b>OTHER MINERAL PROBLEMS</b>	12-9
<b>CONTROL OF TURBIDITY AND COLOR</b>	12-9
FIGURE 12.3 CONVENTIONAL WATER TREATMENT PLANT DIAGRAM	12-10
TABLE 12.4 SETTLING RATES	12-10
FIGURE 12.4 HYDROPHOBIC PARTICLES	12-10
FIGURE 12.5 HYDROPHILLIC PARTICLES	12-11
<b>COAGULATION - THEORY</b>	12-11
FIGURE 12.6 ALUM IN WATER	12-11
FIGURE 12.7 POLYELECTROLYTE	12-12
FIGURE 12.8 JAR TEST APPARATUS	12-12
<b>PRETREATMENT EQUIPMENT</b>	12-13
FIGURE 12.9 STATIC IN-LINE MIXER	12-13
<b>COAGULATION EQUIPMENT</b>	12-13
FIGURE 12.10 DUAL COMPARTMENT RAPID MIX	12-13
<b>FLOCCULATION EQUIPMENT</b>	12-13
FIGURE 12.11 TYPES OF FLOCCULATORS	12-14
<b>SEDIMENTATION EQUIPMENT</b>	12-14
FIGURE 12.12 FOUR ZONES OF A SEDIMENTATION BASIN	12-15
FIGURE 12.13 RECTANGULAR SEDIMENTATION BASIN	12-15
FIGURE 12.14 CIRCULAR SEDIMENTATION BASIN	12-15
<b>UP-FLOW CLARIFIERS</b>	12-16
FIGURE 12.15 UP-FLOW CLARIFIER	12-16
<b>FILTRATION EQUIPMENT</b>	12-16
FIGURE 12.16 PRESSURE FILTER	12-17
FIGURE 12.17 SLOW SAND FILTER	12-17
FIGURE 12.18 FILTER UNDERDRAIN SYSTEM	12-18
FIGURE 12.19 WHEELER FILTER BLOCK	12-18
FIGURE 12.20 LOSS OF HEAD GAUGE	12-18
FIGURE 12.21 TYPICAL FILTER CONSTRUCTION	12-19

<b>FILTER OPERATION</b>	12-19
<b>FILTER BACKWASH PROCEDURES</b>	12-19
FIGURE 12.22 FILTER BACKWASH	
VALVE POSITIONS	12-20
<b>TROUBLESHOOTING FILTER PROBLEMS</b>	12-20
<b>CLEANING FILTER BEDS</b>	12-21
<b>HIGH RATE FILTERS</b>	12-21
FIGURE 12.23 FILTER MEDIA CONFIGURATIONS	12-21
<b>STUDY &amp; SAMPLE TEST QUESTIONS</b>	12-22
<b>CHAPTER 13: SAFETY</b>	
<b>LOCK OUT / TAG OUT (LOTO)</b>	13-1
<b>CONFINED SPACE ENTRY</b>	13-1
<b>HAZARD COMMUNICATION STANDARD</b>	13-2
<b>NFPA COLOR-CODE WARNING SYSTEM</b>	13-2
TABLE 13.1 MSDS SECTIONS	13-2
TABLE 13.2 OTHER HAZARD SYMBOLS	13-2
<b>EXCAVATION SAFETY</b>	13-2
<b>STUDY &amp; SAMPLE TEST QUESTIONS</b>	13-3
<b>CHAPTER 14: MATHEMATICS</b>	
<b>PRESSURE</b>	14-1
<b>AREAS</b>	14-2
<b>VOLUMES</b>	14-2
<b>VOLUMES IN GALLONS</b>	14-2
<b>VOLUMES OF PONDS</b>	14-2
<b>VELOCITY</b>	14-2
<b>DETENTION TIME</b>	14-3
<b>DOSAGE</b>	14-3
<b>STUDY &amp; SAMPLE TEST QUESTIONS</b>	14-6

# CHAPTER 1: WATER SYSTEMS OVERVIEW

---

Water systems today are finding themselves with ever increasing responsibilities in the area of proper treatment and protection of the water supply. The impact on small systems can be substantial. It is more important than ever to make sure the people who run these systems have better understanding of their system's operation.

The basic responsibility of the system is to provide each individual with an adequate supply of safe, potable drinking water. This responsibility extends to all employees; whether on a managerial, supervisory, operational, or clerical level, in some direct or indirect manner. Each employee should be aware of their duties and call to their supervisor's attention any condition that might impair water quality or cause service interruption to any part of the system. These responsibilities can be broken down into three major areas of concern:

1. **Providing enough water to meet the total demands of the system.**
2. **Providing water that is both safe and palatable to the customers.**
3. **Providing that water to the customer when it is needed.**

## MEETING WATER SYSTEM DEMANDS

The amount of water used by the entire system is known as the demand placed on that system. This demand may come from several different sources.

### DOMESTIC WATER USAGE

Domestic water usage is any water that is used directly by people in their daily activities. These activities include bathing, drinking, cooking, sanitation and other miscellaneous activities like watering lawns, washing the car and laundry. Two major factors that determine the domestic water demands placed on a system are one, the number of individuals the system serves and secondly the amount of water each person on the system will need per day. On a nationwide basis, the average daily consumption of water (total gallons used divided by the total population) is about 130 gallons per person per day. However, this figure will vary depending on the geographic location involved and the population density of that area. Rural areas tend to have a daily consumption rate lower than the national average, while urban areas may have a higher rate.

### INDUSTRIAL WATER USAGE

Industrial usage of water is considered to be water used for production of goods for marketing. The primary sources of industrial demands in rural areas is dairies, food processing, wood products, and textiles. A single industrial

user may require as much water as the entire domestic demand on the system.

### AGRICULTURAL WATER USAGE

Agricultural usage of water is considered to be water used in irrigating crops, watering livestock, and in cooling and cleanup of dairies and farm equipment. Agricultural demand will generally represent a larger portion of the total water usage than the industries in rural areas.

### PUBLIC WATER USAGE

Public water usage may be defined as any community service that requires potable water. Services may include fire protection, recreation (swimming pools, golf courses, etc.) and street maintenance. In rural communities where these services are limited, public water usage may not be a consideration.

Present conditions and future increases in water production should be considered when designing the system. Operators may not be concerned with the original design of the system but should be aware of the impact of new additions and extensions to the system. This is especially true in areas where present water mains are handling maximum capacities.

### SOURCES OF SUPPLY

Finding enough water to satisfy the demand on the system is the certainly a major concern for the water supplier. The legal and financial considerations that arise when trying to procure water rights or finance the capital funding required to construct treatment facilities can limit the options available in many cases.

Systems are faces with essentially two choices when selecting a source of supply. They can drill wells and use ground water or, if a suitable river or lake is present, they may choose to use a surface water supply.

### MEETING WATER QUALITY STANDARDS

Prior to 1976, water quality was regulated by individual state standards. In many cases these standards were only recommendations rather than enforceable regulations. The U.S. Congress passed the Safe Drinking Water Act (P.L. 93-523) in 1976. The law sets permissible levels of substances found in water which could be hazardous to public health. These regulations include Maximum Contaminant Levels or MCL, for inorganic and organic chemicals, radioactivity, turbidity and microbiological levels. Testing and monitoring requirements, reporting and

record keeping schedules, and public notification are enforced by individual state agencies.

## **MEETING WATER CONSUMPTION AND PEAK DEMANDS**

Peak water consumption periods will vary daily according to seasons and geographic locations. The major responsibility of the operator is to make sure the water is available when it is needed.

### **SEASONAL DEMANDS**

The amount of water used each day will generally vary according to the time of year. Higher daily demands occur during the hot summer months while the demand will tend to drop off during the winter months. Fluctuations in temperature and rainfall may also dictate a rise or fall in daily water consumption.

### **DAILY PEAK DEMANDS**

Ninety percent of the daily water usage will occur during a 16-hour period. The peak demand periods occur between the early hours of the morning, (5am to 10am) and the early evening hours, (5pm to 10pm.) Demand will usually increase earlier in rural areas. In urban areas, peak demands will be higher during the week while in rural areas the highest peak demands occur on weekends.

## **COMPONENTS OF A WATER SYSTEM**

Water systems are made up of a number of devices that are used to deliver water to the customer. The major components can be divided into the areas of the source of water, its treatment, and its distribution.

### **WATER SOURCES AND TREATMENT**

The source of water can be from groundwater, surface water, or water purchased from another water system. Usually the source of your water will determine the type of treatment necessary. In most circumstances, groundwater requires little treatment. Groundwater quality problems include: minerals, hardness, and dissolved gasses. Surface water typically requires extensive treatment. Surface water quality issues are: turbidity, taste & odor, and color. Surface water usually requires chemical treatment and filtration.

### **DISTRIBUTION AND TRANSMISSION WATER MAINS**

Main lines transport water from the source or from the treatment facility to the area to be served. These pipes are usually the largest in the system. They also serve as feeder lines for those users who are located along them.

## **SERVICES**

Services are small lines (usually 1" or 3/4") that carry water from the main line to the water user. The service connection includes:

1. Some means of tapping the main line or feeder line.
2. A corporation stop for turning the water off at the main or feeder line.
3. Service pipe or tubing.
4. Some type of meter setter which includes a meter stop.
5. Water meter.
6. A fitting for the water customer's connection.

## **PUMPS**

Pumps are used to move raw water from the source into the treatment facility or from the well into the system. They are also used to move treated water from the treatment facility into the system. Pumps are used to create pressure for the system and to fill the water storage facilities.

## **STORAGE TANKS**

Storage tanks hold a reserve of water for those times when the demand for water is greater than can be supplied by the trunk line or by the pumps. They also provide water for fire protection and for those times when the supply might be interrupted.

## **CONTROLS**

Automatic pump controls sense pressure on the system and turn the pump on when the pressure falls below a desired point or when the water level in the water tower drops below a certain level. When the water level in the tower has been restored or when the system's pressure has been raised to normal, the controls automatically turn the pump off. Pump controls can also turn the pump off, if alarm conditions occur. These types of alarm conditions include; high discharge pressure, motor overload, high motor or bearing temperatures, or low suction pressure.

## **ISOLATION VALVES**

Isolation valves are used throughout the system to stop the flow of water. They are usually gate valves or butterfly valves. The trunk line would have at least one isolation valve per mile of line in small rural systems and in large municipal systems they may need to be located every 300-600 feet. Each branch line should have an isolation valve at the point of connection to the trunk line. The proper location of these valves is important in order to isolate small sections of line for repair. This minimizes the number of customers that are out of water during times when repairs are being made.

## CONTROL VALVES

Control valves are designed to control flows or pressures in the system. There are a number of different applications for the control valves that may be used in the system. They are usually diaphragm operated globe valves that are controlled by hydraulic pilot systems. Here are some of the applications for control valves in a water system:

1. Pressure reducing valves - These valves are used to drop the pressure in a distribution zone in order to avoid damage to the system.
2. Pressure relief valves - These valves are used to “bleed” water from the system when the pressures reach a point that could result in damage to the system.
3. Altitude valves - These valves are used when two or more storage tanks are on the same main line. An altitude valve will isolate the lower tanks and prevent them from overflowing while the other tanks are filling.
4. Pressure sustain/flow limiting valves - These valves are used to limit the amount of flow to a certain portion of the system when it drops the pressure in other sections below a certain point.
5. Pump control valves - These valves are designed to replace check valves on booster pumps. They are closed when the pump starts and open slowly to minimize surges in the system. They also close before the pump stops.

## SURGE TANKS

Surge tanks act as pressurized shock absorbers in the system. They dissipate the pressure spikes caused by water hammer. Water hammer occurs when waves of high/low pressure occur, usually by opening or closing valves too fast. Water hammer can damage piping.

## FIRE HYDRANTS

Fire hydrants allow fire-fighting equipment to draw a large volume of water from the system quickly. They may also be used as sampling sites, flushing stations, and vent points for filling drained lines.

## OPERATOR RESPONSIBILITIES

An operator is the person who is, in whole or part, responsible for the operation of a water system. At times, he/she may be a manager, laboratory technician, mechanic, meter reader, public relations person, troubleshooter, or inspector. Becoming a competent operator requires the development of many skills. To become a competent operator one must have an interest in his/her work, be dependable, be willing to learn, and be willing to assume responsibility and work without supervision.

Each water utility represents a large financial investment in facilities and equipment and improper operation and maintenance can quickly damage both. Although much of

a water system is “out of sight”, it should always be on the mind of the operator. A competent operator provides a large degree of protection for both the tremendous financial investment and the health of the community.

## References

- Office of Water Programs, California State University, Sacramento, *Water Treatment Plant Operation*, Volume 1, 4<sup>th</sup> ed., Chapter 1
- Office of Water Programs, California State University, Sacramento, *Water Distribution System O&M*, 4<sup>th</sup> ed., Chapter 1.
- Office of Water Programs, California State University, Sacramento, *Small Water System O&M*, 4<sup>th</sup> ed., Chapter 1
- 

## BASIC STUDY QUESTIONS

1. What are wear rings?
2. What are two types of misalignment?
3. What happens when you increase the pressure on a centrifugal pump?
4. What are some of the possible causes of cavitation?
5. What does single phasing in a three-phase motor mean?

## BASIC SAMPLE TEST QUESTIONS

1. A lantern ring:
  - A. Must be located in line with the seal water port
  - B. Is used to allow cooling water into the center of the stuffing box
  - C. Will be found in the stuffing box
  - D. All of the above
2. The discharge piping of a centrifugal pump will be larger than the suction piping.
  - A. True
  - B. False

## ADVANCED STUDY QUESTIONS

1. What is one of the most frequent causes of vibration problems in lift station pumps and motors?
2. What is the best way to prevent loss of prime?
3. What are four conditions that could cause cavitation in a centrifugal pump?
4. How do you reverse the rotation of a three-phase motor?
5. What kind of information is found on a pump curve?

BLANK PAGE

## CHAPTER 2: SAFE DRINKING WATER ACT

The Federal Safe Drinking Water Act (PL93-523) was enacted in 1974 and went into effect in 1976. The purpose of the Act is to establish national enforceable standards for drinking water quality and to guarantee that water suppliers monitor water to ensure that it meets national standards. This Act established either the maximum concentration of pollutants allowed in, or the minimum treatment required for, water that is delivered to the customers. These substances are known to present adverse health effects to humans. Prior to the passage of PL93-523 standards were set by the individual state regulatory agencies. The limits and enforcement procedures varied from state to state and, in passing the law, Congress has attempted to assure uniformly safe drinking water for the general public. The SDWA was amended in 1986 and again in 1996.

Each state (or tribal government), except Wyoming and the District of Columbia, has primacy regarding the enforcement of the standards. The New Mexico Environment Department is the enforcement agency for New Mexico. All sampling and reporting, except for non-Tribal and Federal systems, is handled through the NMED.

### PUBLIC WATER SYSTEMS

The regulations established in PL93-523 apply only to public water systems. A public water system is any system that contains 15 service connections, residential or serves 25 people regularly. These systems are responsible for both complying with these regulations and reporting to the public when any standards are exceeded. Public water systems can include private schools, interstate rest stops, state parks, and even restaurants.

### PRIMARY CONTAMINANTS

The SDWA identified a number of chemicals and microorganisms that are found in drinking water supplies. Because excessive amounts of some of these substances

have been determined or anticipated to cause adverse health effects they are referred to as primary contaminants. These substances can be grouped into four major categories: Inorganic chemicals, organic chemicals, radioactive chemicals, and waterborne bacteria. (See Table 2.1.)

### MAXIMUM CONTAMINANT LEVELS (MCL)

The maximum amount of any one of these substances that can be allowed in water, according to the regulations, is known as the maximum contaminant level (MCL). The MCLs for these chemicals and compounds are set at levels that are considered to be many times less than the concentrations that are known, or anticipated to cause adverse health effects.

### INORGANIC CONTAMINANTS

These contaminants are mostly heavy metals. They may enter the water supply naturally through ground water formations or from mining runoff and industrial discharges. The MCL for each chemical is listed Table 2.2.

### LEAD AND COPPER RULE

A representative sampling survey must be conducted for lead and copper that may be present at the customers' tap. Most of the lead and copper found this way comes from the customers' plumbing. The system will be responsible for treating the water to stabilize the corrosive qualities that cause the leeching of lead and copper from plumbing. Sampling for lead and copper requires taking a "first draw" sample from a customer's tap, after water has been standing in the plumbing for at least 6 hours but no longer than 18 hours. If the 90th percentile results exceed the action levels for either metal, the system must take steps to stabilize the system water through chemical addition of lime or another form of alkalinity.

### NITRATES

Nitrates are the only chemical contaminant that represent an immediate health risk. Pregnant mothers and infants under 18 months can develop a condition known as "Blue Baby Syndrome". The presence of nitrates in the bloodstream reduces oxygen uptake that gives the skin a blue tint.

### FLUORIDE

Fluoride is added to water to help prevent tooth decay. The optimum dosage for fluoride is 0.8-1.2 mg/l. However, at higher concentrations, fluoride can create stains on teeth and lead to brittle bones in older individuals. The average ambient air temperature for the system is used to determine the optimum dosage for fluoride.

Primary Contaminants
(1) Inorganic Chemicals
(2) Organic Chemicals
(3) Radioactive Chemicals
(4) Waterborne Bacteria

Table 2.1 - Primary Contaminants

<b>Inorganic Contaminant</b>	<b>MCL (mg/l)</b>
Antimony	0.006
Arsenic	0.05
Barium	2.0
Beryllium	0.004
Cadmium	0.005
Chromium	0.1
Cyanide	0.2
Mercury	0.002
Nickel	0.1
Selenium	0.05
Thallium	0.002
Copper	1.3* Action level
Lead	0.015* Action level
Nitrates (as N)	10.0
Total Nitrate & Nitrite (as N)	10
Nitrite (as N)	1.0
Fluoride	2.0 Public Notice 4.0 Violation
Turbidity	5 NTU (single occurrence) 1 NTU (< 5% of samples)
Asbestos	7,000,000 Fibers/L

**Table 2.2 - Inorganic Contaminants**

**TURBIDITY**

Turbidity is clay, silt or mud in the water. Although turbidity does not represent a health risk by itself, it can shield harmful bacteria from disinfection processes. Turbidity is measured in Nephelometric Turbidity Units (NTU). The device used to measure NTU's is called a nephelometer or turbidimeter.

**ORGANIC CONTAMINANTS**

These contaminants include herbicides and insecticides that are primarily used in agriculture applications, organic solvents used in industrial applications, organic by-products of industrial processes, and chemical by-products from chlorination of drinking water. Runoff from agricultural spraying or improper application techniques can be a major source of these contaminants in a surface water supply. Industrial discharges, accidental spills and improper disposal of hazardous wastes can also become sources of contamination.

These compounds are grouped together under the headings of Volatile Organic Compounds or VOC's and Synthetic Organic Compounds or SOC's. There are currently 21 regulated VOC's and 30 SOC's that must be analyzed. Some of the VOC's are listed in Table 2.3.

**RADIOACTIVE CONTAMINANTS**

Most radioactive substances occur naturally in ground water and in some surface supplies. Some man-made substances may also enter drinking water supplies from processing facilities, mining areas, and nuclear power plants. (See Table 2.4.)

<b>Radioactive Contaminant</b>	<b>MCL (pCi/l)</b>
Radium 226 and 228	5
Gross Alpha Activity	15
Gross Beta Activity (man-made)	4 millirem/yr

**Table 2.4 - Radioactive Contaminants**

<b>Organic Contaminant</b>	<b>MCL (mg/l)</b>
Benzene	0.005
Vinyl Chloride	0.002
Carbon Tetrachloride	0.005
Styrene	0.1
Total Trihalomethanes (TTHM)	0.1

**Table 2.3 - Organic Contaminants**

**BACTERIOLOGICAL CONTAMINANTS**

The coliform group of bacteria represents the indicator organisms used in determining bacteriological contamination. Their presence indicates the possibility that some pathogenic (disease causing) organisms may also be present. The MCL is exceeded when 5% of the required monthly routine (M/R) samples indicate the presence of Coliform bacteria. The presence of coliform in any sample will require three repeat samples be taken. These repeat samples must be taken within 24 hrs of notification of positive results.



The regulations state that, when repeats are required, a minimum of five (5) samples are now required for the month. This means that any small system that would normally only take one sample per month, will have to take four (4) repeats when they get a positive test result. If any system has to take repeat samples, it must also take a minimum of five (5) samples the following month.

## **SECONDARY CONTAMINANTS**

There are certain substances in water that, although they do not present serious health hazards, can cause temporary physical discomfort and make the water unsuitable for use. Each state may determine which of these standards are included in their regulations. Chlorides can make the water taste salty. This is also known as brackish water. Sulphates can cause minor gastro-intestinal problems. Iron and manganese can result in red or black water problems. The pH of the treated water can also create some digestive problems if it is very high or very low. Recommended levels for secondary contaminants are:

## **MONITORING AND REPORTING**

The public water systems are responsible for monitoring their water quality and reporting violations of the SDWA standards to the public. The New Mexico Environment Department is currently collecting and submitting samples to the laboratory for all public water supplies. The program is funded through a "Water Conservation Fee" of 3 cents per 1000 gallons paid by each system. However, the systems will still be responsible for the results of testing and any public notification that may be required. Systems must retain copies of chemical analysis records for 10 years and bacteriological tests results for 5 years.

## **SAMPLING SCHEDULES**

Samples used in testing for chemical and biological contaminants must be collected periodically. Samples for inorganic chemical analysis must be submitted once every year for surface supplies and once every three years for ground water supplies. Sampling for organic compounds is done quarterly for the initial set of samples. Surface water plants must also collect four TTHM samples quarterly during this initial period. After that, samples are collected yearly for surface water and every three years for ground water as long as no VOC's or SOC's are detected. If they are found, the source (well or surface supply) must be sampled every quarter. Radiological samples are taken every four years. Under the new Standardized Monitoring Rule, most chemical contaminants are monitored in a cycle of 3/6/9 years. Each three (3) year period is referred to as a compliance period. Bacteriological sampling schedules vary from state to state. A minimum of one sample per month is normally required for the smallest systems. As the population served increases so does the number of samples

required. Whenever compliance samples are submitted it is important to maintain a "chain of custody" that identifies who handled the sample from the time it was taken until it was tested.

## **BACTERIOLOGICAL VIOLATIONS**

When a positive BAC-T sample is reported repeat samples are required. If the repeats come back negative there is no violation. If more than 5% of the monthly samples are positive for Total Coliform (TC), including repeats, there is a non-acute violation that requires public notification. This means that any system taking less than 40 samples per month can only have 1 total coliform positive sample per month.

If a monthly routine sample is positive for TC and for fecal or E. Coli; and any repeat is positive for TC, OR if any of the repeats are positive for fecal coliform, or E. Coli, an acute violation has occurred that requires notification through the electronic media. This sometimes triggers a "Boil Order" advisory.

## **PUBLIC NOTIFICATION**

The water system will be required to notify the public any time maximum contaminant levels are exceeded. These violations of the standards fall into two categories: acute violations and non-acute violations.

A non-acute violation occurs when an MCL is exceeded but the situation does not present an immediate health risk to the public. In this case, notification must be placed on or with the billing notice within 45 days and must run in the newspaper within 14 days. In addition, all new customers must be sent notice of violations when they connect to the system. Acute violations are violations that could result in an immediate danger to the public health and therefore require immediate notification through television and radio stations within 72 hours. This is in addition to the newspaper and/or billing notifications. Public notification must continue until the problem is corrected. Notification must also be given to the NMED within 48 hours any time a system fails to comply with the NM Drinking Water Regulations.

## **ACTION PLANS FOR VIOLATIONS**

If a water supply exceeds the primary standards the water system must either provide adequate treatment to remove the contaminants or locate a new source of supply that meets these requirements.

## **VARIANCES AND EXEMPTIONS**

A system that is found to exceed the MCL for a primary contaminant may not be able to correct the problem for financial or technical reasons. Depending on the

circumstances, the system may be granted a variance or exemption. The fact that a variance or exemption has been granted does not mean that the system is no longer required to notify the public of the problem. Notification must continue on a monthly basis until the system meets the standard.

### **Variations**

A variance may be granted to a water system when its supply is found to exceed maximum standards and no technology is available to economically remove these contaminants. Variations may be extended at the discretion of the state regulatory agency if no treatment methods are made available during the period the variance is granted.

### **Exemptions**

When a system is unable to financially provide the necessary treatment to reduce contaminant levels to acceptable limits, an exemption can be granted to the water system. Exemptions are granted by state regulatory agencies only in cases where a serious health hazard is not present.

## **OTHER NEW REGULATIONS**

The 1986 amendments to the SDWA included a number of new rules regarding treatment and operations of public water supplies. The major changes are identified below with a brief description of the rule and its implications.

### **SURFACE WATER RULE**

Any system that uses surface water must provide treatment of the supply. The minimum acceptable level of treatment is filtration and disinfection. Infiltration galleries may now be considered surface supplies because they are groundwater that is under the influence of surface water. The concerns about contamination by *Giardia* and *Cryptosporidium* bacteria have created the need for higher free chlorine residuals and longer disinfection contact times.

The “CT” calculation is used to determine the necessary contact time at any given concentration. The formula is  $C \times T = A$ , where C is the chlorine concentration, T is the contact time in minutes, and A is a temperature-based constant. Removal of *Cryptosporidium* is based on a 3-log reduction of the numbers found in raw water. A 3-log removal or deactivation would mean that 0.1% of the bacteria may survive or 99.9% were removed. A 4- log removal or deactivation would mean that 0.01% of the organisms may survive or 99.99% were removed

### **DISINFECTION AND DISINFECTION BY-PRODUCTS RULE**

Systems that use chlorination may create TTHMs and halo acetic acids ( $HA_x$ ) as a by-product of disinfection.

If the creation of these by-products causes the system to exceed the MCL for Total TTHMs (0.1 mg/l or 100 ppb), the system will be required to change to a different means of disinfection. Total chlorine residuals are also limited to a maximum of 4.0 mg/l. The D-DBP rule currently only applies to systems serving a population over 10,000.

---

### *References:*

Office of Water Programs, California State University, Sacramento, *Water Treatment Plant Operation*, Volume 2, 4<sup>th</sup>ed., 1999, Chapter 22  
Safe Drinking Water Act  
NMED *Drinking Water Regulations*

---

## **BASIC STUDY QUESTIONS**

1. What is an MCL?
2. Why is turbidity a Primary Contaminant?
3. What is a nephelometer?
4. How much is the “Water Conservation Fee”?
5. How long must bacteriological and chemical sampling results be kept?

## **BASIC SAMPLE TEST QUESTIONS**

1. A public water system is any system that serves a population greater than or equal to:
  - A. 25
  - B. 50
  - C. 100
2. What is the maximum total chlorine residual allowed by the Disinfectant-Disinfection By-Products Rule?
  - A. 2 mg/l
  - B. 4 mg/l
  - C. 6 mg/l
  - D. 8 mg/l
3. What type of contaminant is iron?
  - A. Primary Inorganic
  - B. Primary Organic
  - C. Secondary
4. Which Primary Contaminant is sometimes added to water supplies to prevent tooth decay?
  - A. Iron
  - B. Arsenic
  - C. Fluoride
  - D. Mercury

5. The failure of a public water system to comply with the NM Drinking Water Regulations must be reported to NMED within:
  - A. 12 Hours
  - B. 48 Hours
  - C. 4 Days
  - D. One week
5. How many bacteriological samples must be taken every month before a system is allowed to have TWO positive samples without violating the drinking water standard?
  - A. 10
  - B. 20
  - C. 40
  - D. 60

### ADVANCED STUDY QUESTIONS

1. Which Primary inorganic contaminant poses an immediate health risk?
2. When you get a positive Total Coliform sample result, what is the minimum number of retakes required?
3. What are the action levels for lead and copper?
4. If bacteriological retakes are done this month, what is the minimum numbers of samples that must be turned in next month?
5. If a 3-log removal is required for *Giardia Lamblia*, what percentage of organisms can survive and still meet the requirement?

### ADVANCED SAMPLE STUDY QUESTIONS

1. The MCL for Total Trihalomethanes is:
  - A. 0.01 mg/l
  - B. 0.1 mg/l
  - C. 0.2 mg/l
  - D. 2.0 mg/l
2. SDWA sampling results must be reported to:
  - A. New Mexico Water Association
  - B. American Water Works Association
  - C. New Mexico Environment Department
3. Groundwater systems must sample for inorganic chemicals every:
  - A. Month
  - B. Day
  - C. Year
  - D. Three years
4. The SDWA Compliance Cycle for the Standardized Monitoring Rule consists of three:
  - A. Years
  - B. Compliance Periods
  - C. Quarters
  - D. Months



BLANK PAGE

## CHAPTER 3: INTRODUCTION TO DRINKING WATER SYSTEMS

### WHAT IS WATER?

Water is the most abundant and common material on earth. It covers 70% of the surface of the earth as water and ice.

#### Life Blood

Water is the life blood of the universe. If we were without water there could be no life. Our bodies are 70% water. Without drinking water for four to seven days our blood becomes thick and contains a high concentration of toxic waste materials. We become delirious and unable to function. Death is not far behind.

#### Other Planets

As far as we know, earth is the only planet in the solar system that contains water. Others have ice, but only earth has this miraculous life blood.

#### Universal Solvent

Water is often called the “universal” solvent. Given enough time it will dissolve almost everything that it comes in contact with. Thus, it is effective in carrying food through our bodies to the individual cells and carrying away the cell waste.

#### Dissolves Minerals

As water flows through the gravels, fissures and sands in the earth’s crust and flows over the top of the ground it picks up minerals, microorganisms<sup>1</sup>, dirt and bits of plants. Some of these materials are carried along by the water due to its speed. Others, such as minerals are dissolved in the water.

#### Gases

Water, like many other fluids, also has the ability to dissolve gases, such as oxygen (O<sub>2</sub>) and carbon dioxide (CO<sub>2</sub>). The oxygen in the water allows fish and other aquatic life<sup>2</sup> to live in the water. Without oxygen fish, like humans, would die. The gills of the fish allow it to filter this dissolved oxygen directly from the water.

### WATER AS A CHEMICAL

#### The Water Molecule

The water molecule<sup>3</sup> is composed of one atom of oxygen and two atoms of hydrogen. This molecule is given the chemical symbol H<sub>2</sub>O (H<sub>2</sub> for two hydrogen atoms and O for one oxygen atom). The chemical symbol is read as “H two O.”

**70% Water**



Figure 3.1 - The World’s Water

#### Like a Battery

Notice that the two hydrogen atoms are at one end of the molecule. The hydrogen atoms are positively charged. When they attach themselves to the oxygen molecule the whole molecule effectively becomes polarized with negative and positive poles, much like a battery. Because it has both negative and positive charges, it is much easier for it to attract other material. This is one of the reasons it is the “universal” solvent.

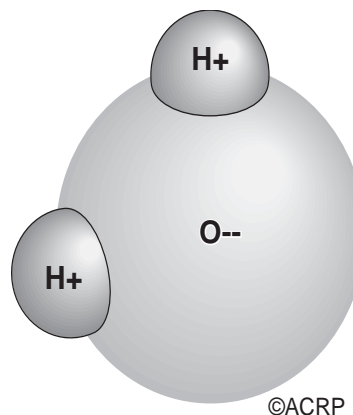

Figure 3.2 - Water Molecule

#### States of Water

Water has another unique property; it is the only material that is found on earth in the three basic states at standard temperatures. These states are solid (ice), liquid (water) and gas (water vapor).

<sup>1</sup> **Microorganisms** - Minute organisms, either plant or animal, invisible or barely visible to the naked eye.

<sup>2</sup> **Aquatic Life** - All forms of plant and animal life that live in water.

<sup>3</sup> **Molecule** - The smallest division that a substance can be broken down to without separating its individual atoms.

## **Molecules in Motion**

The water molecule, like other molecules, it is in constant motion. The rate of this motion is directly related to the temperature of the water. It moves slowest when the water is in the form of ice, and fastest when the water is a vapor.

## **Density of Water**

As the temperature is reduced the rate of movement slows. As this happens the molecules get closer and closer together. At 4°C they are as close together as they are ever going to be. This increases water's density<sup>4</sup> to its maximum. The volume that a set amount of water occupies is at a minimum at this point. Below 4°C the molecules are moving so slow that their electrical charges begin to cause the molecules to line up in a pattern and form crystals.

## **Expands When it Freezes**

At 0°C the crystals are fully formed. This formation allows the molecules to line up in a way so that they occupy a greater space than they did before the temperature reached 0°C. This expansion is what causes water to break a bottle or pipe when it is frozen. Water is one of the few compounds that expands when it freezes. This causes ice to be lighter than the same volume of water and therefore it floats in water.

## **Water and Heat**

The amount of heat it takes to cause the temperature of water to change is used as the basic measurement of heat. In the English system this heat is referred to as a BTU (British Thermal Unit). One BTU is defined as the amount of heat required to raise the temperature of one pound of water one degree Fahrenheit<sup>5</sup>. In the SI (System International - also called the metric system) the unit of heat is the calorie. One calorie is defined as the amount of heat required to raise one gram of water one degree Celsius<sup>6</sup>.

## **DISTRIBUTION OF WATER ON EARTH**

### **The Study of Water**

The study of water, its location, use, quantity and occurrence is called hydrology<sup>7</sup>. This next section is a brief discussion of the types of water sources, the distribution of water in

those sources and some of the uses of water. This is a small portion of hydrology.

### **DEFINITION BY SOURCES**

The sources of water on the earth are divided into two categories; surface water and groundwater<sup>8</sup>.

#### **Surface Water**

Surface water is water that is found in the oceans, lakes, streams, springs, and muskeg ponds. Surface water is exposed to the atmosphere<sup>9</sup> and is affected by ambient<sup>10</sup> conditions. This is the source of drinking water for some of our largest communities.

#### **Groundwater**

Groundwater is all the water below the earth's surface. However, from a waterworks standpoint we only consider the water between the surface and 2500 feet down. Water below this depth is too hot and expensive to be usable. Groundwater may also include springs. Yes, springs were included in the surface water description. That is because they can be either.

#### **70% of Earth is Water**

Seventy percent of the earth's surface is covered with water. The total volume of water on the earth is approximately 305.79 million cubic miles. Of this, 296 million cubic miles are in the oceans, leaving only 9.79 million cubic miles of fresh water.

---

<sup>4</sup> **Density** - The weight per unit volume of a substance.

<sup>5</sup> **Fahrenheit** - Relating to an English thermometer scale with the boiling point at 212 degrees and the freezing point at 32 degrees.

<sup>6</sup> **Celsius** - Relating to a thermometer scale used in the metric system on which the freezing point of water is 0 degrees and the boiling point is 100 degrees.

<sup>7</sup> **Hydrology** - The applied science pertaining to properties, distribution, and behavior of water.

<sup>8</sup> **Groundwater** - Subsurface water occupying a saturated geological formation from which wells and springs are fed.

<sup>9</sup> **Atmosphere** - The gasses that surround the earth.

<sup>10</sup> **Ambient** - The surrounding atmosphere.

## HYDROLOGIC CYCLE

The hydrologic cycle<sup>11</sup> is the key to our supply of fresh water. The cycle is made up of four key components.

- The atmosphere
- The lithosphere<sup>12</sup> - the crust of the earth
- The hydrosphere<sup>13</sup> - the water on the earth
- The sun - the energy source used to drive the hydrologic cycle

### Available Water Supply

The amount of water available in the atmosphere, lithosphere and hydrosphere remains constant. It was formed during the creation of the earth. There will never be any more or any less than there is today. This water is continually recycled between the lithosphere and the atmosphere by the action

of plants and the sun. In order to understand this process lets follow the cycle.

### Precipitation

You could start the cycle anywhere because it is continuous and has no beginning or ending. So lets pickup a droplet of precipitation and follow it through the cycle. Precipitation<sup>14</sup> in the form of rain, snow or sleet falls towards the earth.

### Fall Toward Earth

As the precipitation falls toward the earth it can pickup contamination in the form of minerals and toxic materials from industrial air pollution and natural pollution such as dust from a volcanic eruption. On its fall toward the earth some of the precipitation evaporates<sup>15</sup>.

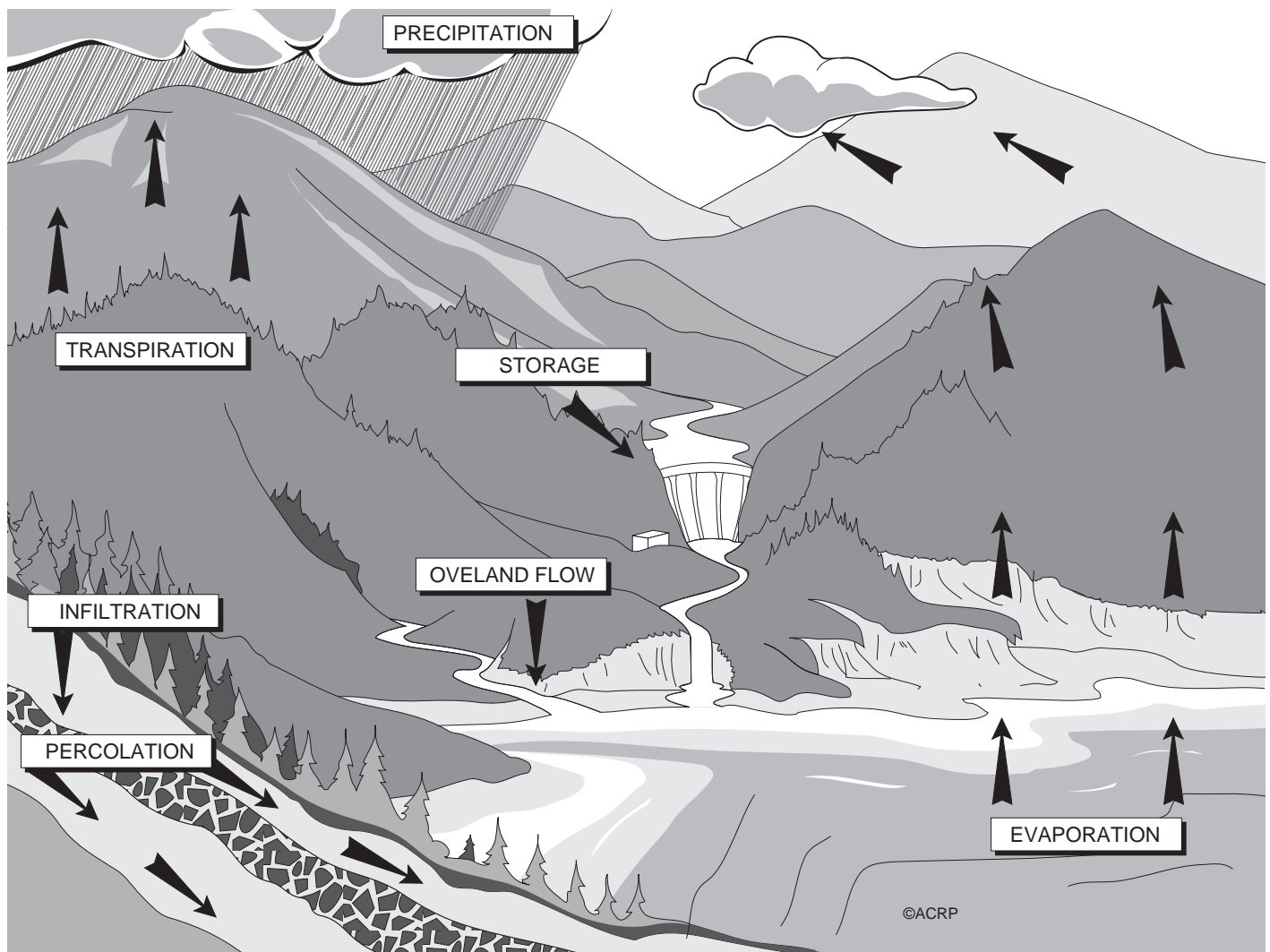

Figure 3.3 - The Hydrologic Cycle

<sup>11</sup> **Hydrologic Cycle** - Nature's method of continuously recycling the earth's renewable water supply, between the earth and atmosphere, making it possible to use this water over and over again.

<sup>12</sup> **Lithosphere** - The solid crust of the earth. It consists of the thin, loose layer known as soil and the mass of hard rock, several miles in thickness, upon which soil lies.

<sup>13</sup> **Hydrosphere** - All of the water on the earth.

## **Evaporation**

The amount of evaporation is dependent upon several factors. Among them are the humidity<sup>16</sup>, air temperature and the amount of wind. There is a significant amount of precipitation that is recycled back to the atmosphere before it ever strikes the ground.

## **Hits the Forest**

Some of the precipitation hits the forest canopy<sup>17</sup>, brush and grass. Some of the precipitation evaporates directly from the leaves of the canopy.

## **Hits the Ground**

Some water flows down the outside of the trees onto the ground, and some strikes the ground directly. As water accumulates on the ground it runs downhill. This movement is referred to as overland flow<sup>18</sup>.

## **Flow Along the Surface**

As the water moves along the surface it picks up contamination in the form of organic<sup>19</sup> material such as, bits of leaves, microorganisms such as bacteria<sup>20</sup>, viruses<sup>21</sup>, and protozoa<sup>22</sup>, and inorganic<sup>23</sup> matter such as silt, clay, minerals and volcanic ash.

## **Surface Water**

The overland flow accumulates in lakes, streams, muskeg ponds and rivers. Most rivers will eventually run into the ocean. These sources are referred to as surface water. A large quantity of the water that forms surface water will be evaporated back into the atmosphere. In fact in most of the world this is the largest single loss of surface water.

## **Groundwater**

Some of the water that is running along the earth's surface seeps into the soil. This process is called infiltration<sup>24</sup>. As the water infiltrates the soil and moves downward some is

taken up by the roots of trees and other plants. The water that is taken in by plants moves upward and is given off into the atmosphere through the leaves of the plants in a process called transpiration<sup>25</sup>.

## **Evaporation & Transpiration**

This moisture mixes with the moisture that is evaporated from surface waters and from the plants. This combined process is referred to as evapotranspiration<sup>26</sup>.

## **Groundwater Movement**

The water not taken up by plants continues to move downward in a process called percolation<sup>27</sup>. This water continues to move downward until it collects in gravels and sands called aquifers<sup>28</sup>. There the water continues to slowly move towards adjacent lakes, streams and the ocean where it collects with the surface water and is evaporated back into the atmosphere.

## **Springs**

Sometime in the past, changes in the earth's crust left the edge of an aquifer exposed to the surface. Where this happens the groundwater supply exits the hillside or mountain in what is referred to as a spring. From there it runs along the surface and mixes with surface water.

## **Back to the Atmosphere**

As you can see both the groundwater and the surface water eventually mix and are evaporated back into the atmosphere and form water vapor. This vapor is condensed by atmospheric conditions and forms precipitation which falls to the ground and the cycle is continued, providing us with clean fresh water for our water systems.

---

<sup>14</sup> **Precipitation** - The process by which atmospheric moisture is discharged onto the earth's crust. Precipitation takes the form of rain, snow, hail, and sleet.

<sup>15</sup> **Evaporate** - The process of conversion of liquid water to water vapor.

<sup>16</sup> **Humidity** - The amount of water vapor in the air.

<sup>17</sup> **Forest Canopy** - The enclosure made by the trees in a forest. The canopy can block all or most of the light from the forest floor.

<sup>18</sup> **Overland flow** - The movement of water on and just under the earth's crust.

<sup>19</sup> **Organic** - Chemical substances of animal or vegetable origin, usually containing carbon.

<sup>20</sup> **Bacteria** - Living organisms, microscopic in size, which consist of a single cell. Most bacteria utilize organic matter for their food and produce waste products as the result of their life processes.

<sup>21</sup> **Viruses** - A submicroscopic organism which passes through filters capable of removing bacteria.

<sup>22</sup> **Protozoa** - A small, one-celled animal including, but not limited to, amoebae, ciliates, and flagellates.

<sup>23</sup> **Inorganic** - Chemical substances of mineral origin, not usually containing carbon.

<sup>24</sup> **Infiltration** - The initial movement of water from the earth surface into the soil.

<sup>25</sup> **Transpiration** - The process by which water vapor is lost to the atmosphere from living plants.

<sup>26</sup> **Evapotranspiration** - The combined vaporization of water from surfaces and plants.

<sup>27</sup> **Percolation** - Movement of water into and through the ground.

<sup>28</sup> **Aquifer** - A porous, water-bearing geologic formation.



**DISTRIBUTION OF WATER**

**Total Supply**

The total supply of all water in the world is approximately 305.79 million cubic miles. Of this total supply 296 million cubic miles are in the worlds oceans. This leaves 9.79 million cubic miles or 3.2% of all water in the world as fresh water.

**Distribution of Fresh Water**

74.7% of the 9.79 million cubic miles of fresh water is tied up in the polar ice caps, soil moisture and atmosphere. 25% of this fresh water is in the groundwater supply, leaving 0.3% of the fresh water in the lakes and streams.

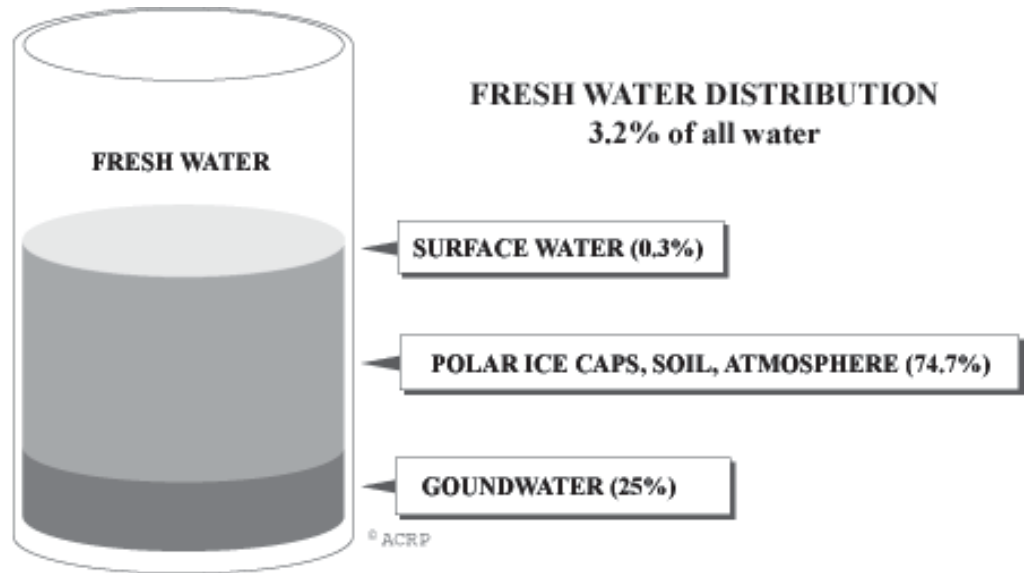

**Figure 3.4 - Fresh Water**

**Usable Fresh Water**

The total groundwater supply is estimated at 2.42 million cubic miles. Only 44% of this, or 1.06 million cubic miles, is usable. That is, it is less then 2,500 feet below the surface. The lakes and rivers represent 0.03 million cubic miles of fresh water. This gives a total of 1.09 million cubic miles of usable fresh water.

**Division of Fresh Water**

Of the usable fresh water, 97% or 1.06 million cubic miles is in the groundwater supply and only 0.3% is in the surface water supply.

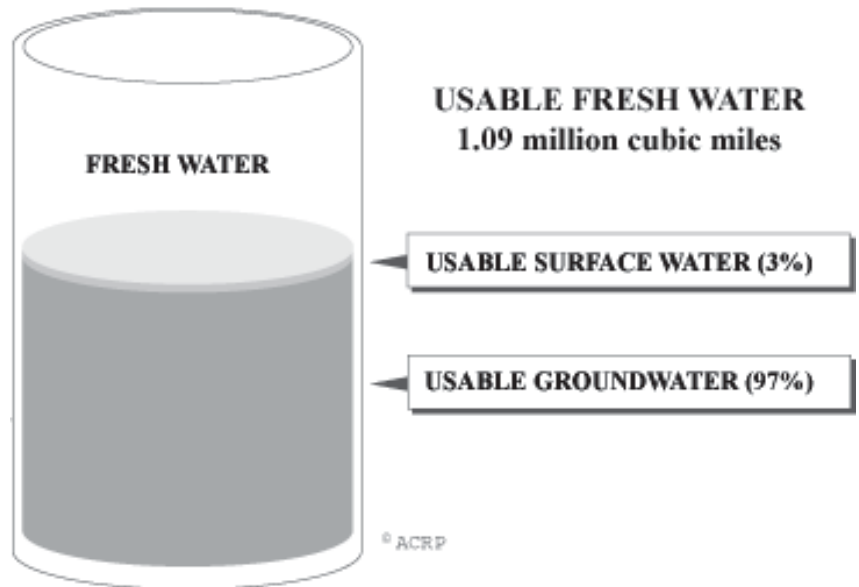

**Figure 3.5 - Useable Fresh Water**

**Table 3.1 - Location of the Worlds Fresh Water**

<b><u>Location by Per Cent of the Worlds Fresh Water</u></b>		
<b>%</b>	<b>LOCATION</b>	<b>MILLION CUBIC MILES</b>
74.60	Polar ice caps	7.33
0.06	Soil moisture	0.00587
0.035	Atmosphere	0.00342
14.00	Groundwater between 2,500 and 12,500 feet	1.36
11.00	Groundwater between 0 and 2,500 feet	1.06
0.30	Lakes	0.029
0.03	Streams & Rivers	0.00293

### DISTRIBUTION BY SYSTEM

Within the continental United States 77.3% of the public water systems use groundwater and 18% of the systems use surface water. 4.7% of the systems in the US use a combination of surface water and ground water.

### DISTRIBUTION BY POPULATION

Within the continental United States 68% of the population is served by surface water suppliers while only 32% of the population relies on groundwater supplies.

### WHY THE DIFFERENCE?

#### System Location

There are several reasons for the difference between the number of surface water suppliers and the number of people obtaining their drinking water from surface water suppliers. First, in the continental United States 37 of the 100 largest communities use surface water. This is because the majority of these communities are built next to surface water sources, including ten that are built next to the Great Lakes. In the West, communities such as Los Angeles, San Francisco, Portland and Seattle all utilize surface water.

#### Water Availability

Second, a large portion of this country is without any surface water source. Finally, there are few ground water supplies which can provide sufficient water for a large community.

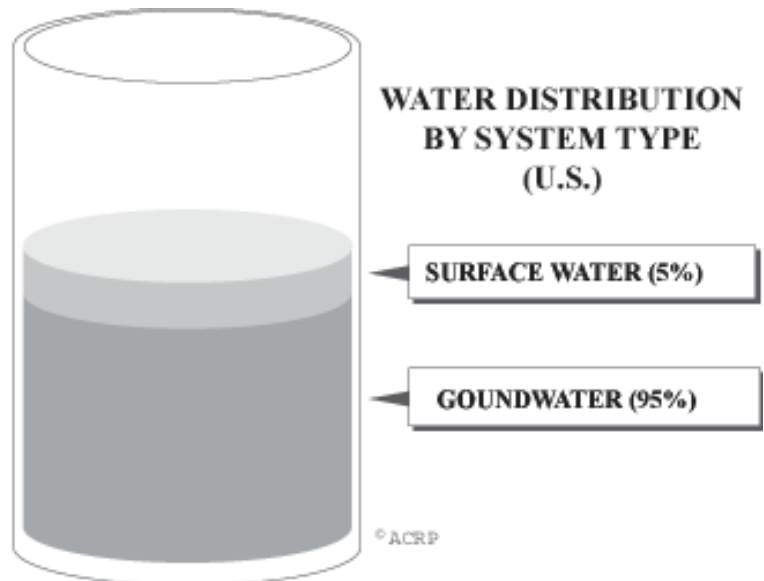

Figure 3.6 - Water Distribution by System

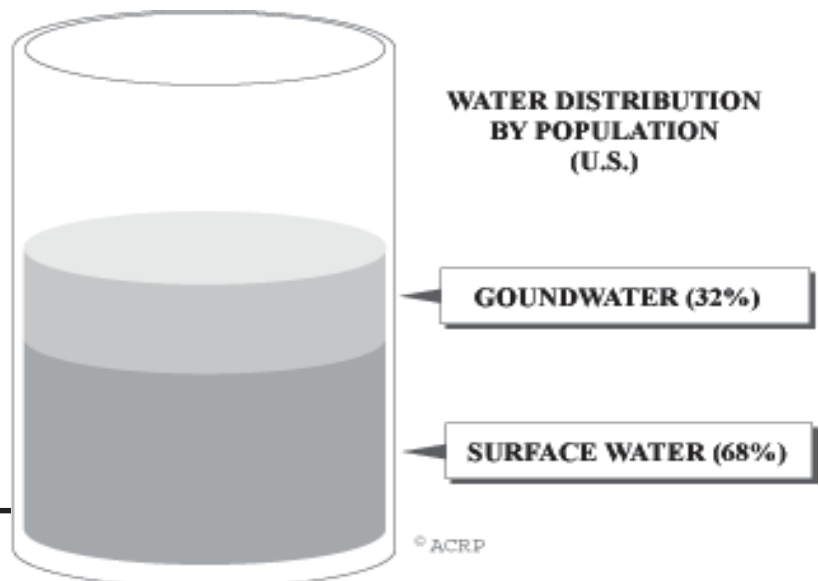

Figure 3.7 - Water Distribution by Population (U.S.)

### References

ACR Publications, Inc., Skeet Arasmith, *Introduction to Small Water Systems*, Chapter 1

### BASIC & ADVANCED STUDY QUESTIONS

1. Water is called the \_\_\_\_\_ solvent.
2. What are the two sources of water?
3. What is the word used to identify water that is safe to drink?
4. Water cycles from the atmosphere to the earth and back to the atmosphere. What is this natural water cycle called?
5. As a part of the normal water cycle water is lost, or given up, to the atmosphere by trees and by evaporation from the surface of streams, lakes, and oceans. This combined loss is called \_\_\_\_\_.

# CHAPTER 4: WATER SAMPLING

## NEW MEXICO WATER CONSERVATION FEE

The NM Water Conservation Fee of 3 cents per 100 gallons is collected from each public water system in order to fund sample collection and testing for inorganic, organic, and radiological contaminants. The fee also covers bacteriological testing. This means that most water systems are only responsible for collection of monthly bacteriological (microbiological) samples in order to comply with SDWA monitoring schedules.

## WATERBORNE PATHOGENS

Water systems must strive to keep their drinking water free of pathogens (disease causing bacteria). They can be transported either by water or physical contact. People that have contracted these diseases are called carriers. Without proper medical attention and treatment, individuals can still transmit the disease even though they no longer have any of the symptoms. There are five waterborne pathogens that can be found in all water supplies and two that are only found in surface water supplies. The bacteria that are found only in surface water supplies form cysts and spores that protect them from cold temperatures. Because of this protection, they are much more difficult to kill with disinfectant chemicals.

### WATERBORNE DISEASES

#### All Water Supplies:

- Typhoid
- Paratyphoid (Types A & B)
- Cholera
- Dysentery
- Hepatitis

#### Surface Water Only:

- Cryptosporidium
- Giardia

All of these diseases are caused by pathogenic bacteria except hepatitis, which is a virus. It is very difficult to identify any one particular pathogen by laboratory testing. To make testing more reliable and economical, the lab tests are designed to identify a large family of bacteria that are related to the disease causing bacteria, rather than identifying each type of pathogen.



**Figure 4.1 - Waterborne Diseases**

Reprinted, with permission, from *Operation of Wastewater Treatment Plants*, Vol. I, 2<sup>nd</sup> ed., Office of Water Programs, California State University, Sacramento Foundation

## COLIFORM GROUP OF BACTERIA

Coliform bacteria are enteric bacteria. This means that they are found in the intestinal tract of warm-blooded animals, including humans. These bacteria, known as E. Coli in humans, do not cause disease but are necessary for the digestion of food. The waterborne pathogens are also enteric bacteria and are part of the coliform family. Therefore, if coliform bacteria are present in the water supply, pathogens may also be present. The coliform bacteria live longer in water and are easier to detect by laboratory testing. This is the reason the coliform group has been chosen as the indicator organism for waterborne pathogens. If coliform bacteria are not present it is assumed there are no pathogens present.

The coliform family has been divided into two groups. Results may come back as total coliform positive or fecal coliform positive. Total coliform positive means that no human coliform are present. Fecal coliform positive indicates the presence of E. Coli, which means there is a greater chance of pathogens being present. The laboratory tests for coliform include the MPN method, the Membrane Filter test, and the Colilert test.

## SAMPLING SCHEDULES AND TECHNIQUES

It is the responsibility of the system to collect samples for bacteriological (“Bac T”) testing. It is very important to make sure samples are collected, tested and reported properly. If a sample becomes contaminated due to poor sampling procedures, or is not sent to the testing facility at the proper time, the system may technically be in violation of SDWA standards. This may result in the system having to notify the public of violations when the water is actually safe.

### SAMPLING SCHEDULES

The federal regulations regarding “Bac T” sampling schedules set the minimum number of samples a water system must submit at one per month. As the size of the system increases so does the minimum number of samples required each month. These sample results, and any necessary re-takes, must be reported to the NMED by the end of each calendar month.

The sampling points should be identified by a sampling plan that samples are taken from all major parts of the system to assure that the entire system is represented. Small systems must have at least two sample sites in the system. One point where water enters the distribution system and another at a customer’s faucet. Samples should also be taken at regular intervals during the month. Even the best sampling plan can only indicate that the system was safe at the time it was sampled and only at the sites where samples were taken.

## SAMPLING TECHNIQUES

The first consideration in collecting a “Bac T” sample is the sample bottle. These bottles are provided by the New Mexico Environment Department. They are sterilized prior to being sent to the systems. They should be stored in a cool, dry place until they are needed for a sample. Sodium thiosulphate is added to the bottle before it is sterilized. Its presence may be indicated by a trace of white powder in the bottom of the bottle. The purpose of the sodium thiosulphate is to neutralize any chlorine that may kill any bacteria that are in the sample.

Two things to remember when using sample bottles:

1. Never wash out a bottle or even open it until you are ready to take the sample.
2. If a sample bottle has any dirt or junk in it or in the lid, don't use it. It's better to get a new bottle than to take a bad sample.

Once the pre-sterilized bottles are obtained, the next consideration is the actual collection of the sample. The procedure for collecting the sample is given below. These instructions should be carefully followed to prevent accidental contamination of the sample.

1. **Select a sampling point.** Always keep sanitary conditions in mind when selecting a sampling point. Never use a kitchen sink faucet or an outdoor faucet that drips. Any hoses, vacuum breakers or other attachments must also be removed. The rule of thumb is to select a faucet that is used the least.
2. **Flush the line.** Open the tap and let the water run for several minutes. This will insure that the water being sampled is from the main and not from the customer's plumbing.
3. **Collect the sample.** Remove the cap, making sure that you do not touch the inside of the cap or the top of the sample bottle. Don't aerate the sample or allow it to splash on the outside of the bottle. Fill the bottle carefully to the shoulder of the bottle. This guarantees that there is at least 100ml of sample in the bottle. Do not fill it all the way. An air bubble is needed to stir the sample before it is tested at the lab. Never set the cap down or leave it off longer than it takes to collect the sample. Mark the bottles for identification. The samples should then be placed under refrigeration until tested.

## REPORTING AND SHIPPING CONSIDERATIONS

The final consideration for “Bac T” sampling is the proper completion of the sample form. Make sure the following items are listed on the sample form:

---

**Table 4.1 - BAC-T Sample Form**

1. **System name, address, and identification number**
  2. **Location of sampling site**
  3. **Date and time sample was taken**
  4. **Type of water sampled (raw or treated)**
  5. **Chlorine residual**
  6. **Computer ID number**
  7. **Name of operator taking sample**
- 

There are times when water systems need to collect Bac-T samples for reasons other than monitoring compliance. New water lines and lines that have been repaired should be tested. Wells that have been disinfected should be tested. These samples must be identified as something other than a compliance sample so they will not count as a violation against the system if they are found to be positive. This is done by checking “Special Sample” on the form and identifying the type of sample in the “Remarks” line.

There are certain requirements regarding the age of a Bac-T sample. New Mexico Drinking Water Regulations state that the sample must be tested within thirty hours after it is taken. If a sample does not arrive at the lab within this time period it will not be tested. To help avoid this, make sure all samples are sent in on time, preferably at the first of the week. Always obtain a receipt from the postmaster as part of the chain of custody.

## RETAKES AND VIOLATIONS

Anytime a Bac-T sample result comes back positive, indicating the presence of coliform, retake samples must be taken. Three retakes are usually required. One must be taken at the site of the positive sample. The other retakes are upstream and downstream of the site (within five service connections.) These retakes must be taken within 24 hours of receipt of positive results. They must be identified as “Resample” on the sample form. When retakes are needed, a minimum of five samples will be required for the following month.

When retakes come back positive, the system is usually in violation of the SDWA standards (unless 40 or more samples are taken then 5% of the samples can be positive.) If all of the positive samples were total coliform, it is a non-acute violation. If fecal coliform positives occur in either the original or the retakes, it becomes an acute violation with immediate

notification. In either case the NMED must be notified within 24 hours of any positive sample results. The Water system is responsible for any public notification that may be required.

4. How soon must NMED be notified that a bacterial MCL has been exceeded?

---

### References

Office of Water Programs, California State University, Sacramento, *Water Treatment Plant Operations, 4<sup>th</sup> ed. 1999, Volume 2, Chapter 22.*

*Safe Drinking Water Act*

*NMED Drinking Water Regulations*

---

### BASIC STUDY QUESTIONS

1. What is an indicator organism?
2. What is sodium thiosulphate?
3. Why should you flush before sampling?

### BASIC SAMPLE TEST QUESTIONS

1. Which of the following is an indicator organism?
  - A. Giardia
  - B. Cryptosporidium
  - C. Hepatitis
  - D. E. Coli
2. Which factor is used to determine how many Bac-T samples must be taken?
  - A. Number of operators
  - B. Type of treatment
  - C. Number of people served
  - D. Amount of water produced
3. What is the minimum number of Bac-t sample(s) required each month?
  - A. 1
  - B. 2
  - C. 3
  - D. 4

### ADVANCED STUDY QUESTIONS

1. How many retakes are required for each positive?
2. Which bacteria are found only in surface water supplies?
3. What must be done on the sample form to identify a Bac-T sample is from a well and is not a compliance sample?

### ADVANCED SAMPLE TEST QUESTIONS

1. How many samples must be taken before two positive results DO NOT result in an MCL violation?
  - A. 10
  - B. 20
  - C. 40
  - D. 80
2. A sample must be tested within how many hours?
  - A. 24
  - B. 30
  - C. 48
  - D. 60
3. Anytime the MCL is exceeded and fecal coliform positive results came back from any of the samples...
  - A. This is an acute violation
  - B. This is a non-acute violation
  - C. There is no notification required
  - D. Only written notification is required
4. If retakes are required this month, what is the minimum number of samples required next month?
  - A. 5
  - B. 10
  - C. 15
  - D. 20

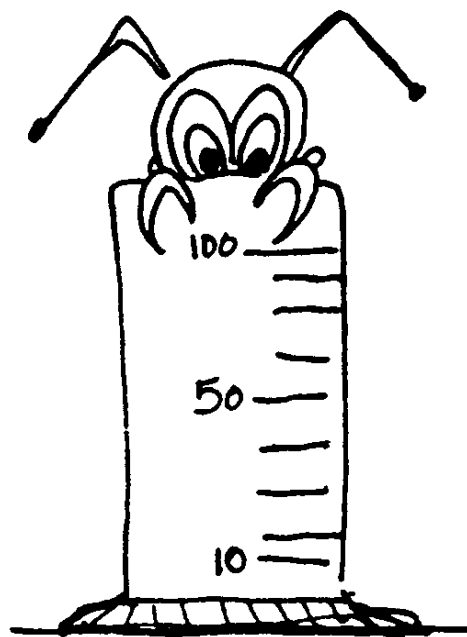

BLANK PAGE

# CHAPTER 5: DISINFECTION

---

## TYPES OF DISINFECTION

The process of killing pathogenic bacteria in the drinking water supply is known as disinfection. Disinfection is the final step in the treatment process and is necessary to provide a “bacteriologically safe” drinking water for the public. Disinfection is now required for all public water supplies. Chlorination is the most common means of killing disease-causing bacteria in water supplies.

While chlorine is used primarily for disinfection in water treatment, it also has other uses in the treatment process. Chlorine can be used to remove iron and manganese, some kinds of tastes and odors, and some dissolved gases, such as Ammonia ( $\text{NH}_3$ ) and Hydrogen sulfide ( $\text{H}_2\text{S}$ ). The use of chlorine in these instances usually occurs early in the treatment process. Pre-treatment of raw water by pre-chlorinating used to be a fairly common practice until the mid-1970's. Concerns over disinfection by-products, such as TriHaloMethanes (THM's) and halo acetic acids, have almost eliminated the practice of pre-chlorination in the United States. The removal of taste and odors from raw water is now accomplished using Powdered Activated Carbon (PAC) or oxidizing agents other than chlorine, that do not result in chlorinated by-products. The growing concern regarding the use of chlorine as a disinfectant may eventually mean a change to one of these other oxidizing agents as the primary means of disinfection at sometime in the future.

## CHLORINATION

Chlorine is the most widely used disinfectant because it is readily available, easily applied, and cheaper than other oxidizing agents such as potassium permanganate ( $\text{KMnO}_4$ ), chlorine dioxide ( $\text{ClO}_2$ ), UV disinfection, or ozone ( $\text{O}_3$ ). Chlorine is applied in one of three forms; chlorine gas, chlorine powder (HTH), or an aqueous solution like chlorine bleach.

## CHLORINE GAS

Chlorine gas ( $\text{Cl}_2$ ) is compressed into a liquid for storage. It can be purchased in cylinders containing 150 or 2000 pounds of the liquefied gas. Chlorine gas is cheaper per pound than either of the other forms.

## CHLORINE POWDER

Chlorine in its dry form is calcium hypochlorite [ $\text{Ca}(\text{OCl})_2$ ]. It is also most commonly known by the trade name HTH (High Test Hypochlorite). Only about 65 – 70% of the HTH is available as chlorine. The rest is calcium, which is not a

disinfectant. Dry chlorine is 2-3 times more expensive, per pound of chlorine, than chlorine gas.

## CHLORINE BLEACH

Chlorine bleach is a liquid solution of sodium hypochlorite ( $\text{NaOCl}$ ). Bleach is usually 3 – 12% available chlorine and 88 – 97% water. Bleach is the most expensive form of chlorine and is normally used for disinfecting small wells and water lines. It is sometimes used for supply disinfection in very small water systems.

## CHLORINE TREATMENT TERMS

Several terms are used to identify the various stages and reactions that occur when chlorine is used as a disinfectant. The basic unit of measurement for chlorination, or any other chemical treatment is milligrams per liter (mg/l) or parts per million (ppm). These are very small units reflecting concentrations that are essentially on art chemical for every million parts of water. To get some idea of how small a concentration this really is it should be pointed out that 1% is equal to 10,000 mg/l or ppm.

## CHLORINE DOSAGE

The chlorine dosage is the amount of chlorine that is added to the water. The dosage can be determined from the number of pounds of chlorine used and the number of millions of pounds of water treated.

## CHLORINE DEMAND

Chlorine is a very reactive oxidizing agent. It will react with a certain substances that may be found in water. This list includes; iron, manganese, hydrogen sulfide, organic compounds and ammonia. When chlorine reacts with these substances, it loses its disinfecting properties. This is referred to as the chlorine demand. For chlorine to be effective as a disinfectant, the dosage must always exceed the demand that is present in the water. The chlorine demand may vary from day to day in a surface water supply. It is usually fairly constant in a ground water supply.

## CHLORINE RESIDUAL

The chlorine that remains in the water, after it has finished reacting with those substances that represent the demand, is known as the chlorine residual. The concentration of the residual determined by subtracting the demand from the dosage.

*EXAMPLE:* A 4.0 mg/l dosage is added to water that has a demand of 2.5 mg/l.  
What is the residual?

$$\begin{aligned} \text{Dosage} - \text{Demand} &= \text{Residual} \\ \text{or} \\ 4.0 \text{ mg/l} - 2.5 \text{ mg/l} &= 1.5 \text{ mg/l Residual} \end{aligned}$$

There are two types of residuals that result from the chlorination of water. They are free chlorine residual and combined chlorine residual.

#### Free Chlorine Residual

After the demand has been satisfied, any chlorine that is left will react with water to form hydrochloric acid and hypochlorous acid.

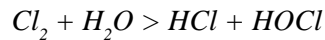

The hypochlorous acid is the disinfecting agent and the presence of the hypochlorous ion ( $\text{OCl}^-$ ) is measured to obtain the free chlorine residual.

#### Combined Chlorine Residual

Chlorine reacts with water to form hypochlorous acid. If ammonia is present, the hypochlorous acid will react with it to form compounds known as chloramines.

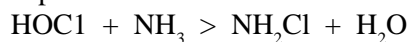

Chloramines are found in three forms. They may contain from one ( $\text{NH}_2\text{Cl}$ ) up to three ( $\text{NCl}_3$ ) atoms of chlorine. The chemistry of the water and concentration of chlorine will dictate which of the chloramines are formed. Chloramines are weak disinfectants. They require longer contact times and higher concentrations to achieve disinfection than free chlorine residual. However, they do not breakdown as quickly as free chlorine and remain in the system longer.

### **DISINFECTION REQUIREMENTS**

Two factors must be taken into consideration when disinfecting drinking water. First, enough chlorine must be added to reach a predetermined concentration in the water. Then the bacteria must come in contact with the solution for a certain period of time. This is referred to as achieving the proper residual and contact time. Killing pathogenic bacteria requires a minimum of 0.2-0.4 milligrams per liter (mg/l) of free chlorine residual and a contact time of 20 minutes. The contact time can be reduced if the residual is increased. Viruses, Giardia, and Cryptosporidium are harder to destroy than the other waterborne diseases. Free residuals of 1.5-2.0 mg/l and much longer contact times may be required to destroy these organisms.

### **EFFECTS OF TEMPERATURE AND pH**

Changes in temperature and pH of the water can reduce the effectiveness of chlorine. Colder temperatures slow

down reaction times requiring higher concentrations and longer contact times to achieve proper disinfection. A high pH impedes the formation of the hypochlorous acid and requires a higher dosage to obtain the proper residual.

### **BREAKPOINT CHLORINATION**

When chlorine is added to water that contains no ammonia, the residual that is obtained will be free available chlorine. If ammonia is present, and the demand has been satisfied, some of the free chlorine will react with the ammonia to form chloramines or combined chlorine residual. As more chlorine is added, it will breakdown the chloramines that have been formed and the combined residual will begin to drop. A point will be reached where the residual will begin to rise again after all of the chloramines, that can be, are destroyed. There may be some combined residual left in the water at this point. From this point, any additional chlorine dosage will result in the formation of only free chlorine residual. This is known as the "breakpoint". All water systems that chlorinate their water will, in fact, practice breakpoint chlorination. They will add enough chlorine to the water to achieve a free chlorine residual of at least 0.2-0.5 mg/l.

The Breakpoint Curve shown below illustrates the formation and destruction of chloramines before free residuals are achieved. Every system's breakpoint will vary depending on the chemical makeup and chlorine demand of the raw water.

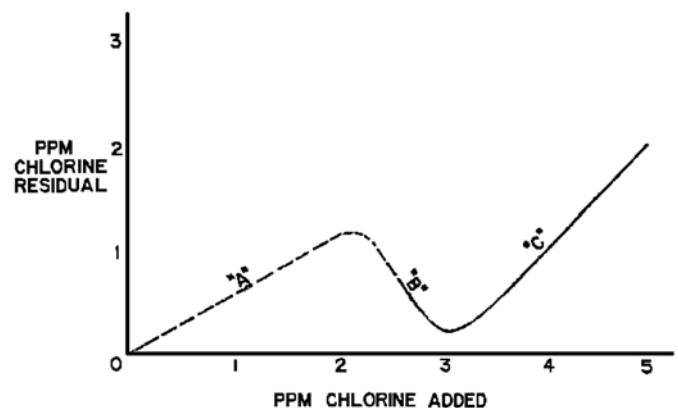

**Figure 5.1 - Breakpoint Curve**

As chlorine is added to the water, it reacts with the ammonia that is present and a combined residual reading is obtained.

Tracking the Breakpoint Curve illustrated in Figure 5.1:

- "A" - In this case, as the dosage increases to about 2ppm (mg/l) the combined residual drops because the chloramines are being destroyed.



- “B” - When the dosage reaches 3ppm (mg/l), the breakpoint occurs and first free chlorine residual is obtained. Once the breakpoint has been reached, the free residual will increase at the same rate as the dosage.
- “C” - There may still be some combined residual in the water even though the breakpoint has been reached, but it will remain at this minimum level as long as the dosage is greater than 3 ppm (mg/l).

A common complaint received by many operators is that the water has a “chlorine odor.” These odors are almost always caused by chloramines in the water rather than a free chlorine residual. Understanding the break point curve may help solve this problem.

The initial reaction to this type of call may be to reduce the chlorine dosage to reduce the odors. This is actually the last thing that you would want to do. First, the problem may be remedied by simply flushing the line in the area of the complaint. The odors are usually a result of stale water sitting in the lines. The free chlorine that was originally present may have broken back down into chloramines. Flushing will remove the stale water and the odor problem, until the water gets stale again. If flushing doesn’t correct the problem, look at the breakpoint curve before adjusting the chlorine feed rate.

If the current conditions place us on the left side of the breakpoint there is no free residual present. This can be confirmed with a residual test. That means the water is on the “B” portion of the curve. Decreasing the chlorine dosage will result in moving further to the left on the curve into the “A” portion. Here the chloramine concentration is even higher and the odors may become worse instead of better. If the dosage is increased to the point where free chlorine residuals are present again, the amount of chloramines (and their odors) will be kept to a minimum.

### TESTING FOR CHLORINE RESIDUALS

There are three methods that are used to test water for chlorine residual. Two of them are field tests. The Ortho-Tolidine-Arsenite (OTA) test was the industry standard until the mid-1970’s. The problem with the OTA test was that iron and nitrites in the water would interfere with the test. In addition, OTA was found to be a carcinogen. It is no longer used for chlorine residual testing today. Instead, the Diethyl-p-Phenylene-Diimine (DPD) test is used for field work. It is similar to OTA test but is not known as the amperometric titration method. It is normally run in a laboratory.

The DPD test is a colorimetric analysis. The reagent is added to a vial of sample water. Another vial of sample water serves as a “blank.” If chlorine is present the sample will turn pink or

red. The blank is placed in front of the “color wheel” and the sample is compared to the color wheel and blank. There are two chemical packets for the DPD test. One is used for free chlorine and the other is used for total chlorine residual. Subtracting the free residual from the total residual will give you the combined residual.

### GENERAL CHLORINE SAFETY

Chlorine is a greenish-yellow gas. It is 2.5 times heavier than air. Chlorine gas is very corrosive. It turns into hydrochloric acid when it comes in contact with moisture (in the water, in the chlorine lines, or in your eyes or lungs). It does not support combustion. It can be harmful if inhaled in small quantities and fatal in larger doses. The following

**Table 5.1 - Chlorine Symptoms**

SYMPTOM	CONCENTRATION
Noticeable odor	0.2 ppm
Irritation after several hours	1.0 ppm
Irritation of throat after a few minutes	15 ppm
Immediate coughing	30 ppm
Dangerous after 30 minute exposure	50 ppm
Lethal in minutes	1000 ppm

table lists the effects of chlorine gas in various concentrations in the atmosphere. Because of the potential for injury to workers and the general public from chlorine gas accidents, safety must always be the first consideration when handling chlorine.

### CHLORINATOR ROOM

The chlorinator room should have a window in the door so that the operator in the room can be seen from the outside. The light and vent switches should also be located outside the room. The room should have ventilation located at floor level since chlorine gas is heavier than air and will settle in the lowest spot in the room.

The room should be kept between 60°F and 120°F. Below 60°F, chlorine gas forms chlorine hydrate, also known as “green ice,” when it comes in contact with water. This green ice can clog the injector and gas piping, creating a serious maintenance problem.

When a chlorine cylinder is full and at room temperature, it is about 85% full of liquefied chlorine. As the temperature

rises, the liquid expands and takes up more space in the cylinder. At 157° F the liquid will expand to occupy 100% of the cylinder. If the liquid expands any further the cylinder will rupture, causing a massive chlorine leak.

NEVER enter a chlorine facility without ventilating for several minutes first. The National Fire Code now requires that new gas chlorine facilities be equipped with a scrubber system that will remove chlorine gas that may be present in the ventilation exhaust. These systems must have a backup power supply to keep the scrubber running in the event of a power failure. Check with local Fire authorities before new chlorine facilities are built to make sure they will be in compliance.

### CHLORINE STORAGE

The room where chlorine cylinders or HTH drums are stored must be kept dry and well ventilated. Chlorine should always be stored in a room separate from other chemicals. Chlorine cylinders that are empty should be separated from those that are full. When not in use, all cylinders should be chained to the wall.

### CHLORINE CYLINDERS

NEVER remove the valve hood from a chlorine cylinder unless it is chained to the scales and ready to be put on the system. All cylinders should be chained to the wall or the scales unless they are being moved. Emergency repair kits are available that can be used to seal leaks in the broken valves or leaking cylinders. Every system that operates a gas chlorine system should have an emergency kit or be able to get access to one on very short notice.

To prevent the cylinder from rupturing when it gets too hot, every gas cylinder will have a “fusible plug” that is designed to melt at 157° F. There is one in the valve assembly of

every 150 lb. Cylinder and six (three on each end) in the body of very 1-ton cylinder. As one of these fusible plugs melts, it will allow the release of chlorine gas from the cylinder. This still represents a serious problem, but the release will be more gradual than it would if the tank ruptured.

### HTH HANDLING SAFETY

Powdered chlorine should be stored in a cool dry place separate from other chemicals. HTH must never be allowed to come in contact with petroleum products or organic solvents. If this happens, it will explode violently! This is also true for the other forms of chlorine, but is more likely to occur during the handling of HTH. Care must also be taken to avoid contact with the eyes or bare skin.

### RESPIRATORY PROTECTION

Anyone involved in handling chlorine should have access to respiratory protection equipment. Chlorine gas forms hydrochloric acid when it gets in the eyes or lungs. This can result in serious injury or death depending on the concentration and exposure time. The damage caused by exposure to chlorine gas is cumulative. Several incidents involving minor exposure can contribute to serious health problems at sometime in the future.

There are two basic types of respiratory protection. One is the gas mask that uses a filtering device to remove chlorine. These are either a full-face mask or a mouth/nose type respirator. The other type of respirator is the self-contained breathing apparatus (SCBA). The SCBA unit is full-face mask with an air tank to provide the operator with fresh air to breathe when in hazardous atmospheres. Both of these devices may be rendered ineffective if the wearer has facial hair that interferes with the face-to-mask seal.

### Gas Masks

The gas mask is designed to allow the operator time to escape the chlorine room when a leak occurs. THESE DEVICES ARE INTENDED FOR ESCAPE PURPOSES ONLY! A GAS CANISTER MASK MUST NEVER BE USED TO ENTER ANY AREA WHERE CHLORINE GAS IS PRESENT! If the release of chlorine drops the oxygen concentration below 12%, it is impossible to survive even if all the chlorine is filtered out. If an operator is wearing a canister mask he must still leave the area immediately upon detection of a chlorine leak. The gas canisters should be changed every six months or anytime it has been exposed to chlorine gas.

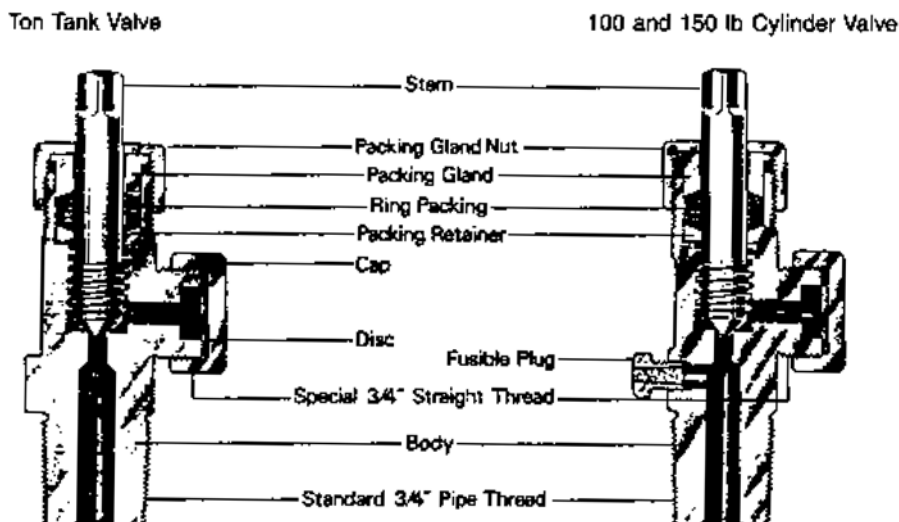

Figure 5.2 - Chlorine Cylinder Valve

### Self-Contained Breathing Apparatus (SCBA)

The SCBA unit must be used when working in a chlorine gas atmosphere. It has an air tank that allows the wearer to breathe uncontaminated air while attempting to correct a chlorine leak situation. The SCBA tank will hold enough air for approximately 30 minutes, depending on working conditions. When the air pressure drops to a point where there is about five minutes of air remaining in the tank (500 psi), an alarm will ring to signal the operator that it is time to exit the area and change tanks.

### CHLORINATION EQUIPMENT

There are two ways to feed chlorine into the water system. Gas chlorination uses liquefied chlorine gas. Hypochlorination uses a positive displacement pump to feed a solution of dissolved HTH or bleach into the system. Many smaller systems will use a hypochlorination system because the equipment cost is lower. The solution of dissolved HTH or bleach is much easier to handle and presents less of a risk compared to a gas system. Gas chlorinating is used where the system requires larger dosages of chlorine than can be delivered by hypochlorination. Though capital costs are higher for gas chlorination, the chemical costs are significantly lower than when HTH or bleach is used.

rate indicator, a flow regulating device (a V-notch plug or needle valve), and an injector or ejector. The chlorine pressure regulating valve (CPRV) opens when a vacuum is created by the injector and maintains a constant negative pressure inside the chlorinator. The feed rate indicator consists of a ball floating inside a glass tube. The feed rate is indicated on the glass tube and is read in “pounds per day.” The feed rate should be read at the widest point of the ball or bead. The feed rate is controlled using the needle valve or V-notch plug. Water flowing past the injector creates a vacuum that draws the gas into the system.

The maximum feed rate for gas drawn from a 150 lb. Cylinder is 40 pounds/day. The maximum gas feed rate for a 1-ton cylinder is 400 pounds/day. If these feed rates are exceeded, the tanks will frost over because heat can't pass through the tanks as fast as it is used to evaporate the chlorine from a liquid to a gas. This can also occur in situations where several tanks are manifolded to the chlorinator. If one of the cylinder valves is partially closed the other tanks may try to feed too

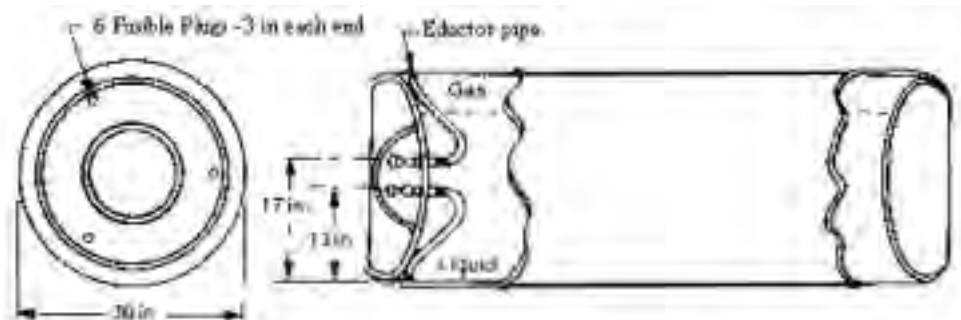

Figure 5.4 - Cross Section of a 1-ton Cylinder

### GAS CHLORINATION

A gas chlorine system consists of one or more gas cylinders connected to gas chlorinator. The gas chlorinator consists of a pressure regulating valve, a feed

much gas and frost over. When this happens, check the tank that isn't frosted for a closed valve or plugged pigtail line. Ton

cylinders are sometimes set up to feed liquefied gas. These systems use an evaporator to change the liquid to a gas before it goes to the chlorinator. There is no limit to how much liquid chlorine can be removed from a cylinder since the heat for evaporation is supplied by an outside source. NEVER manifold cylinders together when feeding liquefied chlorine to an evaporator. Expansion tanks equipped with rupture disks are used to protect all liquid feed piping. These provide protection from expansion of liquefied gas that may become isolated in the line.

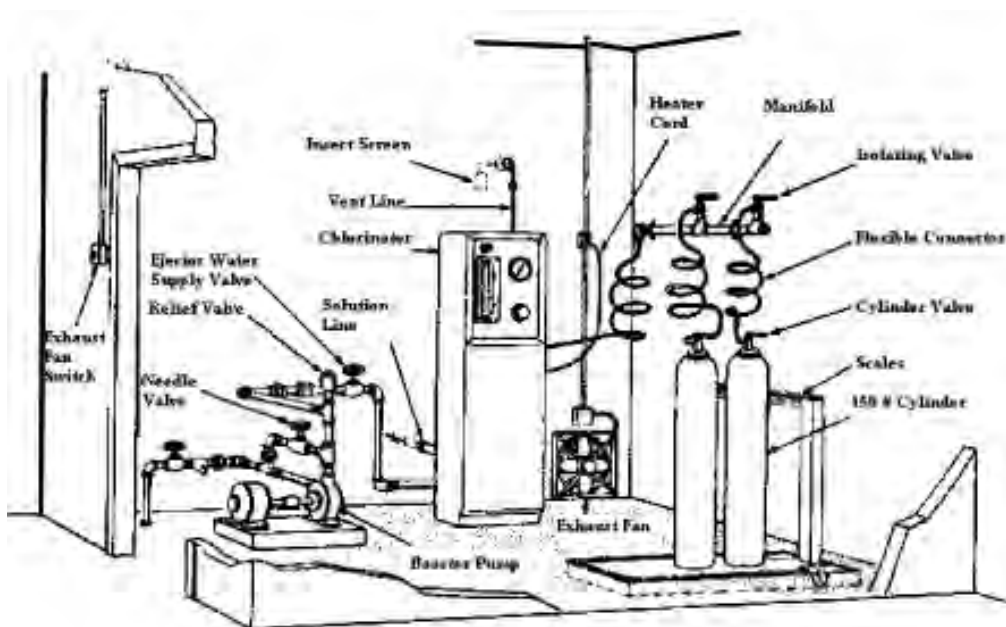

Figure 5.3 - Gas Chlorine Installation (150 Lb. Cylinders)

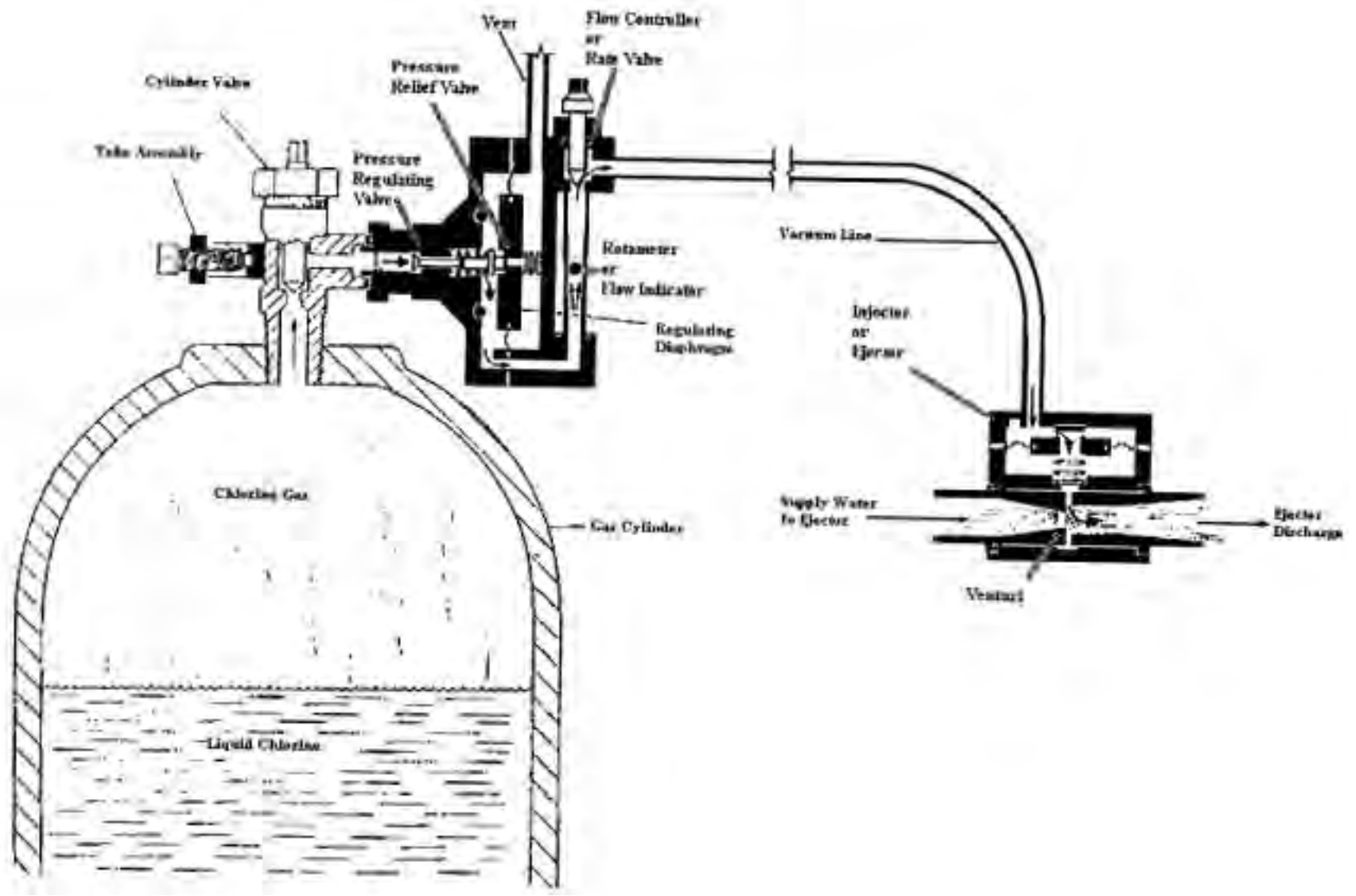

Figure 5.5 - 150 lb Chlorine Gas Feed Unit

## HYPOCHLORINATION SYSTEMS

A typical hypochlorination system will consist of:

may need to dilute the solution further, since the low flows may require feed rates too low for most feed pumps. Dilution of 5.25% bleach may be easier than HTH solutions.

**Table 5.2 - Troubleshooting Gas Chlorinators**

Symptom	Probable Cause
Low Feed Rate and Low Vacuum	Clogged Injector/Ejector
Low Feed Rate and High Vacuum	Clogged Gas Feed Line Closed Cylinder Valve Empty Cylinder
Feed Rate Jumps	Clogged Flow Controller/Needle Valve
Feed Rate Won't "Zero"	Dirty Flow Indicator/Rotameter
Chlorine Gas at Vent	Dirty Pressure Regulating Valve
No Vacuum	No Supply Water Vacuum Leak

The chemical feed pump consists of a diaphragm driven pump chamber, and two check valves. The check valves, that provide the one-way flow through the pump, can get clogged with lime deposits. This occurs because the HTH that is added to the solution tank is 30-35% lime. The strainer on the pump suction line should be located several inches above the bottom of the solution tank to prevent lime and grit from being drawn into the pump and fouling the check valves.

If the check valves get fouled, the pump will not pump any solution. Flushing the line with

- A solution tank holding bleach or an HTH solution.
- A chemical feed pump, usually a diaphragm-type pump.
- A tee into the well line as the point of application.

clean water or a weak acid, like vinegar, may also correct the problem. In severe cases the valves may have to be disassembled and cleaned. Always make sure the pump is primed before putting it back into service. It may also be advantageous to locate the pump so that it has a positive suction head.

The solution tank should hold at least a one-day supply of chlorine solution. If the solution is bleach, it will have between 5.25% and 12% available chlorine (1/3 to 1 lb./gallon respectively). If HTH is used, add 1.5 pounds of HTH per gallon of water to achieve a 1.0-lb./gallon chlorine solution. Using breakpoint chlorination, adjust the stroke on the pump to achieve the desired dosage. Small systems

## EMERGENCY RESPONSE PROCEDURES

When chlorine systems are located in areas where a chlorine release might endanger the general public, the water system is responsible for developing an emergency response program.

The following steps should be followed when a leak poses immediate danger to employees or the public:

1. Evacuate, in an upwind direction, to high ground.
2. Once evacuation is complete, notify emergency medical units of casualties and begin administering First Aid to the injured.
3. Notify local fire and police departments. Include the following information:
  - a. Nature of the accident
  - b. Approximate amount of chlorine that may be released

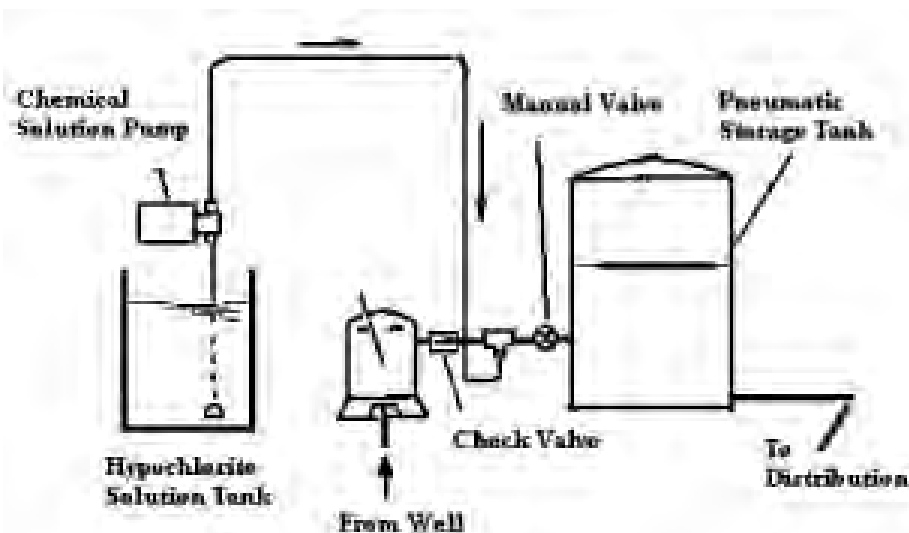

**Figure 5.6 - Typical Hypochlorination System**

- c. Location of chlorine facility
  - d. Current wind direction
4. Notify County and State health agencies.

## ULTRAVIOLET LIGHT

### BACKGROUND

One of the numerous forms of energy is electromagnetic. Electromagnetic energy travels in wave forms and is found in a wide range of frequencies all the way from radio waves to X-rays and includes visible light. Electromagnetic energy is divided into bands based on frequency. One of these bands is the ultraviolet band. This is a band of light that ranges from 200 to 390 nm (nanometers). Bacteria, when exposed to electromagnetic energy at approximately 260 nm are prevented from multiplying and thus die off. A mercury vapor light will produce an ultraviolet wave at 254 nm and has been found to be very effective in the destruction of bacteria and viruses.

### NOT EFFECTIVE WITH GIARDIA

Ultraviolet has not been found to be effective in the destruction of *Giardia* cyst because it cannot penetrate the hard wall of the cyst.

### USING ULTRAVIOLET LIGHT

Ultraviolet light is not selective. That is, it will kill all bacteria in its path, providing that the water is clean (less than 15 ntu), free of color, the water depth is no more than three inches and an appropriate amount of energy is applied. UV leaves no residual, thus requiring the addition of chlorine or some other disinfectant in order to maintain a residual in the system. Typically, in drinking water systems, UV is more expensive than chlorine.

### UV EQUIPMENT

A UV device is fairly simple, it is a stainless steel cylinder, housing a mercury vapor light. Water is passed through the cylinder and thus exposed to the light. Slime can build up on the tube and reduce the effectiveness of the device. Many of these devices have wipers for removing the slime.

Table 5.3 - Components of an Emergency Response Plan	
COMPONENTS OF AN EMERGENCY RESPONSE PLAN	
*	Containment and repair of the leak
*	Notification of other emergency preparedness agencies
*	Evacuation plans for the general public
*	Medical evacuation for casualties

### References

- Office of Water Programs, California State University, Sacramento, *Water Treatment Plant Operation*, Volume 1, 4<sup>th</sup> ed., Chapter 7
- Office of Water Programs, California State University, Sacramento, *Water Distribution System O&M*, 4<sup>th</sup> ed., Chapter 6.
- Office of Water Programs, California State University, Sacramento, *Small Water System O&M*, 4<sup>th</sup> ed., Chapter 5
- ACR Publications, Inc., Skeet Arasmith, *Introduction to Small Water Systems*, Chapter 4

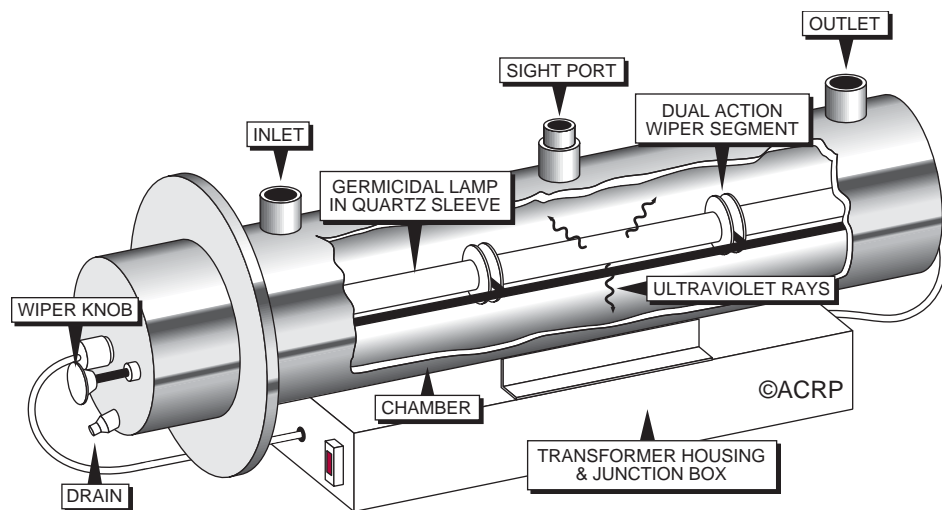

Figure 5.7 - UV Disinfection System

## BASIC STUDY QUESTIONS

1. What is meant by disinfection?
2. What are some of the uses for chlorine other than disinfection?
3. What is a free chlorine residual?
4. What are trihalomethanes?

## BASIC SAMPLE TEST QUESTIONS

1. Locate chlorine leaks with:
  - A. Bleach
  - B. Ammonia
  - C. Hydrochloric acid
  - D. Water
2. Chlorine gas is 2.5 times heavier than air.
  - A. True
  - B. False
3. Chloramines are:
  - A. Formed when chlorine reacts with ammonia.
  - B. Weaker disinfectants than free chlorine.
  - C. Responsible for most chlorine odor complaints.
  - D. All of the above
4. If a single chlorine cylinder freezes, what is wrong?
  - A. Valve is too far open
  - B. Vacuum is too high
  - C. Feed Rate is too high
5. Sodium Hypochlorite is what found in which type of chlorine?
  - A. Bleach
  - B. HTH
  - C. Gas

## ADVANCED STUDY QUESTIONS

1. What two acids are formed when chlorine reacts with water?
2. Why should chlorine rooms be kept below 120°F?
3. What is the maximum gas feed rate for a 150 lb. Cylinder?
4. How should you handle chlorine odor complaints?
5. What additional pieces of equipment will be needed to feed liquefied chlorine gas from a ton cylinder?

## ADVANCED SAMPLE TEST QUESTIONS

1. Breakpoint chlorination
  - A. Results in a free chlorine residual
  - B. Occurs when a 0.5 ppm dosage increase raises the free residual by 0.5 ppm
  - C. Very seldom causes chlorine odor complaints
  - D. All of the above
2. Chloramines
  - A. Are a weak disinfectant.
  - B. Are formed when chlorine reacts with ammonia.
  - C. Are usually responsible for most chlorine odor complaints.
  - D. All of the above.
3. If gas is venting from the relief valve on a chlorinator where should you look for the problem?
  - A. The injector
  - B. The rate of flow control valve
  - C. The rotameter
  - D. The pressure regulating valve
4. When two ton cylinders are feeding gas and one of them is frosted, what might be the problem?
  - A. The feed rate is too high
  - B. The line on the frosted tank is clogged
  - C. The valve on the unfrosted tank
  - D. The injector is clogged
5. There is low vacuum on the system and the flow rate is low when the rate valve is wide open, what is the problem?
  - A. The feed rate is too high
  - B. The injector is clogged
  - C. There is a clogged feed line
  - D. The rotameter is clogged

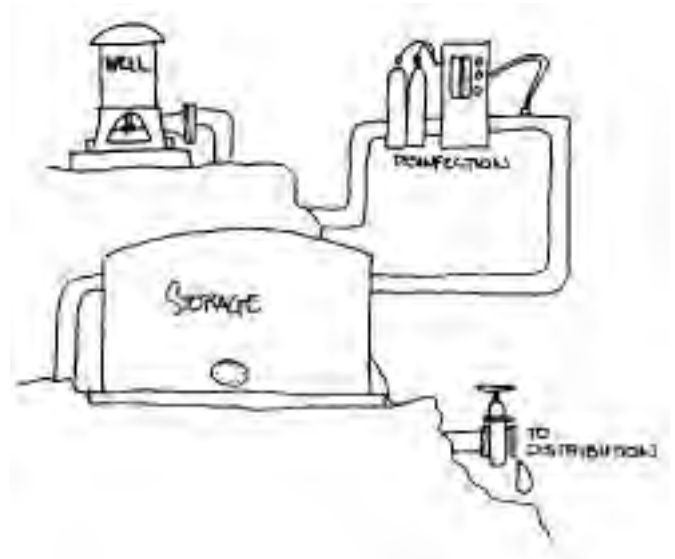

BLANK PAGE



## CHAPTER 6: FLUORIDATION

Fluoride has been added to many water systems around the country for the past 40 years. It is used to prevent tooth decay. Fluoride makes the enamel of the teeth harder and more resistant to the bacterial enzymes and acids that can damage the enamel and result in cavities. The problem with fluoride is that it also causes the other bones of the body to become harder and more brittle. This can cause a higher than normal number of broken bones in older individuals that drink water with an excessive amount of fluoride. This is why fluoride is a Primary Inorganic contaminant and is regulated by the Safe Drinking Water Act. The MCL for fluoride is two-tiered. Notification is required at 2 mg/l and a violation occurs when the level exceeds 4 mg/l.

Fluoride can be naturally occurring in a groundwater system. If concentrations exceed the SDWA MCL, the system will have to notify the public that the standard has been exceeded every month. In systems with a high fluoride concentration, people will tend to develop gray or mottled teeth. The optimum range for fluoride concentration is considered to be between 0.8-1.2 mg/l. The range is based on average ambient air temperature. Higher annual average temperatures require lower dosages, since people drink more water when it's hot.

### FLUORIDE FEED SYSTEMS

Fluoride is commercially available in several forms. It can be purchased in a dry form as sodium fluoride (NaF) or sodium silicofluoride ( $\text{Na}_2\text{SiF}_6$ ). It is also available as a liquid. The liquid form of fluoride is available as hydrofluorosilicic acid ( $\text{H}_2\text{SiF}_6$ ). This chemical is also sometimes called fluosilicic acid and hydrofluosilicic acid.

Fluoride is normally fed into the system as a solution, although dry chemical feeders can be used in very large systems. Hydrofluorosilicic acid is more commonly used for liquid feed systems. Positive displacement diaphragm metering pumps, like those used for hypochlorination sites, are used to feed the fluoride into the system. These pumps are subject to the same types of operational problems. These issues are covered in the Mechanical Systems O&M chapter.

### SODIUM FLUORIDE SATURATORS

Small systems that use sodium fluoride will probably dissolve it and feed the solution with a metering pump. The equipment used to dissolve the dry chemical is called a saturator. At saturation the fluoride strength will remain constant. Water quality will impact the actual saturation concentration. Hard water can create scaling problems as calcium and magnesium fluorides precipitate out as scale. Water with over 10 mg/l of hardness can create scaling problems. Water softeners must be used upstream, in most cases, to prevent these scale deposits.

per million (ppm). These are very small units reflecting concentrations that are essentially on a part per million basis. To get some idea of how small a concentration this really is it should be pointed out that 1% is equal to 10,000 mg/l or ppm.

The chlorine dosage is the amount of chlorine that is added to the water. The dosage can be determined from the number of pounds of chlorine used and the number of millions of pounds of water treated.

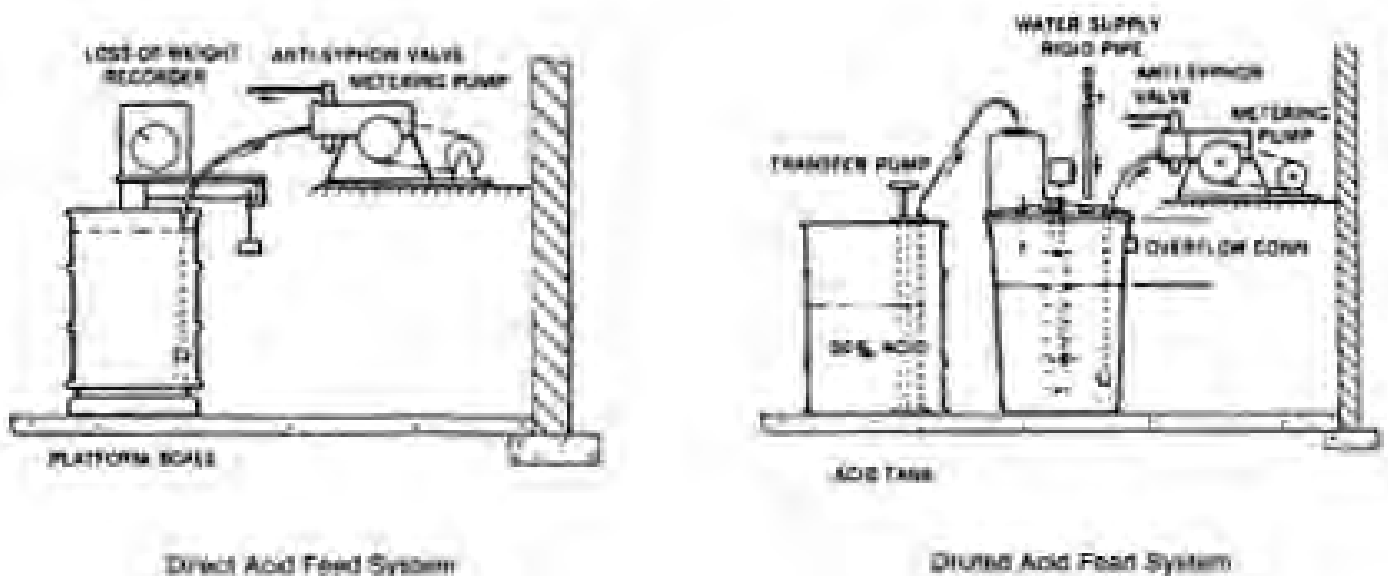

Figure 6.1 - Fluoride Feed Systems

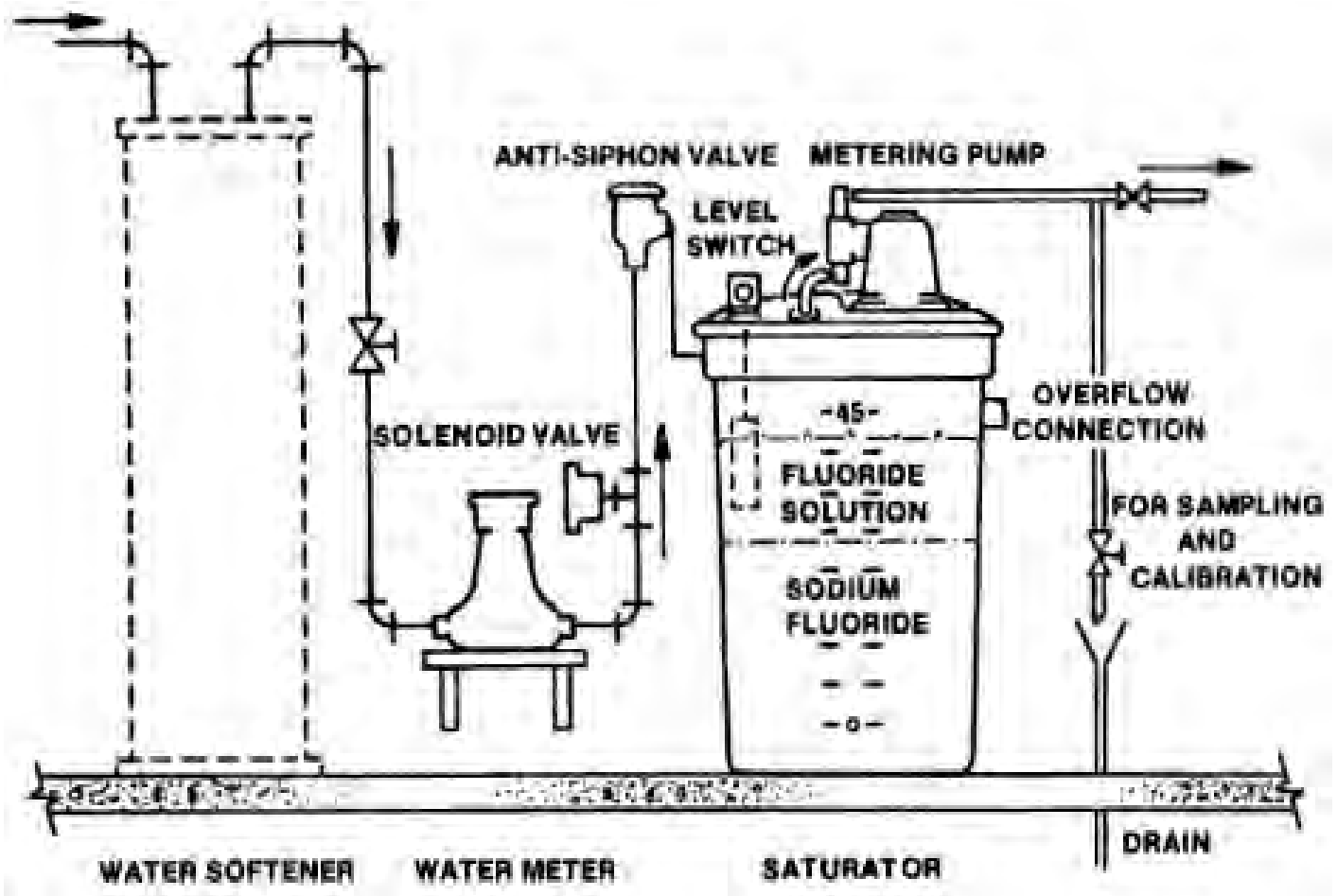

Figure 6.2 - Sodium Fluoride Saturator

### MONITORING FLUORIDE CONCENTRATIONS

A system that adds fluoride must take care not to overdose and exceed the SDWA MCL. Although a high concentration for a short duration will not cause any immediate health risks to customers, a violation of the SDWA will require public notification. This can lead to a public relations problem that could have been avoided with more careful monitoring. This is particularly important in systems that have naturally occurring fluoride in the raw water. Systems that add fluoride should monitor the concentration in the system on a daily basis.

---

### References

Office of Water Programs, California State University, Sacramento, *Water Treatment Plant Operation*, Volume 2, 4<sup>th</sup> ed., Chapter 13  
 NMED, *Drinking Water Regulations*

---

## BASIC STUDY QUESTIONS

1. Why is fluoride added to drinking water?
2. Which chemicals can be used as sources of fluoride?

## BASIC SAMPLE TEST QUESTIONS

1. What is the optimum concentration of fluoride in water?
  - A. 0.2-0.4 mg/l
  - B. 0.8-1.2 mg/l
  - C. 2.0-4.0 mg/l
  - D. 8.0-12.0 mg/l
2. What factor is used to determine the optimum dosage of fluoride?
  - A. Air temperature
  - B. Water temperature
  - C. Fluoride solution temperature.
  - D. pH



## ADVANCED STUDY QUESTIONS

1. What type of equipment would be used to feed liquid fluoride?
2. Why is fluoride an Inorganic Primary Contaminant?

## ADVANCED SAMPLE TEST QUESTIONS

1. Liquid fluoride is delivered as:
  - A. Sodium Fluoride
  - B. Hydrofluorosilicic acid
  - C. Sodium Silicofluoride
2. If a system adds fluoride, fluoride testing should occur:
  - A. Daily
  - B. Weekly
  - C. Yearly
  - D. Every three years

BLANK PAGE

# CHAPTER 7: DISTRIBUTION

## PIPED SYSTEM

A piped system can vary from simple to extremely complicated. Most piped systems have the same basic components; pipes, valves, fire hydrants, service connections and reservoirs. Piped systems may also have pumping stations. The following is a description of the various components that could be found in a piped system excluding pumping.

## MAIN LINE PIPING MATERIALS

### GRAY CAST IRON PIPE (GCIP OR CIP)

#### Pit Cast & Spin Cast

Gray cast iron pipe used in the waterworks industry is manufactured to meet AWWA<sup>1</sup> standard C-106. This is some of the oldest piping material in use today. Over 200 cities in the US have pipe installed that has been in use for over 100 years. Gray cast iron pipe was first manufactured using a process called pit casting. In this process the molten iron was poured into a mold and allowed to cool. In 1925 a process called spin casting was developed. In this process molten iron is injected into a spinning mold. The result is a pipe of consistent diameter and wall thickness.

### DUCTILE CAST IRON PIPE (DCIP OF DIP)

Ductile cast iron is not an alloy. It is formed by injecting magnesium into molten cast iron. The treatment changes the carbon structure of cast iron from a flake to a spherical shape. This alteration results in a material of high strength. It can withstand high impacts, both internally and externally, it has great beam strength (won't break easily), and is much better in resisting corrosion than gray cast iron.

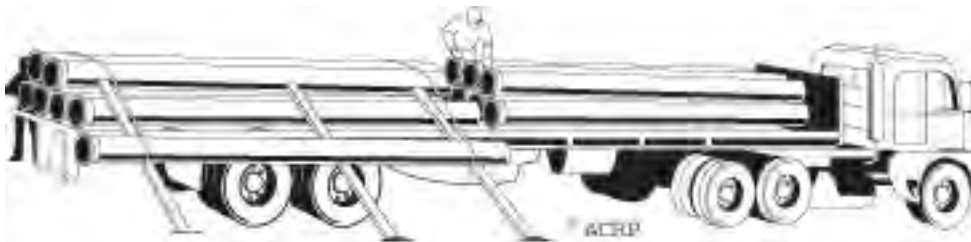

Figure 7.1 - DIP on Truck

Table 7-1 - Pipe Types

### ABBREVIATIONS FOR WATER PIPES

- Cast Iron Pipe (CIP or GCIP)
- Ductile Iron Pipe (DIP or DCIP)
- Steel Pipe (ST)
- Asbestos-Cement Pipe (AC)
- Concrete Cylinder Pipe (CCP)
- Reinforced Concrete Pipe (RCP)
- Polyvinyl Chloride Pipe (PVC)
- High Density Polyethylene Pipe (HDPE)

### Manufacturing Process

Ductile cast iron pipe is commonly manufactured using the spin cast system, in which molten cast iron is injected into a spinning mold. The mold may be either metal or sand lined.

### Size

DCIP pipe is available in sizes ranging from 3" to 54" and comes in 18' and 20' lengths. The hydraulic capabilities and corrosion resistance of the pipe are enhanced by lining it with a thin coating of cement mortar. Under these conditions the Hazen and Williams "C" Factor<sup>2</sup> for the pipe is 140.

### Joints & Fittings

Ductile cast iron pipe is commonly connected using **mechanical joints**<sup>3</sup> (M.J.), flanges or the various common rubber ring push-on joints [see Figure - 7.2]. Fittings used are commonly made of gray or ductile cast iron and use M.J. or hub joints [see Figure - 7.3]. Service taps are made by directly tapping the line or using service saddles.

<sup>1</sup> **AWWA** - American Water Works Association - An association of waterworks personnel, equipment manufacturers, suppliers, and engineers.

<sup>2</sup> **"C" Factor** - The factor used in the Hazen and Williams equation for determining headloss. The "C" Factor is a representation of the hydraulic roughness of the pipe. The larger the number the smoother the pipe is hydraulically.

<sup>3</sup> **Mechanical Joint** - A joint used on cast iron valves, fittings, fire hydrants, and cast iron pipe. The joint consists of a rubber gasket and follower ring that are held to a flange by a row of bolts. The gasket is compressed between the follower ring and flange seat.



Figure 7.2 - Rubber Ring Push-on Joint



Figure 7.3 - Mechanical Joint

**ASBESTOS CEMENT (A.C.) PIPE**

A.C. pipe is also referred to as Transite™, which is the trade mark of the Johns-Manville Corporation, one of the first US manufacturers of the material. The pipe is made by spraying a solution of portland cement, long fibrous asbestos, silica sand and water onto a spinning anvil. The pipe is then shaped and placed in an autoclave to dry.

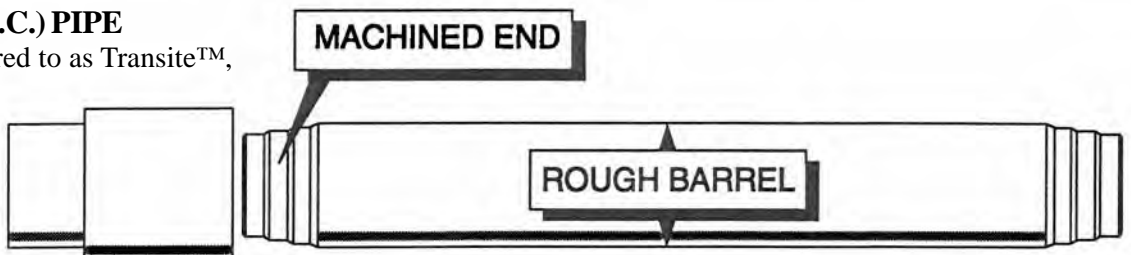

Figure 7.4 - Asbestos Cement (A.C.) Pipe

may be made by direct tapping of the line or by using a service saddle.

**Size**

A.C. pipe is available in sizes from 3" to 36" and comes in a standard length of 13 feet. There are two common dimensions associated with A.C. pipe. The outside dimension of the pipe itself is referred to as the "rough barrel". The outside dimension where the coupling fits is referred to as the "machined end". To reduce the amount of field machining required during construction the manufacturers make short sections of pipe that are 3'3" and 6'6" in length. When the short sections are manufactured similar to the regular pipe they are referred to as MEE (machined each end). However, short sections are also manufactured with machined end dimensions as the outside diameter. This type of section is referred to as MOA (Machined Over All).

**Joints**

The material is connected together using a double bell coupling with a rubber ring in each end. Fittings and valves used on AC pipe are commonly made of cast iron using a rubber push-on ring for connection. Service line connections

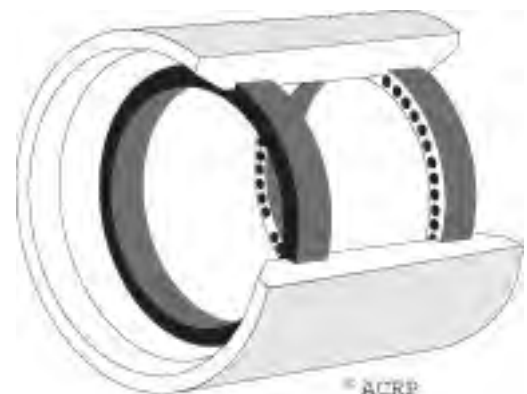

Figure 7.5 - AC Coupling

**STEEL PIPE**

Steel pipe used in the waterworks industry in sizes above 6 inches is manufactured to meet AWWA C-200 standard. Smaller diameter lines used are NSF<sup>4</sup> (National Sanitation Foundation) approved. These materials may be manufactured by anyone using a variety of means. These materials fall into two categories; mill pipe and fabricated pipe.

**Size - Mill Pipe**

Steel mill pipe is available in sizes from 1/8 inch to 36 inches and commonly comes in 21 foot lengths. Two of the most common mill pipes used in the waterworks industry are

Standard Weight and Scheduled Pipe. The two common Scheduled Pipes are Schedule 40 and Schedule 80. In sizes from 1/8 inch through 10 inches, standard weight and Schedule 40 pipe are the same OD and wall thickness. From 12 inches through 24 inches, the wall thickness of the standard weight pipe remains constant while the schedule 40 pipe wall thickness increases with an increase in diameter.

**Joints**

Steel pipe is coupled by a variety of methods; threaded couplings, welded couplings, Dresser™ type couplings, Victaulic™ couplings, flanges and rubber ring push-on joints.



**Figure 7.6 - Dresser Type Coupling**

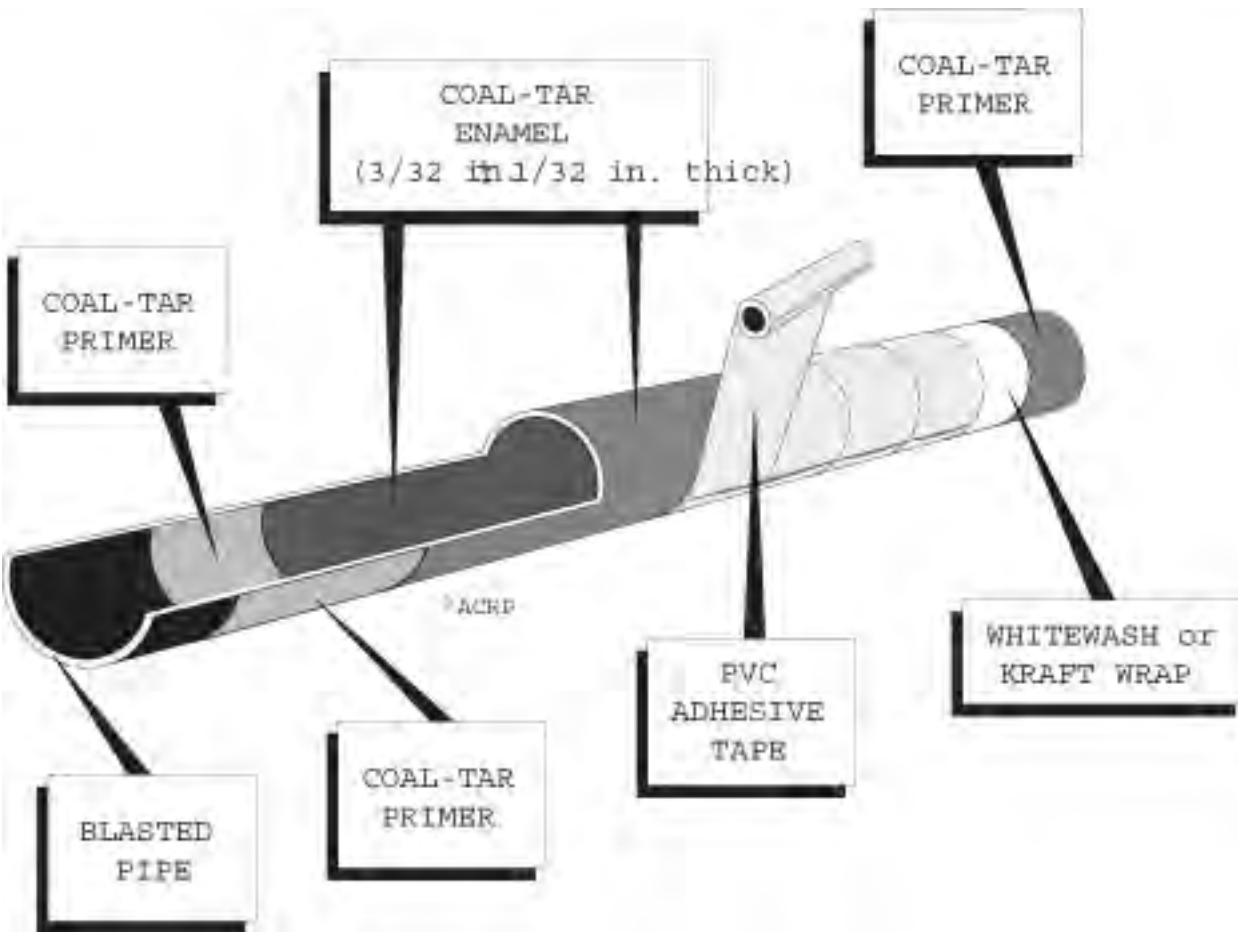

**Figure 7.7 - Steel Pipe, dipped and wrapped**

<sup>4</sup> NSF - National Sanitation Foundation

**PVC - POLYVINYL CHLORIDE PIPE**

PVC water pipe is made from unplasticized polyvinyl chloride. The material is heated and shaped by forcing it through a die in a process called extrusion. Although the material was introduced into the U.S. in the late 1940's it only gained wide acceptance from the larger water systems when a thicker walled material was developed and an AWWA standard was adopted. The standard that governs most of this thick walled PVC pipe is called C-900. This distinguishes it from other PVC water pipe that has a thinner wall.

The material is light weight and easy to install. It is virtually corrosion free and therefore has gained relatively wide acceptance as a major pipeline material.



**Figure 7.8 - PVC - Integral Bell & Spigot Joint**

**Types & Sizes**

PVC used for water lines is generally available in sizes of 1/2 inch through 16 inch. There are three common types of PVC utilized; Schedule pipe, Pressure pipe and Class pipe. The primary difference between these various pipe types is wall thickness, outside diameter and burst strength.

**Size & Lengths**

At the time of printing, scheduled pipe was available in sizes from 1/8 inches through 24 inch, Pressure pipe is available in sizes from 1.5 thru 12 inch and Class pipe is available in sizes from 4 thru 12 inches. All three types are available in standard 20 foot lengths. PVC pipe has a Hazen and Williams

“C” fac-tor of 150. PVC pipe is available in various wall thicknesses and outside diameters. This has resulted in considerable confusion about which pipe is which. In the discussion below we offer some clarification.

**Joints**

PVC Class and Pressure pipe can be connected using either an integral bell and spigot process or a double ended bell. In either case the gasket is a rubber material and the joints are made by lubricating the pipe and pushing it into the coupling or bell.

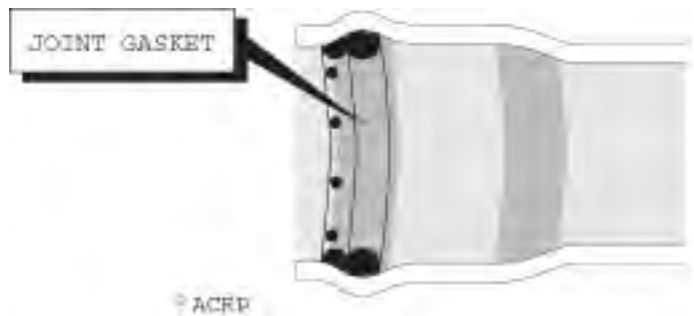

**Figure 7.9 - PVC Integral Bell Cross-section**

**CONCRETE PIPE**

Concrete pipe used in the waterworks industry is manufactured in accordance with AWWA standards C-301 & C-302. This piping material is primarily used for large diameter lines. Several types of concrete pressure pipe are used. However, the most common types of concrete pipe used are manufactured by wrapping a wire around a steel cylinder and using a cement coating to cover the steel cylinder both internally and externally.

**Prestressed Concrete Pipe**

Concrete cylinder pipe is also available in various prestressed forms. The prestressed pipe is made similar to the pretensioned, except that the wire wrap is much smaller and under much higher tension (up to 170,000 psi). This material is usually used only on large diameter lines. (commonly 36" to 240")

**Pretensioned Concrete Cylinder Pipe**

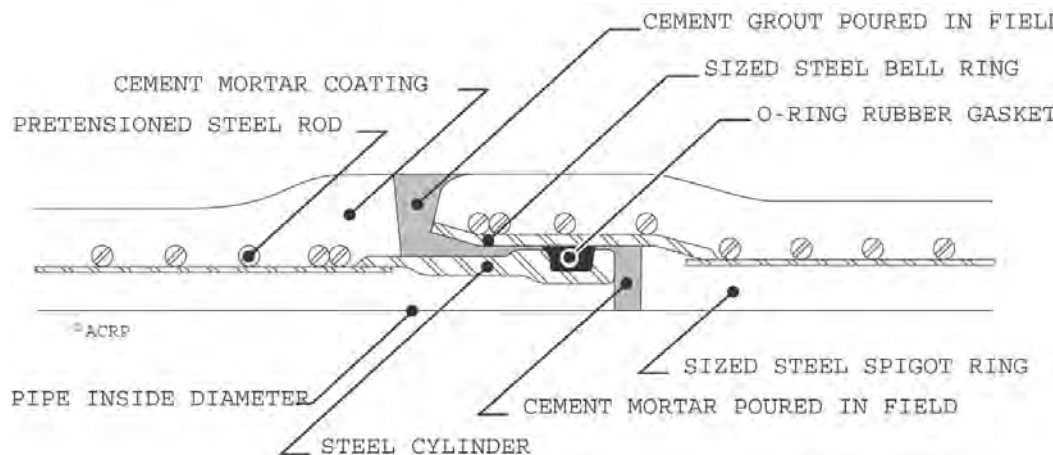

One of the most common concrete pressure pipes is referred to as pretensioned concrete cylinder pipe. (A cross section of this pipe is shown below.) This pipe starts from a steel cylinder. The cylinder is wrapped with a steel rod that is under tension. The interior and exterior of the pipe is coated with cement mortar. The cement is then cured in an autoclave. Concrete cylinder pipe is an extremely durable material with high hydraulic capabilities.

**Figure 7.10 - Cross-section of Pretensioned Concrete Cylinder Pipe Joint**



### **Sizes of Cylinder Pipe**

Pretensioned concrete cylinder pipe is available in sizes from 12" to 42" and in standard sections of 32 and 40 foot lengths.

### **Joint Types**

This pipe is connected by bell and spigot rubber ring push-on joints (see the drawing on the previous page). Once the joint has been connected the exposed steel must be coated with concrete to protect the steel cylinder from corrosion.

### **HDPE PIPE**

High Density Polyethylene (HDPE) is manufactured using a heat extrusion process and polyethylene resins. The material is used for water services lines and main lines. There are a wide variety of HDPE piping materials manufactured. The primary material used for drinking water is manufactured to meet ASTM standards D1248 and AWWA C-906. The designation used to identify the resin used to produce this piping material is ASTM and the PPI (Plastic Pipe Institute) designation is PE 3408.

### **Size & Lengths**

HDPE, PE 3408 is manufactured in pressure ratings from 65 psi to 220 psi. The most common HDPE used in water systems has a pressure rating of 160 psi. HDPE pipe is available in sizes of 3/4 inches through 16 inch. Sizes of 3/4 inch through 1.5 inch is available in rolls of up to 500 feet, 2 inch is available in 350 foot coils. Larger sizes, 3 inch and up, are available in 20 and 40 foot lengths. All material used for drinking water is manufactured to IPS (Iron Pipe Size)

outside dimensions. The wall thickness of the pipe will increase with an increase in pipe diameter. The wall thickness is selected to maintain a ratio of pipe OD divided by wall thickness of 11. This is called the SDR (Standard Dimension Ratio).

### **Joints**

The most common connection for HDPE pipe is a heat fused weld. The pipe is commonly connected using a butt welding process. The welding of HDPE takes special equipment and special training. Small diameter (less and 2 inch) can be connected using compression fittings and stainless steel or brass insert fittings. There are special stainless steel adapters that allow the pipe to be connected using the Victaulic type of coupling. Flanged connections can be made by welding a butt or socket weld flange to the pipe. Repairs can be made to the pipe using typical cast iron couplings, providing a special stainless steel insert is placed in the pipe to prevent collapsing of the pipe.

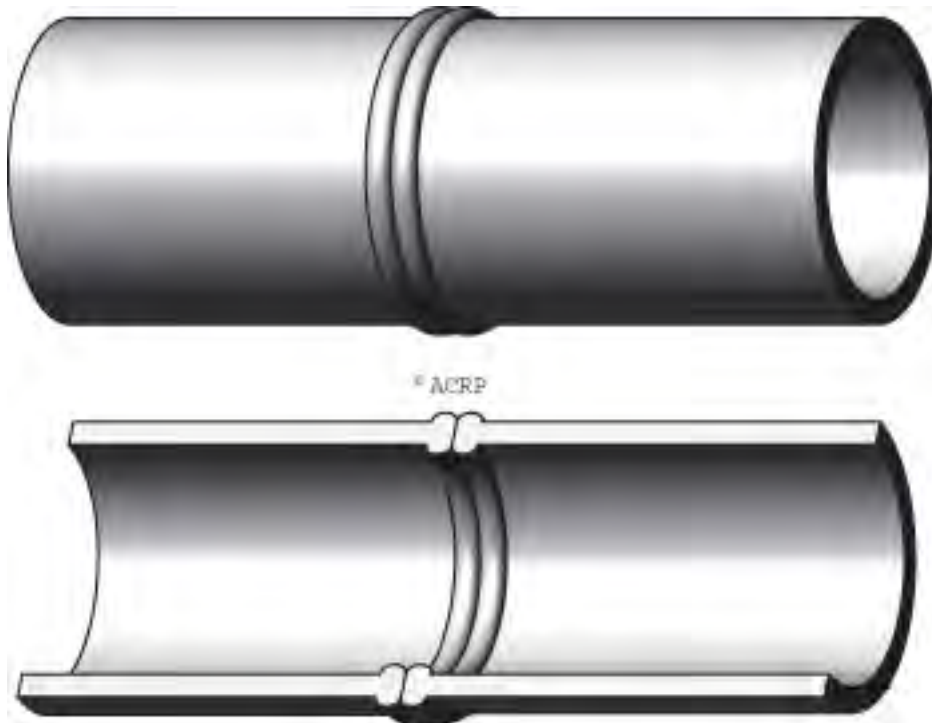

**Figure 7.11 - HDPE Heat Fused Welded Joint**

## BEDDING & BACKFILLING THE PIPE

### BEDDING

Examine Figure 7.12 - *Pipe Bedding*, and note the following Right and Wrong ways of bedding:

1. Right – Backfill material completely covers the trench bottom.
2. Right – Couplings are not resting on the trench bottom.
3. Wrong – Backfill material has only been placed under the couplings.
4. Wrong – There is no backfill material and the pipe is not resting on the original trench bottom.
  - Couplings – Never allow couplings to rest on or settle down to original trench bottom.
  - Pipe – Make certain that pipe barrel is given an even bearing for its full length.

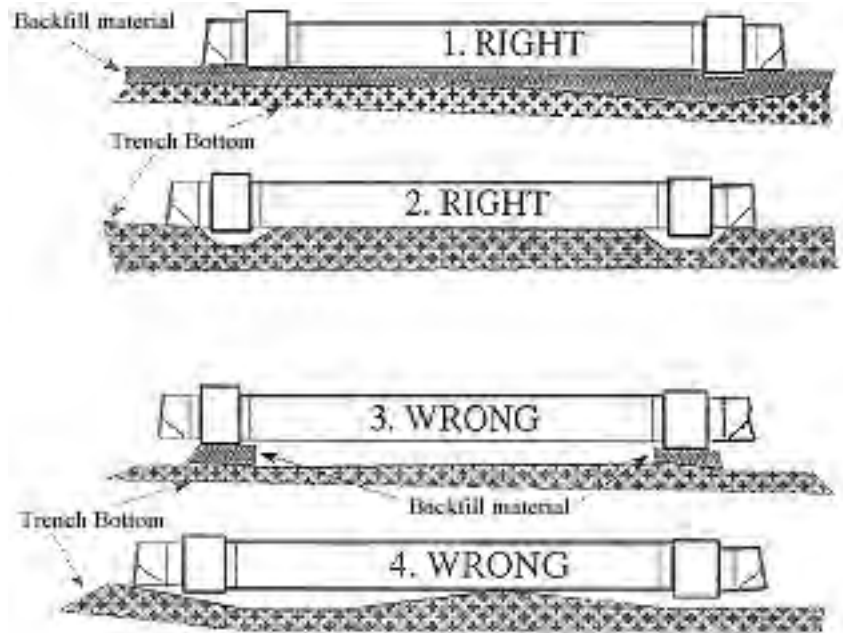

Figure 7.12 - *Pipe Bedding*

### BACKFILL CONSIDERATIONS

The type of backfill material used is also a very important factor in the protection of all pipes, especially plastic pipe. If rocks or other abrasive material are present in the backfill, a sharp edge may cut into the line and cause a leak to develop. To prevent this kind of damage from happening, a select backfill material, preferably sand, should be used. The backfill should be carefully added and properly tamped to help support trench loads. The backfill material should completely surround the pipe. It should be tamped when the pipe is still half exposed and again when the pipe is covered by about 6 inches of material.

An important step in the construction job is the initial backfill over and around the pipe. It is estimated that 90% of underground pipe failures can be traced to lack of proper bedding and initial backfill. The operator should follow these steps:

- Bedding material should be added around the pipe up to over one-half of the diameter and compacted to provide support to the underside of the pipe.
- Next the pipe should be covered to 12 inches above its top side with compacted bedding material or compacted select backfill material. Proper bedding and good side-fill compaction will result in a 150% increase in supporting strength.
- The remaining trench backfill should be select material. Native backfill can be used if it contains no large rocks, lumps of compacted soil or pieces of organic matter such as root, limbs, or grass.
- Backfill should be compacted by mechanical tamping or by water flooding. Otherwise, the soil can settle around the pipe and cause trouble long after the work is completed.

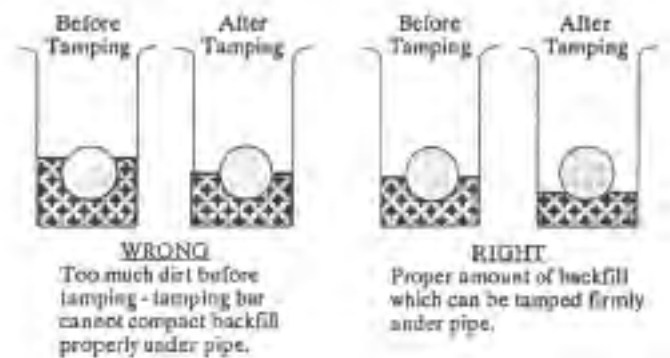

Figure 7.13 - *Backfilling the Pipe*

Plastic pipe should not be used under railroad crossings, highways, or anywhere that vibration and stress loads are a problem. These situations call for iron or steel pipe that can withstand these external pressures. If a plastic line is used, the PVC pipe should be installed in a steel conduit. Even if the reinforced PVC is used, a conduit is worth its cost. In addition to this, a conduit will make it much easier to replace the damaged water main. Keep PVC water lines as far as possible from high-way right of ways. All easements to both highways and private property must include access for construction, repair and inspection.

Finally, PVC lines are impossible to locate with a metal detector. This can present problems when repairs must be made. To remedy this situation, a roll of metallic tape can be used to mark the line. After the back-fill has been tamped properly the tape should be placed on top of it prior to refilling the trench. This can be located with a metal detector and save time and effort when repairs must be made.

## PIPE PRESSURE RATINGS

Some types of pipe are available in more than one pressure rating. PVC pipe is available in several pressure ratings. Schedule 40 and Schedule 80, the latter being rated at a higher pressure, are the most common types of PVC. The difference in the dimensions of these two is in the pipe wall thickness. They will both have the same ID, but different outside diameters, requiring different sizes of clamps or fittings.

## SEPARATION OF WATER AND SEWER LINES

When installing new water lines certain precautions must be taken when crossing or laying parallel to sewage lines. To prevent cross-connections or contamination of the drinking water, the water line should be separated by at least 10 feet horizon-tally when the lines are side by side. If the water line crossed a sewage line, the water line must be on top and the lines sepa-rated by a vertical distance of at least 18 inches. If the sewer line crosses over the water line it must have a 20 foot water tight casing around it with the water line being 10 feet from either end of the casing. It is preferable to cross as close as possible to the middle of the section of water line so the ends of both lines are as far from each other as possible.

## CLEANING WATER LINES

Some systems find that the build up of scale, tuberculation, or bio-slime can reduce the carrying capacity of the distribution system piping. Pigs can be used to clean the inside of the piping. A pig is a bullet shaped foam swab that can be pushed through a pipe to clean it. The pig must be inserted through a special launch site and is propelled through the pipe by water pressure until it reaches an extraction point. It scours the line and pushes the debris ahead of it.

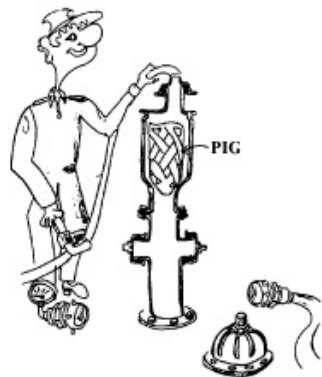
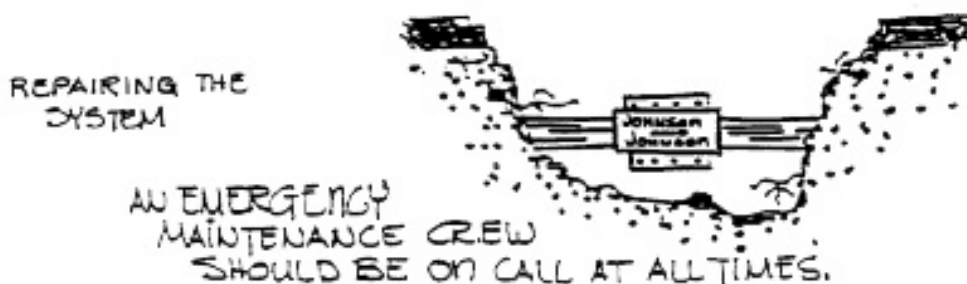

Figure 7.14 -  
Launching a Pig

## WATER LINE REPAIRS

Broken water lines are a major concern of all water opera-tors. They not only create the problem of disruption



of service but also represent the loss of revenues from the water that is lost. This can result in excessive amounts of water that is unaccounted when comparing production and billing. This level should not exceed 10% of production. The first concern when a leak is reported, or detected by a rapid drop in the storage level, is to locate the point where the line is broken.

## LOCATING LEAKS

Leaks mainly occur at the joints. Often large leaks will be spotted and reported by customers. If not, look for grass and weeds that are greener and larger than others during the growing season. For rural areas, one method of locating losses in excess of 10% is to isolate valves to guide you to the source of the leak. This method works only when the system is as near static conditions as possible. This means working at 2 or 3 A.M. First, shut off the pumps, so water will be flow-ing only from the storage tank into the distribution system. If you are purchasing water, close the valve near the master meter.

Now that you know from which direction water is flowing, go to the first valve on the main line and slowly begin to close it. When the valve is almost closed, place the bottom of valve wrench on the valve nut and the top against the bone in front of your ear. If water is moving rapidly through the valve, you will hear a "singing" noise. If you hear no such noise, then the leak is a small one or the cause of the water loss is not a leak. If you did hear the "singing", completely open the valve and go to the next valve on the main line and repeat the procedure. If the noise is again heard, open the valve and continue to the next one.

Continue to go to each valve until you come to one where the noise cannot be heard. That tells you that there is a leak between this valve and the last one. If there are several branch lines between the two valves, partially close each and listen to it. When the right line is located and if it is several miles long, con-tinue to move down the line listening to valves. When the source of the leak is isolated within a certain section, the remaining work can be accomplished during a more reasonable daylight hour. Be certain that all of the valves that were closed are opened and any pumps turned back on.

During the day, close the valves, on each end of the section to be isolated. Turn off all of the curb stops on that line except one. At that one residence, connect a pressure gauge and watch it closely for thirty minutes. A slow continuous drop in pressure would indicate a leak. A steady pressure followed by a quick drop would indicate an illegal tap or that someone has turned their water back on. If there is a leak, walk directly over the line in that section and note any damp areas, areas of very green and large grass and weeds, or an unusual collection of insects. If snow is on the ground, note

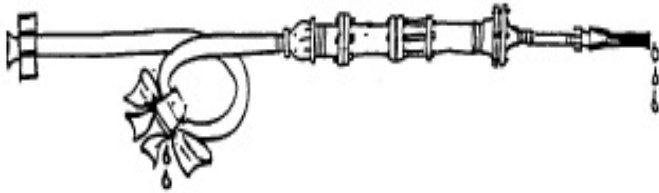

any melted spots directly over the line. Another method of locating a leak that has not surfaced is to drive a metal rod into the ground and note if the end of the probe is wet or if water begins to rise in the hole that is created.

### REPAIRING THE LEAK

Once the leak has been located it is a good public relations practice to inform residents in that area that service may be interrupted while the repair is being made. All businesses in the area should also be notified so that equipment that might be damaged by the loss of water service can be shut down. This may take a little extra time but may also save a lot of unnecessary hard feelings between customers and the water system.

1. Assemble the proper equipment and notify the customers of the interruption. If the work is going to happen at some time in the future, notification should happen at least 24-48 hours in advance.
2. Isolate the break by shutting all gate valves necessary to stop the flow of water. Tag each valve according to OSHA LOTO guidelines. Identify all closed valves on a map.
3. Mark the line using a line locator or probe. A line can also be spotted by siting along two or more valve cans. Line spots should also be called in for other utilities before attempting to excavate the leaks. Contact NMOC (New Mexico One Call), by phone, dial 811. NMOC will coordinate locating and marking all underground services.
4. If the excavation is going to be over 5 feet deep, make sure that the proper shoring equipment is available or that enough of the street has been closed to adequately slope the trench according to OSHA guidelines. The area around the leak should be large enough to work comfortably, usually one foot on either side of the pipe. A sump hole is dug at one end of the trench to allow the water to flow away from the leak and be pumped or dipped out. Any excavation that is over four feet deep must have a ladder for access. The ladder must extend at least 3 feet above the excavation. They must be located so that no workers are more than 25 feet from a ladder. All spoil must be placed at least 2 feet from the side of the trench.
5. The type of repair clamp or coupling is selected once the line has been uncovered. A wrap around repair clamp can be used if leak is a hole from a blown service or puncture. Lines that developed cracks along the length of a pipe should be cut out and a new section spliced in with compression couplings. Once the damaged section has been removed it is a good idea to flush the lines out to remove any foreign matter that

may have been sucked into the line. Compression couplings are used to reconnect the new section of pipe to the existing line.

6. Backfilling the excavation should be done by hand at first, preferably with sand or gravel. The area underneath and beside the clamp or new section of line should be built up to support the line and 4 to 6 inches of material shoveled in on top of the line. This should be tamped carefully to avoid damaging the clamps and couplings. Once this is completed the ditch may be filled in with the backhoe and should be tamped in 12-18" lifts.
7. Refill the line by carefully cracking a valve at the low end of the line and opening a hydrant or service to vent air out as it fills. Air relief valves can also be used as vents if they are present on that particular section of pipe. The velocity of the water in the line should be kept below 1 fps and should always be controlled from the fill valve rather than the vent valve. If allowed to fill too quickly, water hammer can occur when the water finally fills the pipe.
8. Reopen all gate valves that were closed and double check to make sure the repair is not leaking. Prior to putting the line back in service, it should be disinfected and have BAC-T samples taken.

### DISINFECTION OF WATER LINES

Newly laid water lines or lines that have been repaired should be disinfected before they are put into service. This procedure is standard for all water system components including wells and reservoirs. There are four steps that should be taken to insure that the line has been properly disinfected.

1. Flush the line. This will remove any dirt or debris that may be in the line. Flushing it out is easier than burning it up with chlorine. Minimum velocity should be 2.5 fps. Flushing should continue until an amount of water equal to twice the pipe volume has been discharged.
2. Disinfect the line. Enough chlorine should be added to create a 50 mg/l dosage with a 5 mg/l residual after 24 hours. In some instances a higher chlorine dosage can be used and the contact time can then be reduced.
3. Flush the line again. This should be done long enough to re-move all of the chlorinated water so that "Bac T" samples can be taken.
4. After the line is refilled, take BAC-T samples from the line. If negative results come back, the line is ready to be put into service.

The chlorine should be added at the same point that the water is introduced back into the line. A solution of HTH or, in most small lines, household bleach is normally fed through a corporation stop with a solution pump as the line is slowly filled. Dry HTH should not be put directly into the line or it will be washed to the far end before it dissolves.

In the case of some line repairs, it may not be feasible to keep the line isolated while waiting for the sample results. An acceptable alternative to this procedure is to flush the

line with water that has a free chlorine residual of 0.5 to 1.0 mg/l. Take the BAC-T sample and maintain the chlorine residual until the negative test result returns.

### DISTRIBUTION SYSTEM VALVES

Valves are used to control flow in a water system. Most of the valves in a distribution system are installed for isolation of sections of piping for maintenance and repair. Control valves like pressure reducing valves, altitude valves, pressure relief valves, pressure sustaining valves, and pump control valves are designed to control pressures and throttle flows to prevent damage to the system. Air relief valves can vent trapped air from the system. Check valves allow water to flow only in one direction.

### GENERAL VALVE MAINTENANCE

Valves on the water system should be completely closed and then reopened at least once a year. If not, they may become frozen and inoperative when isolation is necessary.

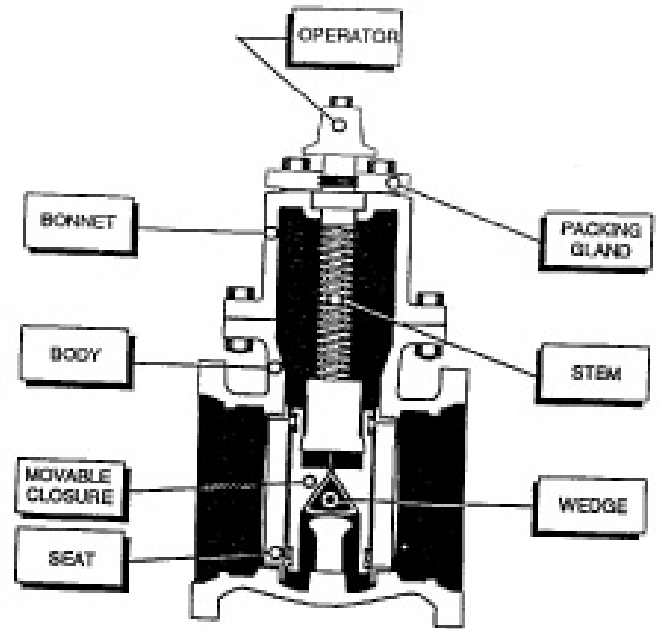

Figure 7.15 - Non-Rising Stem Gate Valve

Table 7.2 - Valve Maintenance

GENERAL VALVE MAINTENANCE DATA	
•	Location of the valve from a reference point
•	Type and size of valve
•	Make of the valve
•	Number of turns to open/shut
•	Dates it was operated
•	Date it was repacked or repaired
•	Condition of the valve

An up to date map should be kept of all the valves in the system plus an individual record of each valve.

Always check the valve stem for leaks. There is a stuffing box on the valve body where the shaft enters the valve, just like on a centrifugal pump. The difference is that, unlike a pump, the packing gland should be tightened to prevent leakage. The packing seldom wears out, since the valve stem doesn't move often. If it does wear out, the stuffing box can be repacked like a pump. When a valve must be disassembled, the valve seat, the valve face, and the disc should be checked for damage.

### GATE VALVES

Gate valves are the most common valves in a distribution system. They are used for isolation of equipment and piping. They should never be used to throttle flow. This will cause damage to the valve face. Open gate valves have the less friction loss than any other type of valve. Gate valves can have plug type disks or split gates. Split gates are used in higher pressure applications. Gate valves can also have rising or non-rising stems. A rising stem is threaded to the valve body and will rise as the valve is opened. Some types of rising stem valves are called outside yoke and stem (OS&Y) valves. A non-rising stem is

threaded to the gate assembly and lifts the gate without rising. Non-rising stems are found on all large buried valves. The number of turns needed to open or close a gate valve that is not gear reduced is equal to 3 times the diameter plus 1-3 turns to seat properly. So a 6" valve will take  $3 \times 6 = 18 + 1-2$  or about 19-20 turns to close. Larger valves will take 2-3 extra turns.

Large gate valves may have a much smaller bypass valve that is piped in around the large valve. In a distribution system, the water pressure can create tons of force against the valve face. When one side of the valve has been depressurized for some reason, the force against the other side can make it impossible to open the valve. The stem will break instead. The bypass valve is much smaller and easier to open (less total force on a smaller surface area.) When the pressure has equalized on both sides of the large valve, all the stem has to do is lift the weight of the gate assembly.

### BUTTERFLY VALVES

Butterfly valves serve the same purpose as gate valves. These valves usually open and close with 1/4 of a turn of the

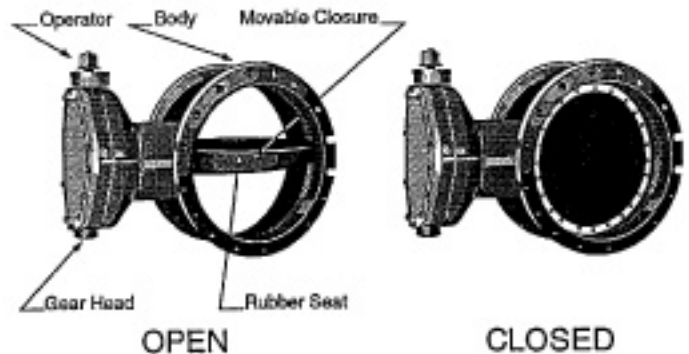

Figure 7.16 - Butterfly Valve

valve disc. Larger valves will have a gear box on the stem and will require a number of turns to open. Butterfly valves are easier to open than gate valves, usually without the need for a bypass, but have more friction loss when open. They can also be used for throttling flow without damaging the disc. Caution should be used when filling a line through a butterfly valve. When a butterfly valve is 30% open, it can pass 90% of its rated flow. Small butterfly valves will simply have a handle, instead of a threaded stem. The handle is normally aligned with the valve disc. When the handle is in line with the pipe, the valve is open. When it's perpendicular to the pipe it's closed.

### **BALL OR PLUG VALVES**

Ball and plug valves are similar to butterfly valves. They have a ball or cone-shaped plug that has a hole in it, instead of a disc. They open and close with ¼ turn. They are the second most common types of valve on most systems. They are used as corporation stops on service lines, curb stops on meter setters, and isolation petcocks on control valve pilot piping. They are seldom used in sizes above 2 ½”.

### **CHECK VALVES**

Check valves are used where flow of water should be in one direction only. The swing check valve should be operated in the horizontal position and the lift check valve is operated in a vertical position. These types of valves are most commonly used on the discharge side of the pumps to prevent backflow and as foot valves on the bottom of suction piping to prevent loss of prime to the pumps.

### **AIR RELEASE VALVES**

Air release valves are used to allow air that may be trapped in the line to escape. The trapped air can create pressure and pumping problems, milky-water complaints, and pressure spikes that resemble water hammer. They are very useful in systems that are in hilly country. They should be located at the top of hills where the trapped air will collect. They are also used on booster pumps and wells to removed trapped air. Combination air

release valves will also let air in when a vacuum occurs. This is done to protect the piping. They can also be used to vent a line that is being drained.

### **CONTROL VALVES**

Control valves are usually one of the least understood components of a water system. They are designed to control the flow of water by reacting to changes in the system and automatically opening or closing the valve to compensate. They are globe valves. They share the same basic design as a hose bib valve. The difference is these valves are hydraulically operated, diaphragm actuated, globe valves. The type of pilot or control mechanism that is placed on the valve determines the specific use of a control valve. A control valve can be used as an altitude valve, a pressure reducing valve, a pressure relief valve, a pressure sustain-ing valve, a pump control valve or a check valve.

### **ALTITUDE VALVES**

An altitude valve is a control valve that is designed to close when an elevated storage tank is full. They are needed when there are several storage tanks at different elevations in a system. Altitude valves will be used on the lower tanks to prevent them from overflowing. Each valve will isolate its tank so that the top tank can be filled and not drain out through the lower tanks. This is one of the most common uses of control valves in water systems. The height of the water in the tank can be ad-justed by turning the adjustment nut or screw on top of the pilot mechanism. Tighten the nut down to raise the water level and loosen it to lower the level. Adjustments should be made in very small increments and several adjustments may be neces-sary before the proper level is maintained.

### **PRESSURE REDUCING VALVES**

Another common use of a control valve is found in areas where the differences in elevation in the system create unacceptably high water pressures in the lower elevations. With the proper controls, a control valve can reduce and

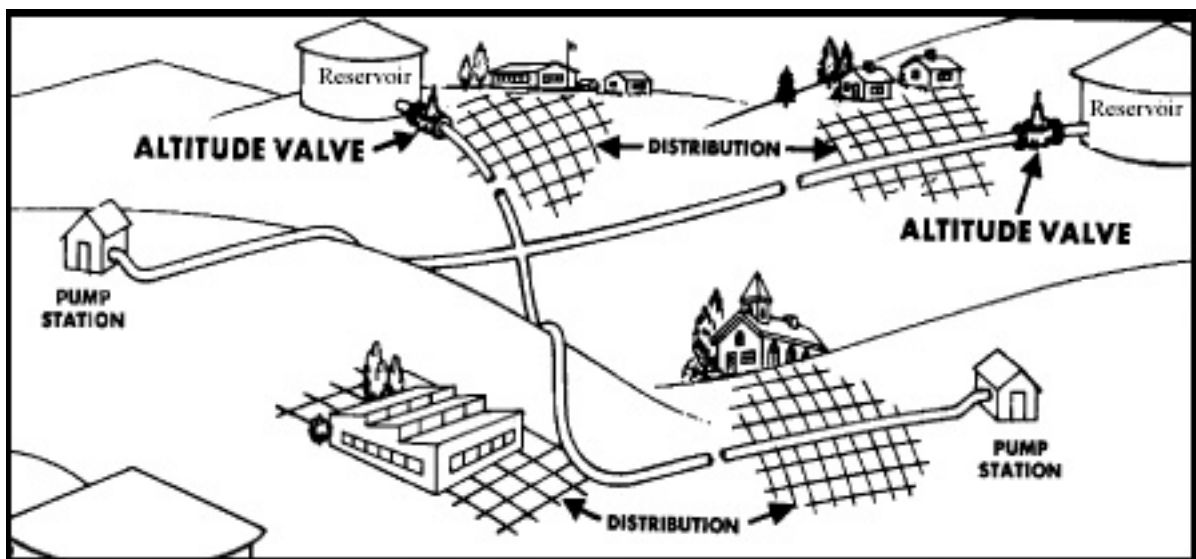

Figure 7.17 - Altitude Valve

maintain a steady pressure on the downstream side of the valve. The setpoint for the downstream pressure can be increased and decreased by tightening and loosening the pilot control screw. There is a maximum and minimum flow that a PRV can handle. When the flow drops too low the valve will chatter or start slamming open and closed. This will create severe water hammer problems. To avoid this problem, PRV's are sometimes installed in pairs with a small valve in parallel with the larger valve. The small valve is set at a higher pressure. This will allow it to handle the low flows and keep the large valve shut so it doesn't chatter.

**PRESSURE RELIEF VALVES**

Pressure relief valves are used to provide protection against high pressures that may develop in the system. They should be located in any part of the system where pressure is controlled by a pressure reducing valve. They are also used at booster pump stations and on wells that discharge directly to distribution. When the valve senses a high pressure upstream, it will open to pass enough water to drop the pressure back down to setpoint. The water is discharged to a storm sewer or ditch. If the pressure upstream drops, it will close automatically. The setpoint should be about 10-15 psi higher than the normal system pressure at that location.

**PRESSURE SUSTAINING VALVES**

In some systems there are areas of very heavy water demand that can sometimes "rob" the pressure of upstream areas. The control valve will act to maintain the desired upstream pressure during these conditions and throttle the flow of water to the area of heavy demand.

**FIRE HYDRANTS**

The fire insurance rates for residents on the system will be dependent, in part, on the proper spacing and discharge

cap-abilities of the fire hydrants in the system. Hydrants should not be more than 500 600 feet apart in residential districts. The spacing requirements in industrial and rural districts may vary. They should be located at the end of every dead end line. Hydrants should be operated every 6 months and flow tested annually.

Fire hydrants should never be placed on less than a 6 inch line if it is to be used for fire protection. In addition to provide fire protection, hydrants can also be useful for flushing lines, venting lines as they are filled, and pressure and flow testing. Hydrants on smaller lines (4 inch and down) will not supply enough water to fight a fire but may be used to flush dead end lines. The traffic model of a dry barrel hydrant comes with special breakaway unions on the stem and flanges on the upper barrel that allow it to break cleanly if hit by a vehicle. Hydrants must be installed with the nozzles at least 18 inches above grade. This is the clearance needed to operate a hydrant wrench when removing the nozzle.

Care must be taken to avoid damaging landscaping or creating a safety hazard in traffic when flushing a hydrant. There are two types of fire hydrants used in water systems; wet barrel and dry barrel. A wet barrel hydrant is always pressurized and the main valve is at the top of the hydrant barrel. A dry barrel hydrant has the valve at the bottom of the barrel and a drain hole that drains the barrel when the hydrant is closed. These hydrants are used in areas where freezing occurs in the winter. Never operate a dry barrel hydrant with the main valve cracked to throttle flow. The drain hole will be open and jetting water to undercut the sidewalk and hydrant, anytime the main valve is not completely open.

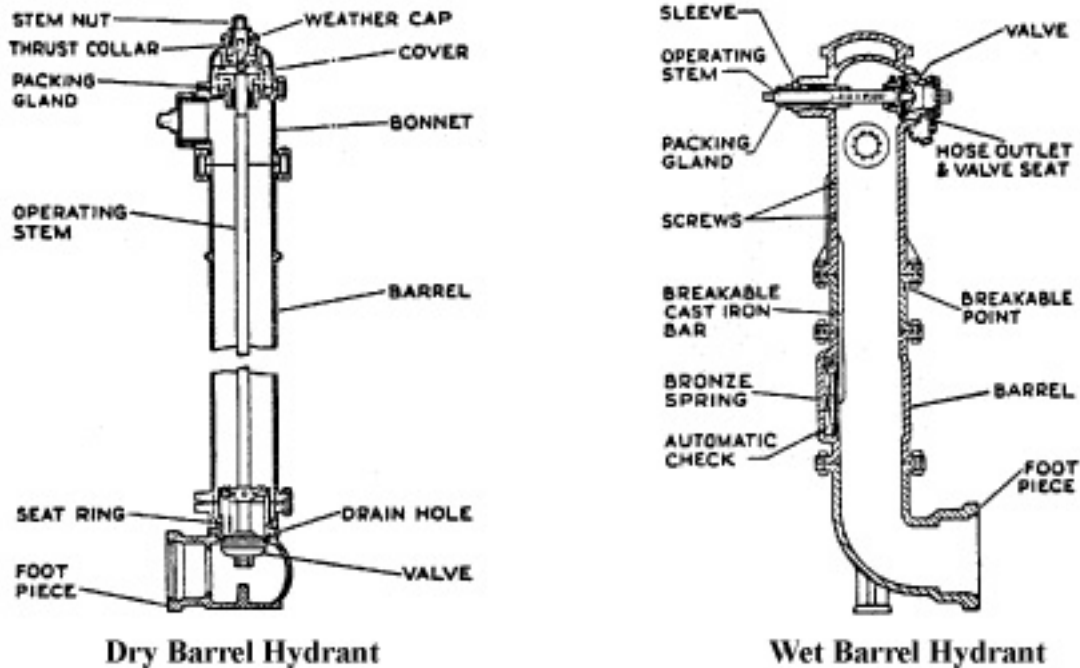

Figure 7.18 - Fire Hydrants

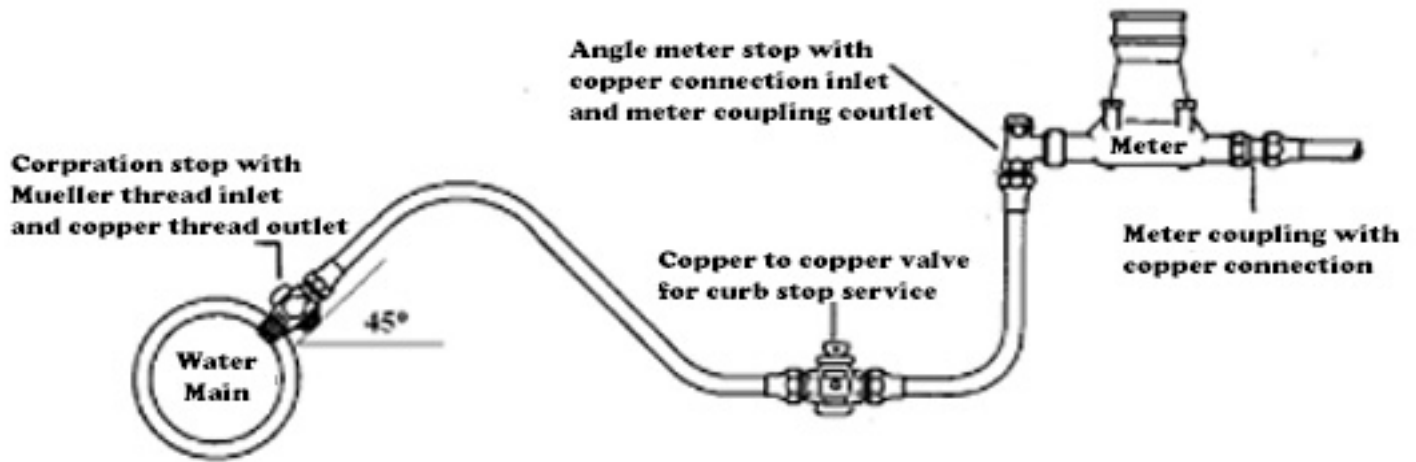

Figure 7.19 - Service Line Installation

## SERVICE LINES

Services connect the customer to the main in the street. Services are installed using a tapping machine to drill and connect a corporation stop to the main. The tap is normally done while the main is under pressure. This is called a “wet” tap or “hot” tap. Taps can be made by inserting the corp stop directly into the main or the corp stop can be installed on a saddle that’s strapped to the pipe. Taps should be made at a 45% angle from horizontal so that they are less likely to be pulled by a backhoe.

The service line is usually copper, PVC or polyethylene pipe. Galvanized and lead services should be replaced, since the former is prone to corrosion and the latter can cause lead problems if the water is corrosive. The service line should have a bend or goose neck in it at the corp stop. This will allow the service to flex slightly if the trench or piping shifts after backfill. A curb stop should be installed in the easement so that the service can be isolated. Sometimes a meter stop on the yoke is used instead of a cub stop. A service line leak may require killing the main or using a crimping tool to isolate for maintenance when a meter stop is used. Service lines and meters must be laid below the frost line for the area or freezing will become a problem in the winter.

## WATER METERS

The meter is the primary piece of equipment in a water system that has a direct bearing on income. It is the cash register for the system. Many small systems do not have meters. Billing is based primarily on the size of the service and is a fixed rate. Water meters encourage conservation and distribute the cost of service in proportion to its use. Even though they are critical to maintaining the cash flow for a system, meters tend to be neglected more than any other piece of water equipment. An inaccurate meter cheats the wa-ter system and also all the customers whose meters are accurate.

When a meter becomes worn or broken it always under-records and will give water away to the customer. This is

not a good point to impress upon a customer who is sure he or she is being charged for too much water. Instead check the meter readings for the last month. It may be that an error has been made in reading the meter which can be corrected by promising a credit on the next month’s bill and re-reading the meter to make sure the books are straight.

If this does not correct the situation go out to see the customer and take a 5 gallon bucket and a new meter with you. When you get there have the customer turn off all water using appliances in his or her home and then read the meter. Fill the bucket up twice and then re read the meter. If the meter reads 10 gallons it is indeed accurate. If the reading is less than 10 gallons the meter is worn and should be replaced. At this point the customer may wish he had not called.

If the meter reading is over 10 gallons then there is a substantial leak in the customer’s plumbing. This can be con-firmed by re checking the reading as the customer watches and then explain the situation to them. By the time this is done, enough water should have leaked out to make the meter reading change, which identifies the problem as a leak and not the meter.

Meters should be maintained and tested to insure that they are accurate. A meter that has worn out will under register and rob the system of revenues. Meters should be tested every 5-10 years, or anytime a customer has a complaint regarding the meter. Residential meters should have an accuracy of between 98.5 – 101.5% or 100% +/- 1.5%. Larger meters can have a wider accuracy range, but normally not more than +/- 4%.

## POSITIVE DISPLACEMENT METERS

The positive displacement meter is the most common meter used in a water system. It is the meter used for residences and commercial services up to 2 inches. The most common types of positive displacement meter are the nutating disk and oscillating piston meters. Small multi-jet or turbine meters can also be used in these applications.



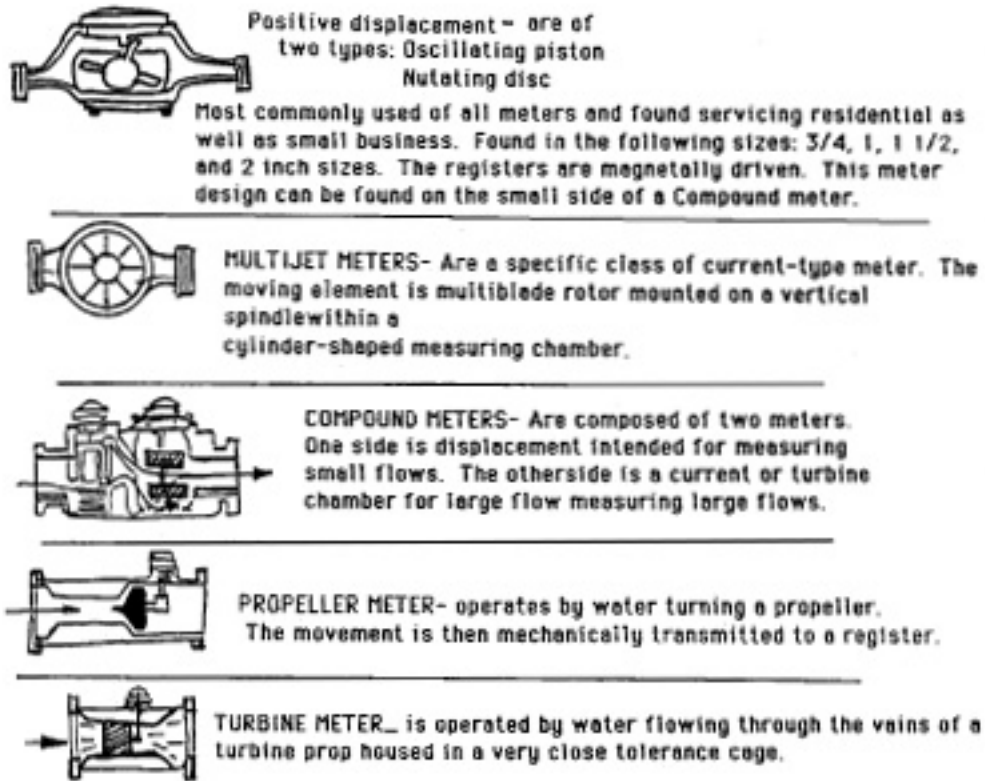

Figure 7.20 - Types of Meters

The positive displacement meter contains a measuring chamber with a fitted disc or piston. Each time the chamber fills and empties a predetermined amount of water is displaced as the disc or piston makes one rotation. The action of the nutating disc or the piston is transferred to the meter head by the use of gears or magnetic drives.

#### TURBINE/CURRENT METERS

This meter is designed so that water flowing through the meter chamber spins a close tolerance turbine or rotor. Propeller meters are used in large low pressure transmission lines. As the velocity of the water increases the speed of the rotor/propeller/turbine increases. The motion is transferred through a shaft to the meter register. In the past turbine meters were used only for high flows and were considered to be inaccurate at low flows. Small rotor-type meters are called multi-jet meters. These meters have been improved over recent years and are now available in sizes 5/8 inch and up. These are very dependable meters and have relatively low loss of head

#### VENTURI METERS

Venturi meters are used to measure high flows such as the intake from rivers or lakes and the discharge from wells. This type of meter usually consists of an upstream reducer, a short throat piece, and a long downstream section to increase the meter back to normal pipe size. The area the water flows through is reduced and the difference in head pressure is measured at the throat of the meter and just before the upstream reducer. Venturi meters are very dependable and with reasonable care will work for many years without adjustment.

#### READING METERS

A system should get an accurate reading of each meter each month. Most systems have an employee read the meters. Some have the customers reading their own meters. If the customers read their meters, a system representative should check the meters at least twice a year.

Most meters will have a circular register face or a dial face with a totalizer similar to a car odometer. The circular register faces are the more difficult of the two to read. To read this type of meter, start with the scale with the highest number (10,000,000) and then read each of the lower scales

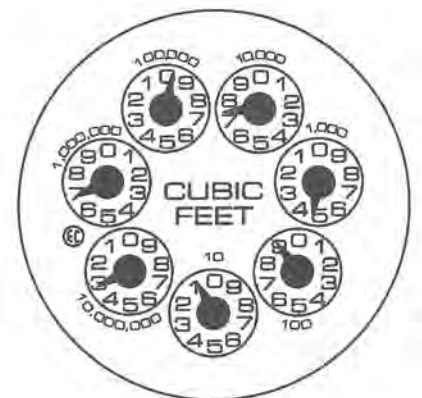

Figure 7.21 - Water Meter Dial

until you read the last scale (10.) When the hand is between two numbers record the lower number. If the hand is directly on a number, look at the next scale to see if it is in front of or behind the "0". The reading for the meter dial shown here is 2,697,490 cu.ft.

A water loss of less than 10% is considered acceptable and usually will not substantially increase the financial stress on the system. A loss between 10 15% signals that some

improvement is needed and spare time should be spent looking for the loss. Between 15 20% indicates that the problem is becoming serious and time should be set aside to search for the cause.

**Table 7.3 - Lost Water**

REASONS FOR LOST WATER
<ul style="list-style-type: none"> <li>• Non working or inaccurate meters</li> <li>• Leaks</li> <li>• Illegal taps</li> <li>• Storage tank overflowing</li> </ul>

**DISTRIBUTION SYSTEM HYDRAULICS**

There are a number of issues related the dynamics of moving water through a distribution system. The pressures in the system are determined by how high water is stacked in the air when conditions are static. But when water begins to move through the system hydraulic factors can affect pressures, flow, and forces exerted against the piping.

**FRICITION LOSS**

When water flows through a pipe a certain amount of energy must be expended to overcome the friction between the water and the surface of the pipe. The determination of the friction loss in a water line is dependent on four factors: A certain amount of friction loss results from any flow through any size or type of pipe, and this loss must be overcome, usually by increasing the pumping pressure, in order to maintain a given flow through the pipe. As metal lines get older their inner surfaces get rougher and the “C” Factor increases. Friction losses may be reduced by pigging the lines to remove scale or tuberculation caused by chemical stability problems.

**WATER HAMMER**

When water, that is moving through a water line, is suddenly stopped a pressure surge will be created in the line. This occurrence is known as a “water hammer.” The faster the water movement is stopped the greater pressure surge, or water hammer, will be. Water hammer can create a pressure surge up to 120 psi greater than the system pressure. Severe water hammer can cause ruptured lines and even lift water hydrants out of the ground. Once water hammer has been created it will travel down the line at a speed of about 760 mph.

**Table 7.4 - Friction Loss**

FRICITION LOSS FACTORS
<ul style="list-style-type: none"> <li>• Pipe length</li> <li>• Pipe diameter</li> <li>• Flow through the pipe</li> <li>• Coefficient of friction -”C” factor</li> </ul>

To minimize the effect of water hammer all valves and hy-drants in the system must be opened and closed slowly. Hydrau-lically operated check valves known as pump control valves also help to protect the pump and reduce water hammer. All bends and fittings on water mains should be backed by thrust blocks to protect them.

**THRUST AT PIPE BENDS**

Wherever a bend, elbow, tee, or dead end exists in a pipe-line having flexible joints, a force is exerted which tends to open the joints nearest the fittings. The magnitude of this force varies with the amount of bend, the diameter of pipe, and the pressure inside the pipe. When determining the resultant thrust for a given pipe it is advisable to use the maximum working pressure anticipated in the pipe plus an allowance for surges or water hammer.

Once the resultant thrust has been determined for a par-ticular bend, it becomes necessary to provide a backing block of such size to resist the thrust. The thrust must ultimately be borne by the side of the pipe trench and the surrounding soil. The purpose of the backing block is to spread the thrust over an area sufficiently large that the undis-turbed earth can support it. The supporting strength of most solid clay soils should vary between 1,500 and 4,000 pounds per square foot. Sandy soils may not support 1000 pounds per square foot.

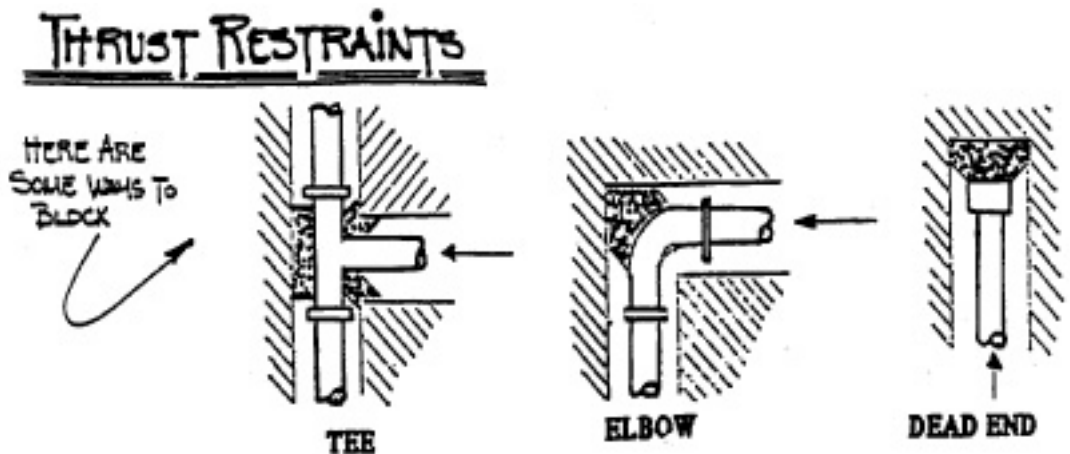

**Figure 7.22 - Thrust Restraints**

## CORROSION CONTROL

Corrosion can be a major cause of damage to a distribution system and the test to determine the stability of the water going to the public may be the most important operational tests a system operator can run.

### CORROSIVE WATER/CHEMICAL STABILITY

Water that is corrosive will attack all of the metal components of the distribution system including storage tanks, pipe, valves and meters. It will cause rust and tuberculation in iron pipe and steel storage tanks. Tuberculation can dramatically increase the friction loss and reduce the carrying capacity of a distribution line. Corrosive water can also result in problems from lead and copper that can leach out of the customers plumbing fixtures. Brass is 7-11% lead.

Carbon dioxide ( $\text{CO}_2$ ) dissolved in water will react to form carbonic acid ( $\text{H}_2\text{CO}_3$ ) which can cause corrosion. Dissolved oxygen or D.O. in water can also cause corrosion problems, especially if the alkalinity is low. Water can also be corrosive if the proper relationship between the pH and the alkalinity of the water does not exist. The Baylis Curve and the Calcium Carbonate Stability Test (Marble Test) are two of the methods used to determine the chemical stability of water.

### BAYLIS CURVE

One method of determining whether the pH and alkalinity are properly adjusted to produce stable, non corrosive water is with the Baylis Curve. Plotting the pH and alkalinity of the water on this chart will indicate whether the water is

corrosive or not. If the point where the pH and alkalinity cross is below the curve (dark gray area) the water is corrosive and will attack metal tanks and pipes in the system. If the point is above the curve the water is not corrosive but does have excessive amounts of alkalinity present, which will cause the formation of line scale in the lines. This scale formation can restrict the flow of water in the line if allowed to build up over a long period of time and can be as bad for the system as corrosive water. When the point falls within the dotted lines or on the curve itself, the water is stable and will not cause corrosion problems.

### GALVANIC CORROSION

Whenever two dissimilar metals come in contact and are submerged in water, an electric current is generated. This type of reaction occurs in most storage batteries. It also occurs in a water system where different kinds of metal components are used, such as meter installations and service connections and couplings.

When these conditions exist, the electric current that is generated will pass from one metal surface to the other. Metal from one side of the connection will be plated onto the other side. This will eventually cause a piping failure as the threads of one side are plated on the other.

### ELECTROLYSIS

When D.C. electric current enters a metal pipe, it runs down the pipe and, at some point, discharges into the ground. The passage of this current from the pipe into the ground will cause metal in the pipe to be plated into the surrounding soil. This type of corrosion is known as electrolysis.

**Relation Between pH Values and Alkalinity**

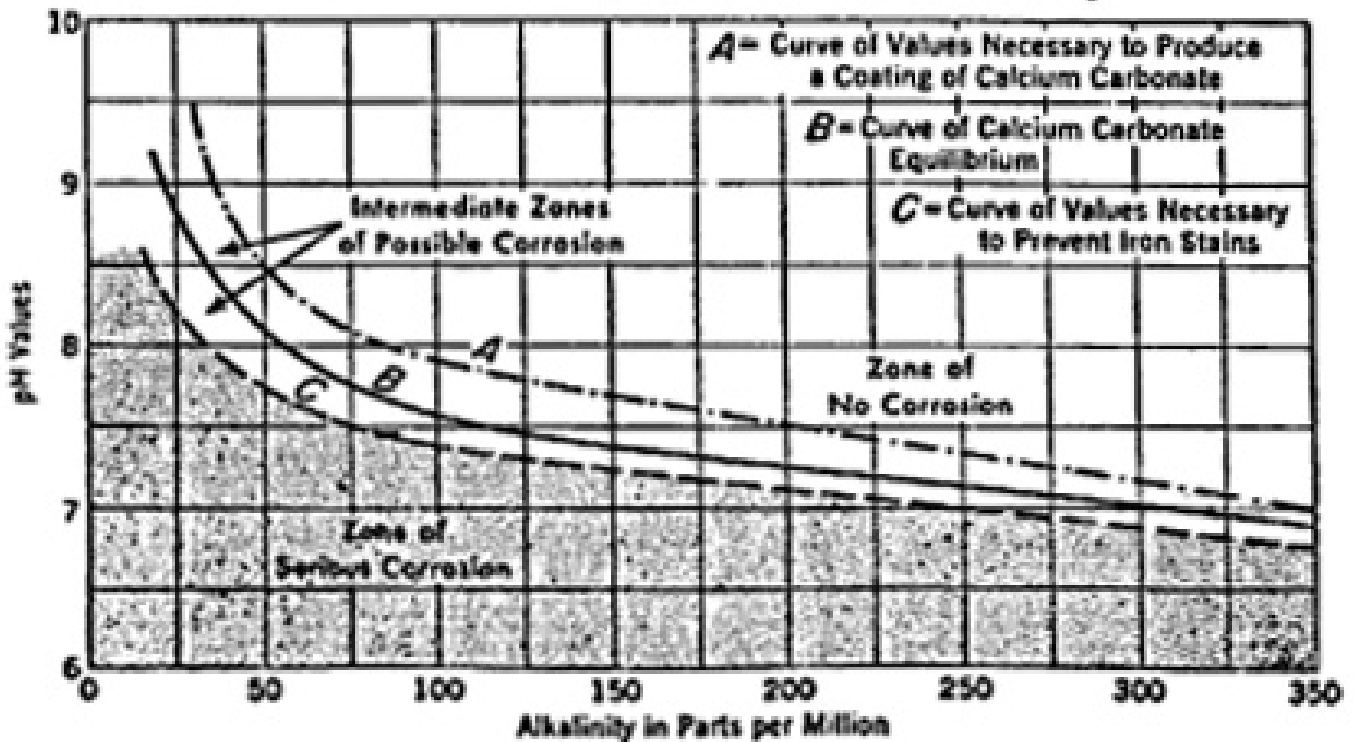

Figure 7.23 - Baylis Curve

Any D.C. current machinery or telemetry equipment that is grounded to water lines will cause electrolysis. However, A.C. current, such as household current, can be grounded to water lines without causing electrolysis since alternating current will not plate the metal into the soil. The use of plastic pipe will eliminate electrolysis problems since plastic is a non conductor.

### CORROSIVE SOIL

Metal pipe that is laid in highly acid soils may also encounter serious corrosion problems from the outside as well as the inside. If cast iron or ductile iron pipe is to be laid in corrosive soil it should be coated with tar or other protective coating to prevent it from being damaged.

### CROSS-CONNECTION CONTROL

The plumbing at schools, water treatment plants, wastewater plants and other public and private facilities can be so complicated that the potable water piping can be unintentionally connected to a source of contamination. If this happens, a health risk is created. There are hundreds of incidents each year where contaminated material enters a water system through cross-connections.

In small communities possible sources of contamination are associated with swimming pools and wastewater treatment plants where chemicals such as chlorine, fluoride and boiler additives are used.

A health risk would exist if the drinking water system were connected directly or indirectly to contaminated sources. This could happen when you are mixing a chemical and you place the hose in the mixing tank or connect the drinking water system to the **seal water**<sup>5</sup> supply on a sewage pump. This direct or indirect connection is called a **cross connection**<sup>6</sup>.

### BACKFLOW

The cross-connection can only cause a problem if there is a reversal of flow in the system.

This reversal of flow is called backflow. Backflow exists anytime water moves backward through the system.

### Backsiphonage

There are two ways that backflow can occur; backsiphonage and backpressure. Backsiphonage occurs when the pressure in the system drops below atmospheric pressure and the water distribution system is connected to a nonpotable source that is open to the atmosphere. This could happen if the distribution system pressure were lowered as a result of a break or heavy use, such as during a fire.

### Backpressure

Backpressure exists any time the pressure in the contaminated source exceeds the pressure in the distribution system. Backpressure could happen as a result of a booster pump in a heating system or excessive pressures in a boiler that is improperly connected to the potable water supply.

Failure of the check valve would allow boiler feed chemicals to enter the drinking water system. This could occur if the boiler pressure were greater than the water system pressure or if there was a drop in the water system pressure from a broken line.

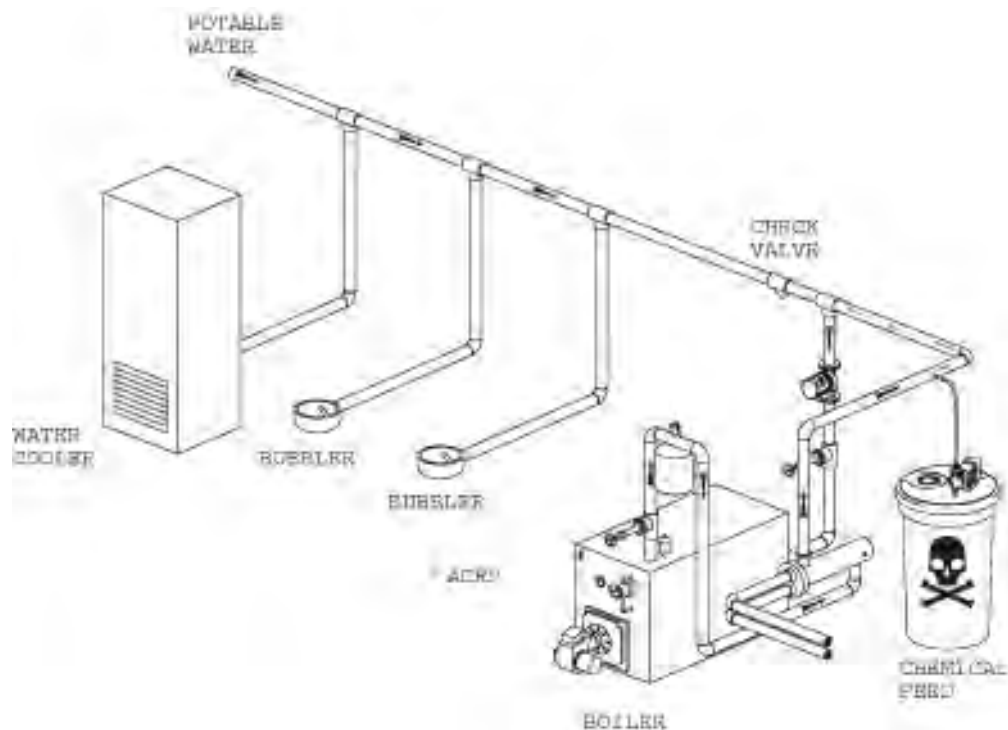

Figure 7.24 - Backpressure with boilers

<sup>5</sup> **Seal Water** - The water supplied to the stuffing box to lubricate and flush the packing or the mechanical seal.

<sup>6</sup> **Cross-Connection** - Any physical arrangement whereby a public water supply is connected, directly or indirectly, with a non-potable or unapproved water supply or system.

## Prevention

Each state's drinking water regulations indicate that a known cross-connection cannot be allowed to exist. Because inspection of facilities is difficult, time-consuming and not always possible, the waterworks industry has taken a preventive approach to cross-connection control. Under this approach, facilities that have a high potential of cross-connection or handle highly hazardous materials are required to protect the water system. This is accomplished by installing special devices in the facility and on the water service connection where it enters the facility.

## Devices

The devices used to prevent backflow from a potential cross-connection are:

- Air gaps
- Atmospheric vacuum breakers
- Pressure vacuum breakers
- **Double check**<sup>7</sup> valve assemblies
- Reduced pressure backflow prevention device assemblies

## Selection of Devices

The device to be used is selected on the basis of the degree of hazard, plumbing arrangement in the facility and the use of additional devices within the facility.

## Degree of Hazard

A high hazard facility would include a sewage treatment plant or lift station. A low level of hazard would be a situation where the odor and taste of the water might be affected but there is no health risk.

## **BACKFLOW PREVENTION DEVICES**

### Air Gap

The most protective of the devices is the **air gap**<sup>8</sup>. The air gap is easy to observe and inspect. The air gap is a positive way to protect the water supply from a chemical vat. The requirements

are that the air gap between the two water sources be twice the diameter of the outlet of the supply line or a minimum of 1 inch from the rim of the tank. Air gaps can be used on high hazard conditions.

### Atmospheric Vacuum Breaker

Atmospheric vacuum breakers are used on low degree hazard conditions such as janitor sinks, lawn sprinkler systems, and supply lines on low concentration chemical vats, such as chlorine and fluoride solutions. Atmospheric vacuum breakers open any time there is a backsiphonage and allow air to be drawn into the line, preventing a backflow of the downstream solution. They will not prevent backflow

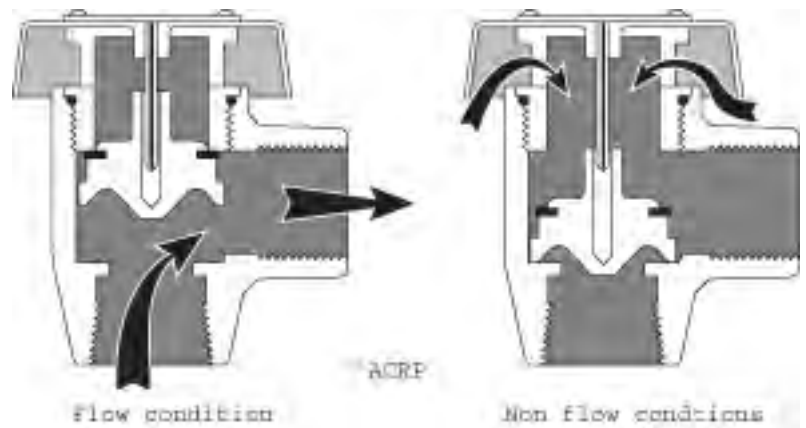

**Figure 7.26 - Atmospheric vacuum breaker**

as a result of backpressure. A downstream valve cannot be installed on an atmospheric **vacuum breaker**<sup>9</sup>.



**Figure 7.25 - Air Gap**

### Pressure Vacuum Breakers

Pressure vacuum breakers are used for the same functions as an atmospheric vacuum breaker. There are only three differences. The pressure vacuum breaker has an internal spring that helps it open, there are valves to allow the device to be tested, and a valve can be placed in the downstream line.

<sup>7</sup> **Double Check Valve Assembly**- An assembly of two independently acting check valves with shut-off valves on each side of the check valves and test ports for checking the water tightness of each check valve.

<sup>8</sup> **Air Gap** - A positive means of preventing a cross-connection. An air gap should be twice the diameter of the discharge pipe or a minimum of 1 inch above the rim of the tank.

<sup>9</sup> **Vacuum Breaker** - A mechanical device that prevents backflow due to siphoning action created by a partial vacuum that allows air into the piping system, breaking the vacuum.

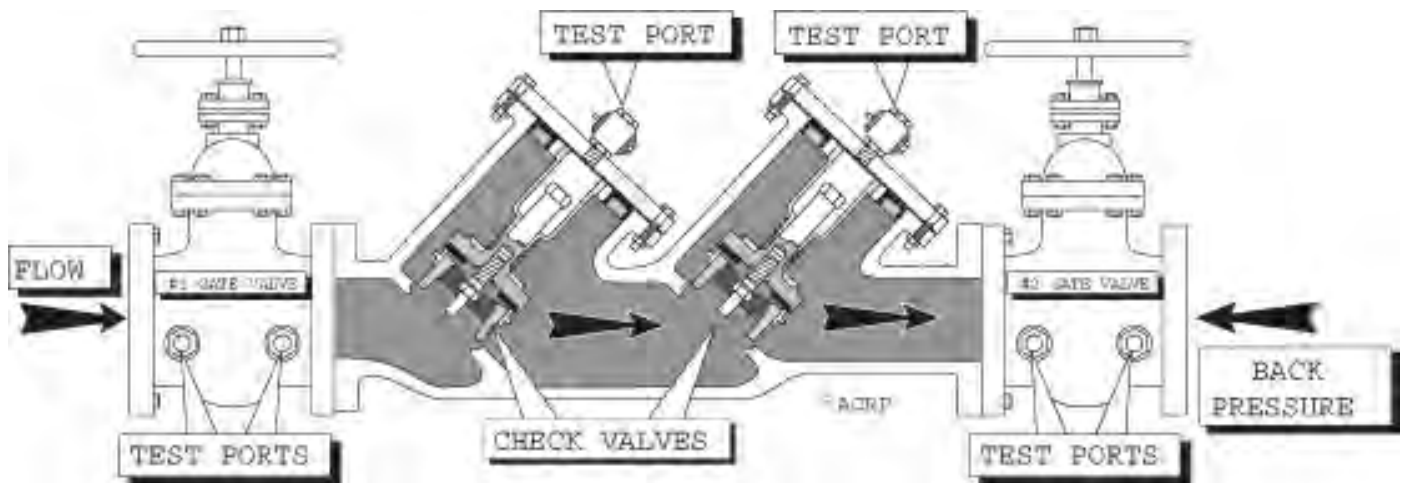

Figure 7.27 - Double Check Valve

### Double Check Valve Assemblies

A double check valve assembly (DCVA) is composed of two independent internally weighted check valves (springs), isolation valves on each side of the assembly and test ports on the assembly that allow a tester to determine that the check valves are watertight. DCVA will protect against backpressure or backsiphonage on low hazard conditions.

### Reduced Pressure Device

High hazard conditions require an air gap or a reduced pressure zone backflow prevention device (RPZ<sup>10</sup>). It is composed of two independent, internally weighted check valves separated by a reduced pressure zone which is valved to the atmosphere. The assembly also has an isolation valve on each end as well as test ports to determine the proper operation of the assembly. The valve is designed so that the valve on the reduced pressure zone will open anytime the pressure in the zone gets to within 2 psi of the supply pressure. In order for backflow to occur through this valve, the two check valves as well as the reduced pressure zone valve would have to fail at the same time.

### Selection of Devices

Only approved devices may be installed in a water system. In order for a device to be approved it must undergo extensive testing by a private testing laboratory. Most state regulatory agencies maintain a list of approved devices

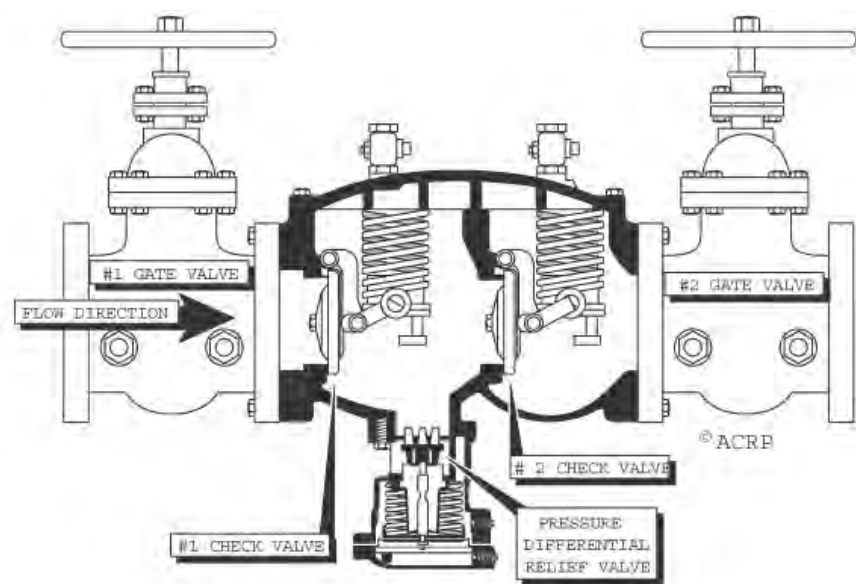

Figure 7.28 - RPZ Device

### Testing Device

The devices must be tested once each year by a certified backflow prevention device tester. In order to obtain a certification as a backflow prevention device tester you must attend a school and pass a written and practical exam. In order to maintain your certification some states require an annual refresher course, proof that you have tested devices in the past year and a certificate indicating that your test instruments have been tested within the past year.

### References

- ACR Publications, Inc., Skeet Arasmith, *Introduction to Small Water Systems*, Chapter 5
- Office of Water Programs, California State University, Sacramento, *Water Distribution System O&M*, 4<sup>th</sup> ed., Chapters 3, 5, 6 & 8.

<sup>10</sup> RPZ - Reduced Pressure Zone Backflow Prevention Device - A backflow prevention assembly containing two check valves, a differential relief valve located between the two check valves, shut-off valves on each end of the assembly and test ports for checking the water tightness of the check valves and the operation of the relief valve.

### **BASIC STUDY QUESTIONS**

1. Which type of pipe is not affected by corrosive water?
2. What is the most common type of residential meter?
3. What type of valve is a corporation stop?
4. What are the two types of fire hydrants?
5. What should be done before you excavate to make a repair?

### **BASIC SAMPLE TEST QUESTIONS**

1. At what percentage does unaccounted-for water become excessive?
  - A. 5%
  - B. 10%
  - C. 20%
  - D. 30%
2. A corporation stop will be located:
  - A. Where the service is attached to the main
  - B. Between the main and the meter
  - C. At the meter yoke
  - D. On the customer's side of the meter
3. Which type of valve is best suited for throttling flows?
  - A. Gate Valve
  - B. Butterfly Valve
  - C. Check Valve
  - D. Air relief Valve
4. When a meter gets worn it will always over register and record water that wasn't used.
  - A. True
  - B. False
5. Water hammer is caused by:
  - A. Opening a valve too slowly
  - B. Closing a valve too quickly
  - C. Excessive hardness
  - D. High pressure on the suction side of a pump

### **ADVANCED STUDY QUESTIONS**

1. How is a compound meter different from other meters?
2. What is the procedure for disinfecting water lines?
3. Why should you never throttle the flow using the hydrant valve on a dry-barrel hydrant?
4. What are two means of determining the chemical stability of water?
5. What is tuberculation?

### **ADVANCED SAMPLE TEST QUESTIONS**

1. The best way to protect the water supply from contamination by cross-connection is:
  - A. A double check valve
  - B. A vacuum breaker
  - C. An air gap
  - D. A reduced pressure zone device
2. The positive side of the cathodic protection system is the:
  - A. Tank
  - B. Cathode
  - C. Rectifier
  - D. Sacrificial anode
3. A flow meter on a fire line would probably be a:
  - A. Venturi meter
  - B. Nutating disk meter
  - C. Oscillating piston meter
  - D. Compound meter
4. When filling a main, the water velocity should never exceed:
  - A. 1 ft/sec
  - B. 2.5 ft/sec
  - C. 10 ft/sec
  - D. 20 ft/sec
5. When two storage tanks that serve the same area have different overflow elevations, what type of valve should be included on the lower tank?
  - A. Check valve
  - B. Altitude valve
  - C. Air relief valve
  - D. Ball valve

BLANK PAGE



## CHAPTER 8: WATER STORAGE

---

### WATER STORAGE

Adequate ground and elevated storage tanks are essential for the proper operation of a water system. These tanks are necessary to provide an ample supply of water during peak demands, dependable fire protection with lower insurance rates, adequate water pressure to outlying areas, and lower pumping costs. Elevated storage tanks are said to “float” on the system. This means that they hold large volumes of water high enough in the air to supply the system with water at usable pressures during peak demands. To maintain a static pressure of 50 psi, water must be stored 115 feet above the customer.

The type and size of a storage tank to be used depends on the desired operating main pressure and the highest daily peak demand. Ground elevations in the area should be surveyed and the storage tanks located at the highest possible elevation to the area served. Ample storage capacity in a water distribution system will mean lower operating costs and fewer pressure problems for the operator.

### GROUND STORAGE TANKS

The purpose of ground storage is to hold enough water in reserve to compensate for fluctuation of the water demand in the system. The most common location of ground storage tanks is near the well field or treatment plant. These storage tanks are usually referred to as clear wells. Clear wells are also used to store additional water, which can be pumped into the system for fire fighting purposes.

### CONSTRUCTION OF GROUND STORAGE TANKS

Ground storage tanks are constructed of reinforced concrete, pre-stressed concrete, and steel. Reinforced or pre-stressed concrete is the preferred material since it does not deteriorate in contact with water. Concrete requires little maintenance and can help minimize rust scale in corrosive water. Concrete construction is more expensive than when steel is used. Steel is sometimes used when construction budgets are limited. The savings on the initial may be sufficient to justify the added expense of maintenance on the steel structure.

### DESIGN CAPACITIES OF GROUND STORAGE TANKS

A clear well should provide storage equivalent to at least 4 to 6 hours supply at peak daily flow (2.5 times daily average). This amount will usually permit a uniform pumping rate throughout the day. Clear wells should also contain additional storage for filter backwash water. Plants that operate on a part time basis may require additional clear well capacity to meet these peak flow demands. This storage capacity may range from several thousand gallons in small rural systems to several million gallons in very large ones.

### LOCATION OF GROUND STORAGE

Some ground storage tanks are built above ground while others may be partial or completely underground. Underground storage should be located above the local ground water table. All tanks should be located so that surface and underground drainage is away from the structure. Tanks should never be located within the 100-year flood plain. Sewer lines within 50 feet of the tank must be watertight cast iron.

### PROTECTION OF GROUND STORAGE TANKS

Provisions must be made to insure that sunlight, rain, winds, bugs, and people do not enter the tank. This will prevent possible contamination of the supply from outside sources.

- Vents and overflows should be pointed down to exclude sunlight and rainwater. Sunlight will cause algae to grow, which may result in customer complaints.
- Vents and overflows should have a fine mesh screen cover to prevent the entrance of birds and insects. Some gnats lay eggs in water that hatch into “bloodworms”. These are harmless, but their presence in water will always bring customer complaints.
- Manholes should be extended above roof levels. They should be fitted with a watertight cover that should be locked except when working in the tank.

### FIRE PROTECTION

In some cases, elevated storage tanks are located near the center of high value districts in order to provide greater protection from fire loss in these areas. Standards set up by the Fire Insurance Commission must be met to receive credit in establishing fire insurance rates. The minimum storage for fire protection, should be 60 gallons per capita per 24 hours, or at least 50,000 gallons per day. This quantity of water plus the amount needed should satisfy daily peak demands must be available in storage.

### CATHODIC PROTECTION

When two dissimilar metal rods are connected to a voltage meter and submerged in water that contains dissolved salts, a very small voltage reading (less than 0.0001 volts) will occur. This is the way electric storage batteries work. In an elevated storage tank the impurities in the water and the tank itself can cause a voltage to be generated, with the tank giving up metal as the current flows into the surrounding water and to ground.

Cathodic protection systems can be installed to prevent this corrosion by reversing the flow of the electrical current from the water to the tank. The basic theory of cathodic protection is to supply current, from an outside source, through sacrificial anodes suspended in the tank and back into the tank. This electrical current is D.C. and the voltage should be just enough to compensate for the natural voltage

set up between the tank and the water. The tank is now the ground and will not become pitted.

The sacrificial anode is usually a piece of iron, magnesium, carbon, or aluminum that is 1-2 inches in diameter and 12 to 18 inches long. The anodes are designed to give up metal to the water instead of the tank. Therefore, they will eventually need replacing. They should be inspected every six months and usually replaced yearly. Installation and maintenance of a cathodic protection system can be hazardous work and should be done by a professional tank and tower company. The success of an installation depends on the proper spacing of the anodes so that all surfaces of the tank receive the flow of current equally. When cathodic systems run at too high a voltage, above 1.2v on a test cell, hydrogen gas can be generated between the tank and any coating material. This can result in blistering and peeling of the coating, which can also cause corrosion.

#### LEVEL INDICATORS

Automatic pump controls are operated by signals from the storage tank that indicate that the water is at the lowest or highest desired level. A signal from the low-level indicator will start the pump. The pump will continue to run until the water fills the tank up to the high level. A signal will then go back to the pump to shut it off. There are three main types of liquid level control systems. They are electrode systems, float systems, and pressure sensing systems.

#### ELECTRODE SYSTEMS

The use of electrodes is the most common system used today. Pump controls are activated as the water level rises above or drops below these electrodes. As the water level drops below the low-level electrode, the circuit is opened triggering a control signal to start the pump. As the water level rises to contact the high level electrode the circuit is closed triggering a control signal to shut off the pumps. The pump will not restart until the water level drops below the low-level electrode again.

#### FLOAT SYSTEMS

Float systems are used primarily in ground storage tanks. As the float rises or falls with the water level, high level or low level switches are tripped activating the pump control circuit. This type of level control will have to be checked on a regular basis to prevent malfunctions. Freezing during the winter is always a problem with floats and electrodes due to damage caused as the water level (and the ice) rises

and falls. Circulation of water inside the tank may help minimize ice buildup.

#### PRESSURE SENSING SYSTEMS

Pressure sensing controls are normally located near the bottom of the storage tank. This type of control is activated by the amount of head pressure in the tank. As the pressure increases, a spring or metal band is expanded tripping a

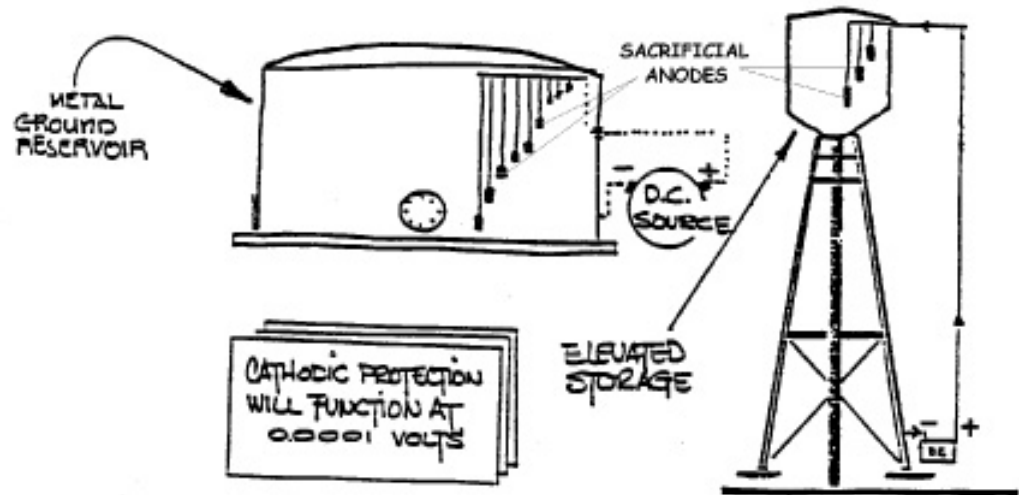

Figure 8.1 - Sacrificial Anodes Used for Cathodic Protection

microswitch or a mercury switch that then activates the pump. The on and off levels on these switches are set by applying or decreasing the tension on the spring, or by setting manual control points on a dial for the mercury switch. These switches must be protected from freezing and extreme vibrations for proper operation. Pressure transmitters can also be used to control multiple wells or pumps and the signal can be converted into a tank level reading.

#### HYDROPNEUMATIC STORAGE

Very small water systems may find that elevated storage tanks are too expensive and, in some types of terrain, very difficult to install. They must resort to other means of supplying pressure to the customer. One way to do this would be to run a pump continuously to pressurize a closed system. This is sometimes referred to as a deadhead condition. Without some special control valving and bypass piping, this could result in the pump running against shutoff head much of the time and cause the pump to overheat. It also limits consumption to the rated flow of the pump.

Hydropneumatic storage tanks are pressurized by a surcharge of air that forms a bubble in the tank. They can be used to pressurize the system and provide storage. The storage capacity keeps the pump from cycling off and on every time a faucet opens. Pneumatic tanks are also used in large systems as surge protection systems. As the pressure from a water hammer surge enters the tank, the force is exerted against the air pocket. The air pocket is compressed and absorbs the energy to dampen the shock wave.

## TYPES OF PNEUMATIC TANKS

Pneumatic storage tanks are available in several designs. They all look the same from the outside. The difference is how the air pocket inside is controlled. The plain steel tank simply has an air bubble in it. There is nothing to separate the air from the water. The advantage of this tank is that air that may be in the water can be separated in the tank. The disadvantage is that air is being continuously dissolved in the water absorbed, so the bubble will shrink over time. This means that air must be introduced into the tank periodically. Some wells have a special snifter valve on the discharge line that injects a small amount of air into the line as the pump runs. Since this may put too much air in the tank, a relief valve acts as a level control to keep the proper volume of air in the tank.

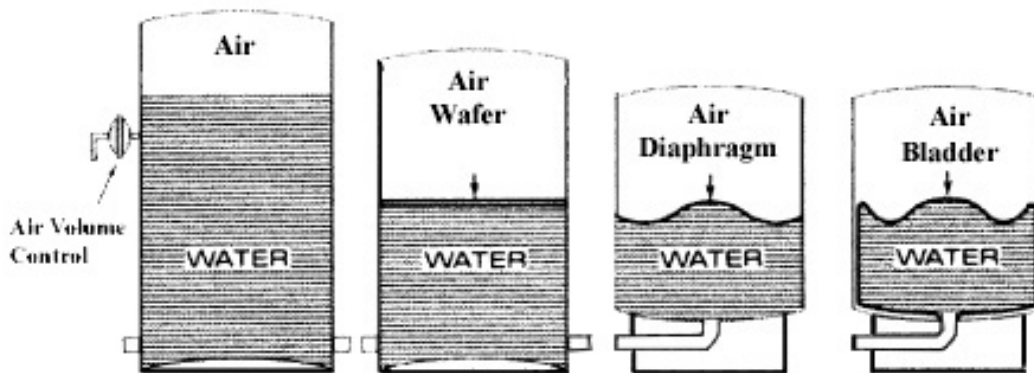

Figure 8.2 - Types of Pneumatic Tanks

The other types of pneumatic tanks have a barrier between the air and water to minimize or eliminate the amount of air lost of absorption. Wafers and diaphragms separate the water from the air, but a bladder design also prevents the water from coming in direct contact with the sides of the tank. This can help prevent corrosion from soft, low alkalinity water. The wafer, diaphragm, and bladder designs require air charging from an external source. Air compressors tied to level switches automatically maintain the proper air volume in large tanks. Smaller tanks should be checked regularly and charged with portable air compressors or air tanks. If the air pocket does disappear, the tank will be full of water and the pump will begins to cycle more often since there will be no drawdown in the tank.

## SIZING A PNEUMATIC SYSTEM

The capacity of a pneumatic tank is the drawdown. The drawdown is the difference in water levels from the point where the pump cuts in to the point where it cuts out. The general rule for sizing a pneumatic tank is that the drawdown

in the tank should equal at least two minutes of the pump's rated flow. For example, if a well produces 30 gallons per minute, the drawdown should be at least 60 gallons. This means that the pump will always run for at least two minutes each time it cycles on and off. This will greatly reduce the impact that cycling has on the pump.

The pump will actually get a start signal from a pressure switch rather than a level indicator. The pressure switch will normally be set to start at 40 psi and stop at 60 psi, although some very small systems may run from 20-40psi. The equipment supplier can calculate what this would mean in terms of gallons of drawdown for a new tank. For an existing tank, just isolate the tank at shutoff pressure and see how much water drains out to drop the pressure to the cut in point.

Elevated storage tanks are located in areas that have pressure problems due to small lines or long runs of piping. Pneumatic tanks can also be moved out into the system where pressure problems exist. It will also increase the amount of in storage for the system. Pneumatically pressurized systems provide no fire protection since there is not enough water available at pressure.

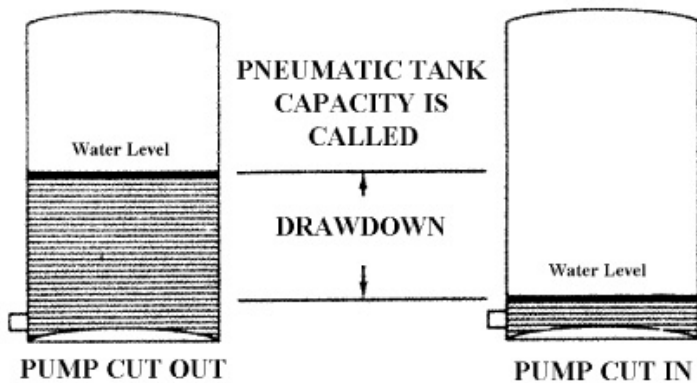

Figure 8.3 - Drawdown

## References

- Office of Water Programs, California State University, Sacramento, *Water Distribution System O&M*, 4<sup>th</sup> ed., Chapter 2.
- Office of Water Programs, California State University, Sacramento, *Small Water System O&M*, 4<sup>th</sup> ed., Chapter 3

## **BASIC STUDY QUESTIONS**

1. Where would you find an air gap on a ground storage tank?
2. What does cathodic protection do?
3. What are sacrificial anodes?
4. What is the drawdown in a pneumatic storage tank?

## **BASIC SAMPLE TEST QUESTIONS**

1. All vents and overflows on a storage tank should be screened.
  - A. True
  - B. False
2. Pneumatic storage tanks must be full of water to work properly.
  - A. True
  - B. False



## **ADVANCED STUDY QUESTIONS**

1. Which types of storage tanks are more likely to have corrosion problems?
2. What are three ways to control the water level in a storage tank?
3. Why is ice a problem in the winter?

## **ADVANCED SAMPLE TEST QUESTIONS**

1. What type of electrical current is used in cathodic protection?
  - A. AC current
  - B. DC current
  - C. 3-phase current
  - D. Synchronous current
2. What is likely to grow in a storage tank that is not covered?
  - A. Sulphur bacteria
  - B. Algae
  - C. Trout

## CHAPTER 9: PUMPS & MOTORS

Pumps provide the means for moving water through the system at usable working pressures. The operation and maintenance of these pumps are some of the most important duties for many water utility operators. There are two basic types of pumps used in water and wastewater systems. The most common type of pump is the centrifugal pump. The other type is the positive displacement pump.

All pumps are rated by the flow they produce and the pressure they must work against. Centrifugal pumps are used for high flow and low head pressure applications. Booster pumps or primary service pumps are required to move high volumes of water and usually operated at low head pressures (200-300 feet of head for water and as little as 50 feet of head for wastewater applications). Centrifugal pumps are ideally suited to these types of applications and are much more efficient than positive displacement pumps of comparable size. Positive displacement pumps are used for low flow and high-pressure applications. High pressure water jet systems like those used for well screen or sewer line cleaning use positive displacement pumps since pressure in excess of 2500 feet of head are needed and the flows seldom exceed 100 gpm. Sludge pumps and chemical feed pumps are also likely to be positive displacement pumps. Piston pumps, diaphragm pumps, and progressive cavity screw pumps are the most common types of positive displacement pumps.

Another difference between centrifugal and positive displacement pumps has to do with how they react to changes in discharge pressure. When the pressure that a centrifugal pump has to work against changes, the flow from the pump changes. As the pressure increases, the flow from the pump will decrease, and when the pressure drops the flow will increase. Positive displacement pumps do not react this way. The flow does not change when the discharge pressure changes. This is the main reason that positive displacement pumps are used for chemical feeding and sludge pumping. The operator knows that every time the pump strokes, it is pumping the same amount of fluid. This is important if accurate records are to be kept of

chemical dosages and pounds of solids that are moving through the system.

### CENTRIFUGAL PUMPS

A centrifugal pump moves water by the use of centrifugal force. Any time an object moves in a circular motion there is a force exerted against the object in the direction opposite the center of the circle. This would be easier to explain if we use an example of a person with a bucket full of water. If the person swings the bucket in a circle fast enough, the water will stay in the bucket even when it is upside down. The force that holds the water in the bucket is called centrifugal force. If a hole is made in the bottom of the

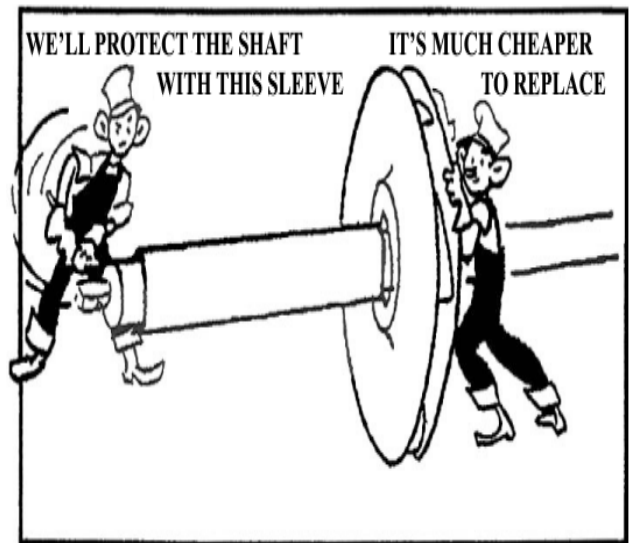

**Figure 9.1 - Impeller Rotation & Centrifugal Force**

bucket, and it is swung in a circular motion, the centrifugal force will push the water out of the bucket through the hole. The same principle applies when water is moved through a centrifugal pump.

**Table 9.1 - Pump Characteristics Overview**

<b>TYPE OF PUMP</b>	<b>PRESSURE/FLOW RATING</b>	<b>CHARACTERISTICS</b>
Centrifugal	Low Pressure/High Flow	Flow changes when pressure changes
Positive Displacement	High Pressure/Low Flow	Flow doesn't change when pressure changes

An impeller spins inside a centrifugal pump. It is the heart of the pump. Water enters the center, or suction eye, of the impeller. As the impeller rotates, the veins pick up the water and sling it out into the pump body under pressure. It is the pressure exerted by the vanes that moves the water out of the pump and into the system. The suction created as the water leaves the impeller draws more water into the impeller through the suction eye.

The number of vanes and the sweep of the veins determine the performance characteristics of the impeller. As vanes are added, the impeller will produce higher discharge pressures and lower flows. The same situation applies to increasing the length or sweep of the vanes. Reducing the number of vanes or the sweep of the vanes will increase the flow and reduce the pressure.

### TYPES OF CENTRIFUGAL PUMPS

There are three basic types of centrifugal pumps. Although they differ in design, all three have the same basic components. The first centrifugal pumps were called horizontal split case pumps. [See Figure 9.2] The shaft is horizontal and the casing is split in half. With the top half of the casing removed, the entire rotating assembly can be removed for maintenance. The problem with horizontal pumps is the floor space they require.

End suction centrifugal pumps were designed to take up less floor space. [See Figure 9.3] The suction piping enters at the end of the pump and discharges at a 90° angle to the suction. This allows more flexibility in installation and, since the pump can be mounted vertically, more pumps can be placed in a given floor space.

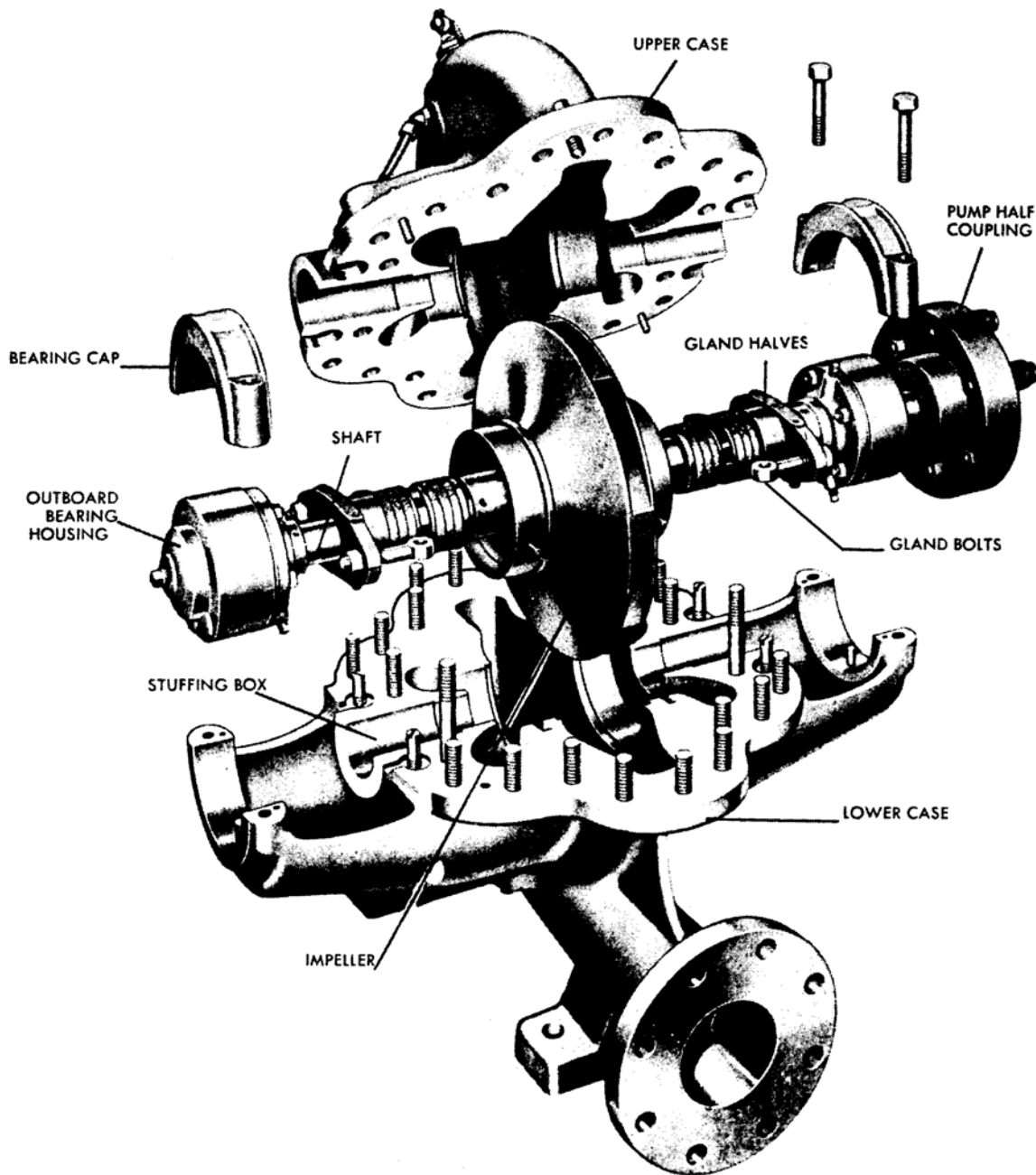

Figure 9.2 - Horizontal Split Case Centrifugal Pump

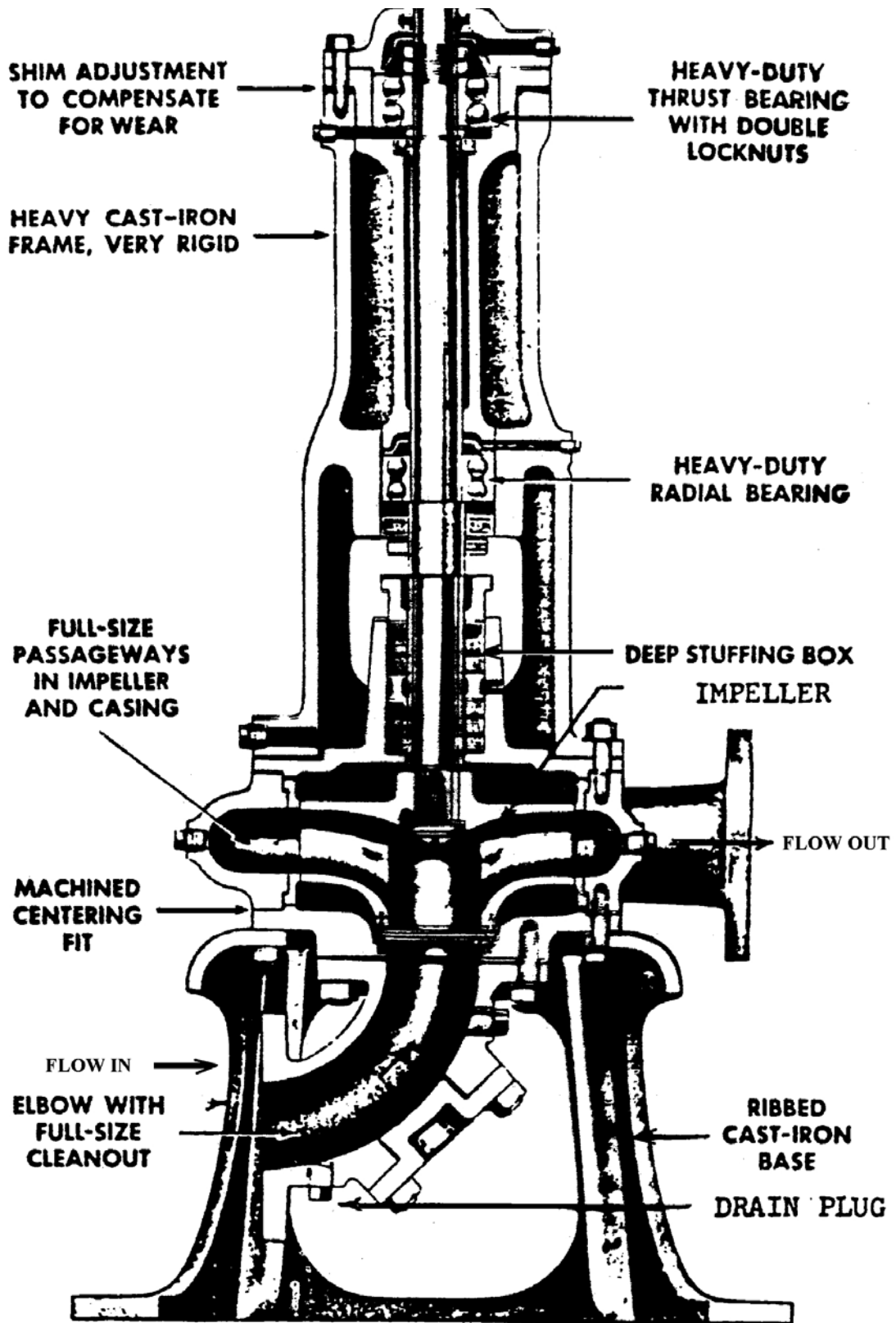

Figure 9.3 - End-Suction Centrifugal Pump

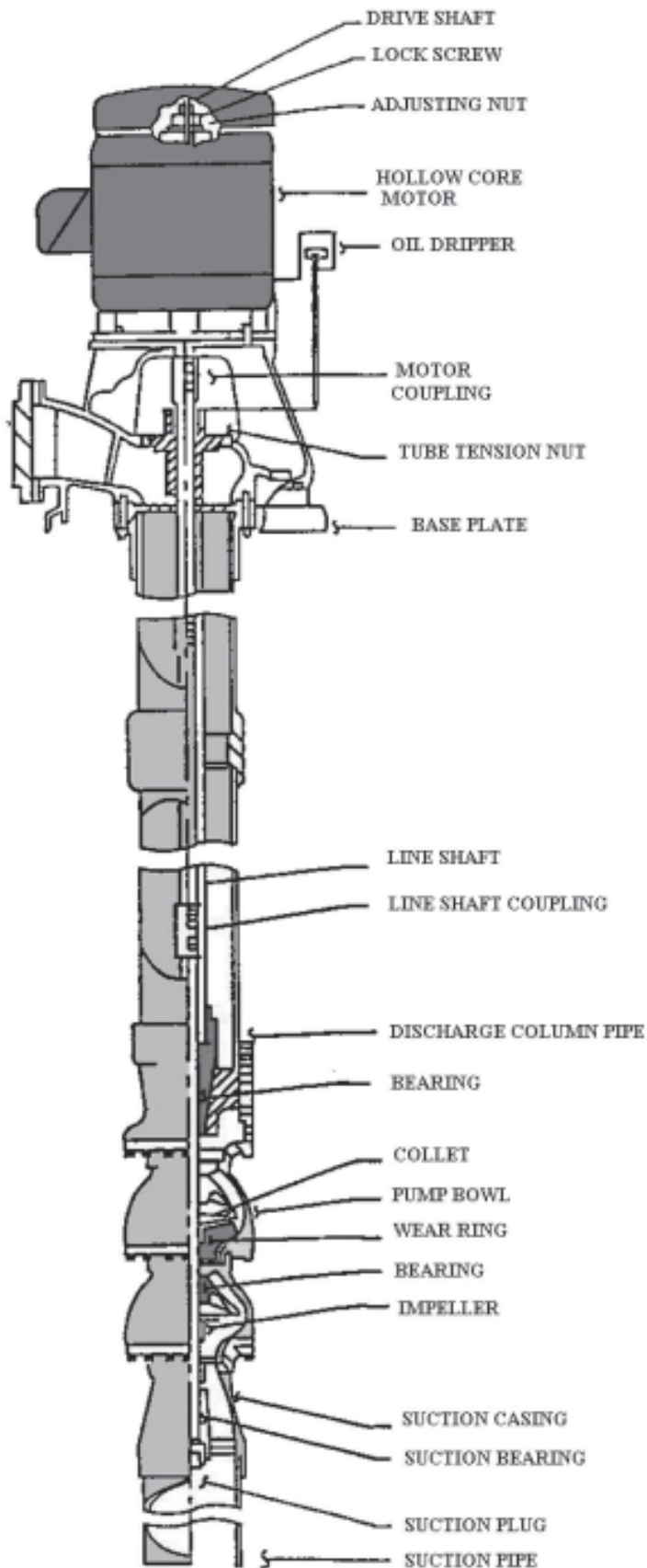

Figure 9.4 - Vertical Turbine Centrifugal Pump

A vertical turbine centrifugal pump consists of multiple impellers that are staged on a vertical shaft. [See Figure 9.4] The impellers are designed to bring water in the bottom and discharge it out the top. This results in axial flow as water is discharged up through the column pipe. Staging the impellers in these pumps can create very high discharge pressures, since the pressure increases as the water moves through each stage.

### CENTRIFUGAL PUMP COMPONENTS

Before we can discuss operation and maintenance of a centrifugal pump, it is important to understand how a pump is put together and what each pump component does. A centrifugal pump is constructed from about a dozen major components. Let's take a look at how these pieces fit together to make a pump.

The impeller is attached to the pump shaft. The shaft must be straight and true so that it will not cause vibration when it rotates. The shaft should be protected from potential damage caused by the failure of other pump parts. A shaft sleeve is used to protect the shaft in the area where the shaft passes through the pump casing.

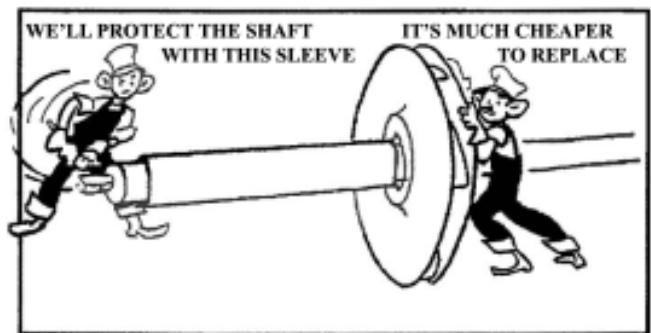

Figure 9.5 - Shaft Sleeve

This rotating assembly must be supported as it spins in the pump. Bearings hold the spinning shaft in place. There are two types of anti-friction bearings normally found in centrifugal pumps. One type of bearing is

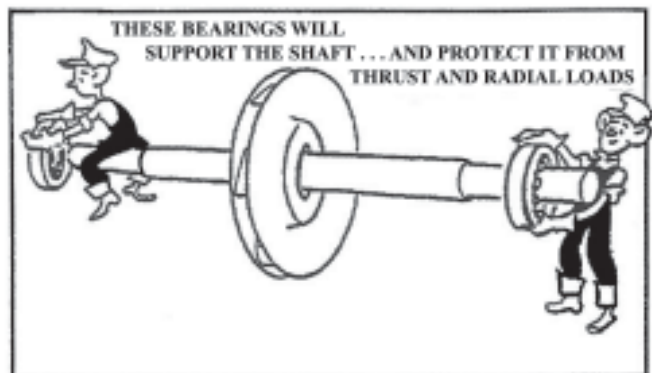

Figure 9.6 - Pump Bearings



designed to keep the shaft from wobbling from side-to-side as it spins. This side-to-side motion is referred to as radial movement. The bearings used to prevent radial movement of the shaft are called radial bearings. The most common variety of radial bearing is the standard ball-type roller bearing

As the impeller spins, water entering the suction eye pushes against the top of the impeller exerting force in the same axis as the pump shaft. This is referred to as upthrust. The pressure developed inside the pump also pushes against the impeller in the opposite direction. This downward force is referred to as downthrust. Bearings designed to support the shaft against this type of force are called thrust bearings. The most common variety of thrust bearing is an angular contact ball bearing.

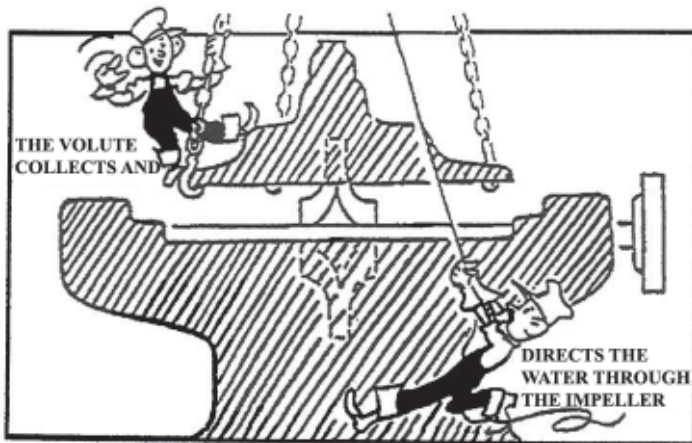

Figure 9.7 - The Volute

The rotating assembly is placed in a pump casing. Part of the pump casing is specially designed to collect and direct the flow of water as it enters and leaves the impeller. This part of the pump casing is called the volute.

The suction and discharge piping are attached to the pump casing. The suction piping will always be larger than the discharge piping. Suction piping is designed to bring water into the pump at 4 ft/sec in order to minimize the friction

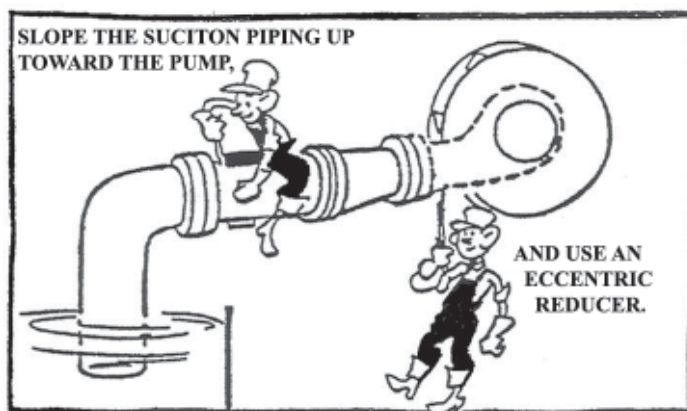

Figure 9.8 - Suction Piping

loss on the suction side of the pump. The discharge piping is designed to carry water away from the pump at 7 ft/sec. There are several important aspects to suction piping installation. Horizontal runs of piping should slope upward toward the pump. Any reducers on the line should be horizontal across the top instead of tapered. A reducer that is flat on one side is known as an eccentric reducer. A reducer that is tapered on both sides is called a concentric reducer.

These installation features are used to prevent the formation of air pockets in the suction piping. Air trapped in the suction piping can create restriction of flow into the pump. It is also important to make sure there are no leaks in the suction piping that might allow air to be drawn into the pump. The pump must never support the piping. Placing that kind of stress on the casing can cause it to crack or become sprung enough to cause damage to the rotating assembly.

Now that the casing is assembled and the piping is in place, we can spin the impeller and begin moving water. Water will enter from the suction side of the volute and will be slung out of the impeller into the discharge side of the volute. Unfortunately, the water will try to pass from the high-pressure side back to the suction side and recirculate through the impeller again.

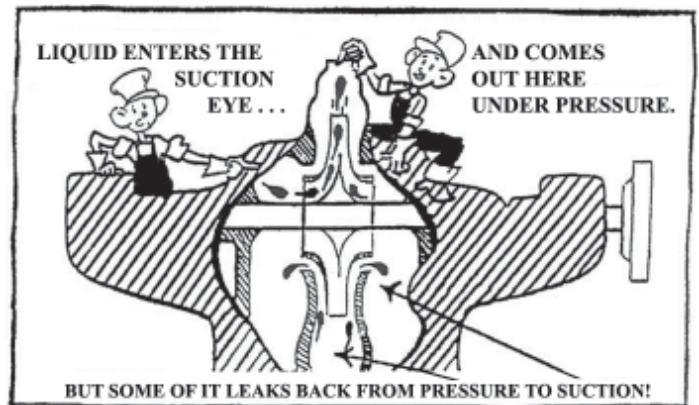
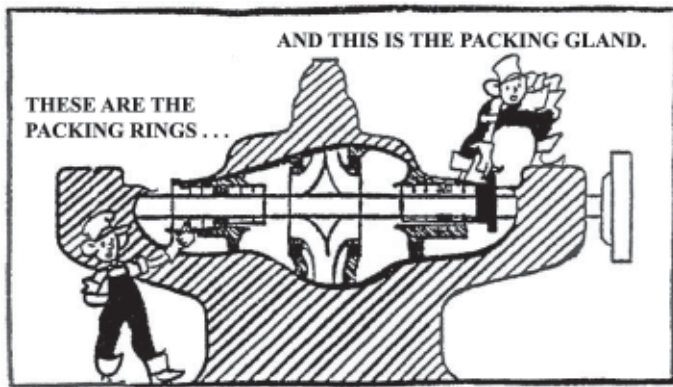

Figure 9.9 - Leak Back

The pump casing could have been machined to close this gap, but the fit would become worn and widened over time. To prevent this internal recirculation, rings are installed between the pump and the impeller that reduce the clearance between them to as little as 0.010". Unlike the casing, these rings are removable and can be replaced when they become worn. Because they wear out and get replaced, they are called wear rings.

There is another area of the pump that will require some attention. Something must be done to plug the hole where the shaft enters the pump casing. This is a place where water can leak out and air can leak into the pump. Neither of these situations is acceptable. The part of the pump casing that the shaft passes through is called the stuffing box. It's called the stuffing box because we are going to stuff something in the box to keep the water in and the air out.



**Figure 9.10 - Stuffing Material**

This “stuffing” will usually be rings of pump packing. Several rings of packing are placed in the stuffing box. A metal insert ring fits on top of the stuffing box and is used adjust or tighten the packing down to minimize water leakage. It is called a packing gland.

Since the packing rings touch the shaft sleeve as it rotates, friction and heat are generated in the stuffing box when the pump is running. Water is generally used to cool the packing rings during operation. This means that some water must leak out of the stuffing box when the pump is running. Water may simply be allowed to leak through the packing rings from inside the pump to cool them.

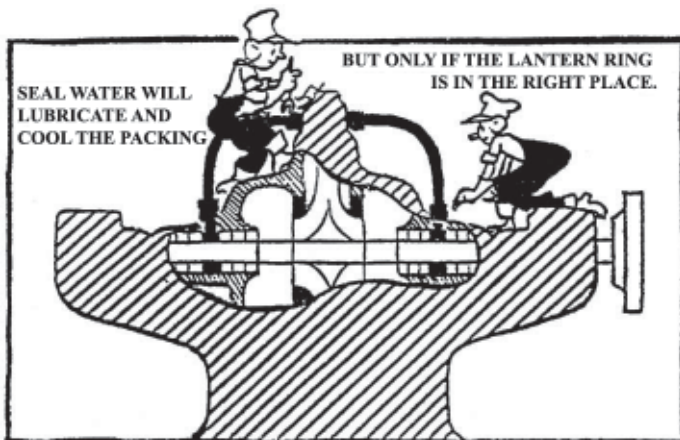

**Figure 9.11 - Seal Water**

This water may be come from the low-pressure side of the pump and may not be under enough pressure to leak past the packing rings when the packing gland it properly adjusted. If this is the case, high-pressure water from the discharge side of the pump may have to be piped into the stuffing box. Seal water piping is used to supply this water to the packing. The seal water enters the stuffing box from the outside, but it’s needed on the inside.

A lantern ring is used to get the water to the inside of the packing rings where the heat is being generated. The lantern ring is a metal ring that has holes in it. Water circulates around the outside of the lantern ring and passes through the holes to get to the inside of the packing rings. The lantern ring must be aligned with the seal water port on the stuffing

box to make sure that water will get to the center of the stuffing box. Whenever a potable supply is used for a pump that is pumping non-potable water, an air gap or reduced pressure backflow preventer must be used to prevent a possible cross-connection.

If there isn’t enough seal water moving past the packing and rotating pump shaft to cool them properly, the packing will overheat. If the packing is allowed to overheat, the lubricant in the packing will be driven away from the shaft and the packing will become glazed, much like nylon cord that has been burned at the end. The glazed packing will then start cutting into the shaft sleeve, creating more friction

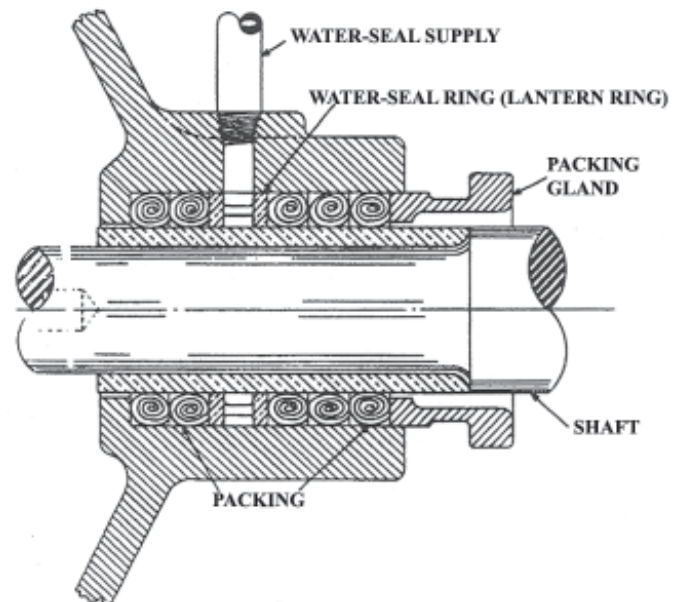

**Figure 9.12 - Stuffing Box Cross-Section**

and heat. The result will be packing failure and a severely damage shaft sleeve.

Pumps that do not have packing in the stuffing box will be equipped with a mechanical seal. [See Figure 9.13.] Mechanical seals are comprised of two highly polished seal faces. One seal face is inserted in a gland ring that replaces the packing gland on the stuffing box. The other seal face is attached to the rotating shaft. It is held in place with a locking collar and is spring loaded so that there is constant pressure pushing the two seal faces together.

When the pump runs, seal water is piped into the stuffing box under enough pressure to force the seal faces apart. The seal faces don’t touch when the pump is running, but the friction loss created as the water pushes them apart prevents any leakage from the gland plate. Failure of the seal water system will result in the seal faces rubbing against each other. The friction that is generated when this happens can destroy a mechanical seal in a matter of seconds.

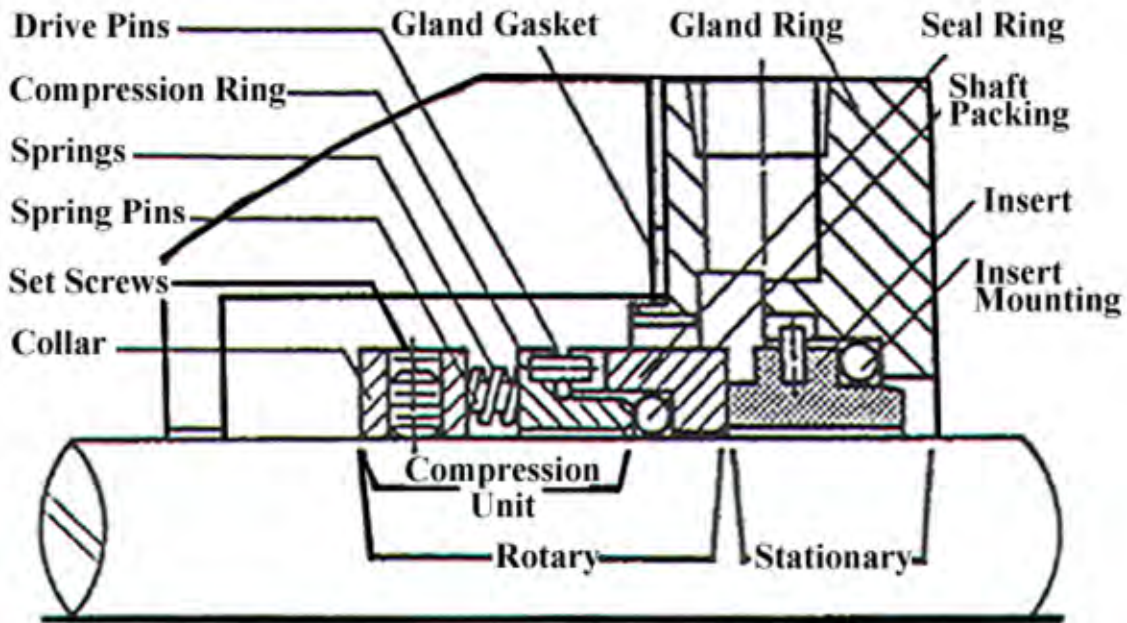

Figure 9.13 - Mechanical Seal Components

## PUMP HYDRAULICS

When a pump is installed, it is important to make sure that it is designed to pump the proper amount of water against the correct head pressure. Pumps that are not properly sized for a specific application will fail to give satisfactory performance. The majority of complaints regarding pump performance usually result from placing a pump in an application that requires it to operate outside its designed flow or pressure ratings.

In order to get the right pump for the job, you must know not only how much water must be moved, but also how much pressure it is going to have to pump against. Determining how much water needs to be pumped is the easy part. A pump dealer may have fifteen different pumps that are rated for 500 gpm. Some of them will pump 500 gpm against 500 feet of head and some will only pump 500 gpm against 50 feet of head pressure. The trick is figuring out how much pressure the pump will have to work against.

The following steps should be taken when sizing a pump:

1. **Determine the gpm:**

The pump should be able to meet the peak daily demand that will be encountered.

2. **Determine the suction head:**

The suction head is the vertical distance from the surface of the water supply to the centerline of the pump. If the water supply is below the centerline of the pump, the distance is negative suction head, or suction lift. If the water supply is above the centerline of the pump, it is known as positive suction head. The illustration shows both positive and negative suction heads of 20 feet. Atmospheric pressure and the ability of the pump to pull a vacuum limit negative suction head. At sea level the absolute maximum negative suction head is 33.8 feet. For most pumping applications negative suction heads should never exceed 20 feet.

3. **Determine the discharge head:**

The discharge head is the vertical distance from the centerline of the pump to the overflow of the storage tank. The illustration shows a discharge head of 60 feet.

4. **Determine the total head:**

The total head can be determined by **adding** a **negative suction head** to the discharge head:

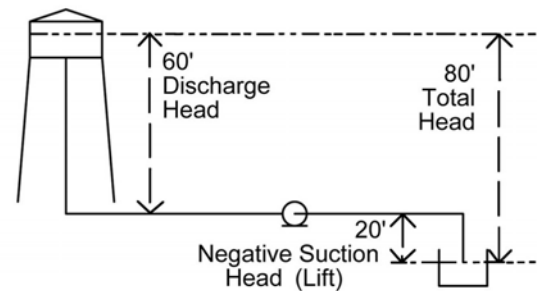

$$\text{Total Head} = \text{Discharge Head} + \text{Negative Suction Head}$$

or

by **subtracting a positive suction head** from the discharge head:

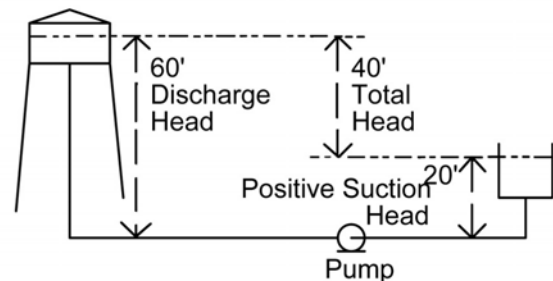

$$\text{Total Head} = \text{Discharge Head} - \text{Positive Suction Head}$$

Figure 9.14 - How to Determine Total Head

### 5. Determine the friction loss:

The total head represents the vertical distance that the pump must lift the water. The horizontal distance the water must move will also impact the pressure against the pump. As water moves through a pipe, it rubs against the inside of the pipe. This creates friction that will reduce the available pressure at the end of the pipe. A pump must produce a pressure higher than total head to overcome this friction loss and still move the required amount of water. There are four factors to consider when determining friction loss. They are the size of the pipe, the flow through the pipe, the length of the pipe, and the "C factor". The "C factor" is also known as the coefficient of friction. It represents the roughness of the inside of the pipe wall.

### 6. Determine the Total Dynamic Head

Once the friction loss has been determined, it is **added** to the total head to calculate the total dynamic head. The total dynamic head (TDH) is the head at which the pump should be rated. The pump can now be sized according to the gpm demand and the total dynamic head that it must work against.

$$\text{T.D.H.} = \text{Discharge Head} \pm \text{Suction Head} + \text{Friction Loss}$$

### PUMP CHARACTERISTICS CURVES

Every pump has certain characteristics under which it will operate efficiently. These conditions can be illustrated with pump characteristic curves. The graph of the pump curve should show:

- 1) The head capacity curve (A)
- 2) The brake horsepower curve (B)
- 3) The efficiency curve (C)

The graph may contain a curve labeled "NPSH" (Net Positive Suction Head) instead of a BHP (Brake Horsepower) curve. NPSH represents the minimum dynamic suction head that is required to keep the pump from cavitating.

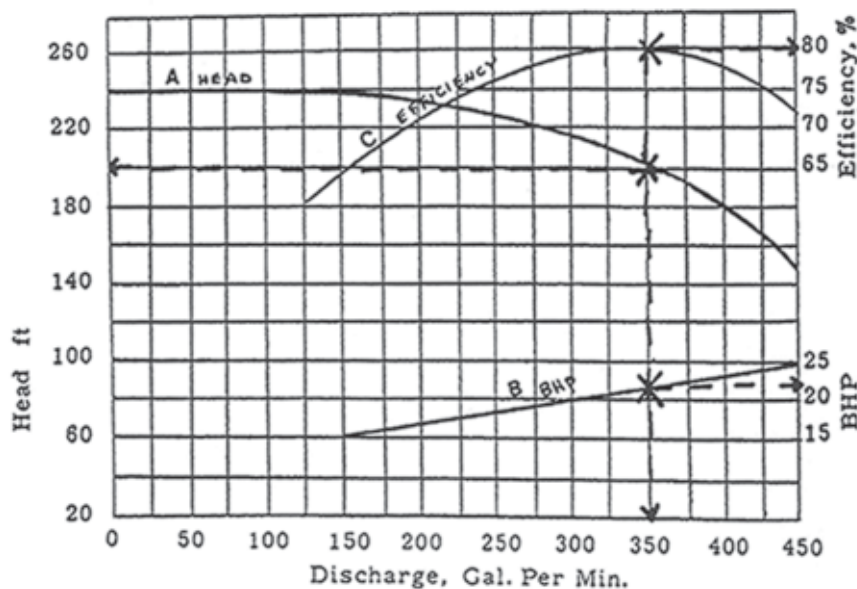

Figure 9.15 - Pump Curve

To use the pump curve:

1. Start at the particular head pressure that is desired and then travel across the chart to the point where it crosses the head capacity curve (A).
2. Drop a straight line from this point down to the bottom of the chart to determine the gpm output at that particular head pressure.
3. The brake horsepower can be determined by starting at the point where the vertical line crosses the horsepower curve (B) and going across to the right side of the chart. Use the same procedure for NSPH if it is used instead of BHP.
4. The efficiency of the pump at this flow and pressure is determined by starting at the point where the vertical line crosses the efficiency curve (C) and going over to the right side of the chart.

When the head pressure of the pump represented by this curve is 200 feet, the output is 350 gpm. The brake horse-power under these conditions is about 22 BHP and the efficiency is 80%. If the impeller or the speed of the pump changes, all of the pump's characteristics will also change.

### SHUT OFF HEAD

The highest head pressure that the pump will develop is called the "shut off head" of the pump. The shut off head for the pump in this curve is 240 feet of head. When a pump reaches shut off head, the flow from the pump also drops to 0 gpm. This is a valuable piece of information for conducting a quick check of the pump's performance. If the pump cannot generate its rated shut off head, the pump curve is no longer of any real value to the operator. A loss of shut off head is probably caused by an increase in recirculation inside the pump due to worn wear rings or worn impellers.

There is another factor that might affect the shut off head of the pump. The pump curve assumes that the pump is running at design speed. If a pump that is supposed to spin at 1750 rpm and it is only turning at 1700 rpm, the shut off head will be lower than the pump curve too. However, if the pump speed is checked with a tachometer and found to be correct, the wear rings or impellers are probably in need of repair.

### Checking Shutoff Head

It is fairly easy to check the shut off head on a pump if it has suction and discharge pressure gauges:

1. Start the pump and close the discharge isolation valve. This will create a shut off head condition since the flow has been reduced to 0 gpm. The pump should not operate at shut off head for more than a minute or it will begin to overheat.

**NOTE:** NEVER attempt to create shut off head conditions on a multi-staged turbine well. The shut off head may be several hundred feet higher than normal operating pressure, which can cause damage to piping.

2. With the pump running at shut off head, read the suction and discharge pressure gauges. Subtract the suction pressure from the discharge pressure to get the shut off head. Compare the field readings to the pump curve to see if the wear rings are in need of replacement.

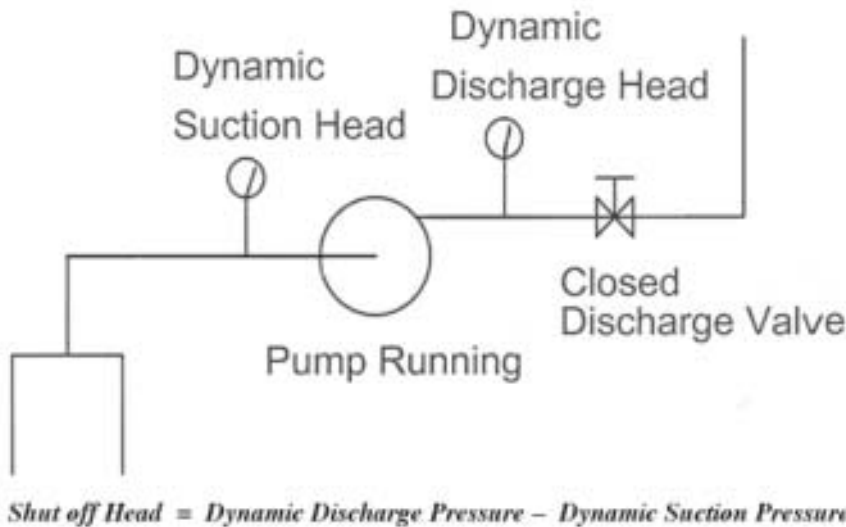

**Figure 9.16 - How to Determine Shut-Off Head**

If the shut off head matches the curve, the same calculation can be used, when the pump is running normally, to estimate the Total Dynamic Head (TDH) and determine the flow when a meter is not available.

## COMMON OPERATIONAL PROBLEMS

The operator should check all pumps and motors every day to insure proper operation. After spending a certain amount of time with these pumps and motors an operator should be able to tell just by listening to them whether they are work-ing properly. The vast majority of pumping problems are either a result of improperly sizing a pump for the job or one of the three following operational problems.

### CAVITATION

One of the most serious problems an operator will en-counter is cavitation. It can be identified by a noise that sounds like marbles or rocks are being pumped. The pump may also vibrate and shake. In severe cases, piping can be damaged. Cavitation occurs when the pump starts discharging water at a rate faster than it can be drawn into the pump. This situation is normally caused by the loss of discharge head pressure or an obstruction in the suction line. When this happens, a partial vacuum is created in the impeller causing the flow to become very erratic. These vacuum-created cavities are formed on the backside of the impeller vanes.

As the water surges into the impeller, the partial vacuum is destroyed and the cavities collapse, allowing the water to slam into the impeller vanes. These cavities form and collapse several hundred times a second. As they collapse, they draw the water behind them into the impeller at about 760 mph! The impact created by the water slamming into the impeller is so great that pieces of the impeller may be chipped away.

When cavitation occurs, immediate action must be taken to prevent the impeller, pump and motor bearings, and piping from being damaged. Cavitation can be temporarily corrected by throttling the discharge valve. This action prevents damage to the pump until the cause can be found and corrected. Remember that the discharge valve is there to isolate the pump, not control its flow. If it is left in a throttled position the valve face may become worn to the point that it won't seal when the pump must be isolated for maintenance.

If you suspect that low suction pressure is the problem, check the pump curve to see what the Net Positive Suction Head (NPSH) is for the pump. If there is no NPSH curve, check with the pump supplier.

### AIR LOCKING

**Table 9.2 - Causes of Cavitation**

- |   |  |
|---|--|
| ■ | Loss of discharge pressure due to open hydrants or line breaks |
| ■ | Closed suction valve   |
| ■ | Obstruction in the suction line                                |
| ■ | Low suction head due to drop in water level                    |

Air locking is another common problem with pumps. It is caused by air or dissolved gases that become trapped in the volute of the pump. As the gas collects, it becomes compressed and creates an artificial head pressure in the pump volute. As more air collects in the pump, the pressure will continue to build until shut off head is reached. Air locking is most often caused by leaks in the suction line. The failure of low level cut off switches, allowing air in from the wet well, may also cause air locking.

An air locked pump will overheat in a matter of minutes. The shut off head conditions mean that no water is moving through the pump. Vertical pumps that use internal leakage to cool packing may also experience packing ring failure, since the trapped air can prevent water from reaching the packing.

Air relief valves are used to prevent air locking. They are located on the highest point on the pump volute and automatically vent air as it accumulates in the pump. It is also a good idea to repair leaking gaskets and joints on the suction piping. If the pressure in the line drops below atmospheric pressure when the pump is running, air will leak in instead of water leaking out.

### **LOSS OF PRIME**

Loss of prime happens when water drains out of the volute and impeller. The impeller can't create any suction at the impeller eye unless it is filled with fluid. This occurs only when negative suction head conditions exist. Pumps that operate with negative suction lift are usually installed with a foot valve or check valve at the bottom of the suction pipe. This valve holds the water in the suction pipe and pump when the pump is off.

When a pump loses its prime it must be shut down, reprimed, and all the air bled out of the suction line before starting the pump again. Worn packing and a defective foot valve normally cause loss of prime. The best way to prevent loss of prime is to design a pump installation so that there is positive suction head on the pump.

## **ELECTRIC MOTORS**

Very few operators do electrical repairs or trouble shooting because this is a highly specialized field and unqualified operators can seriously injure themselves or damage costly equipment. For these reasons the operator must be familiar with electricity, know the hazards, and recognize his own limitations when working with electrical equipment. Most water systems use a commercial electrician for major problems. However, the operator should be able to explain how the equipment is supposed to work and what it is doing or not doing when it fails. Electric motors are commonly used to convert electrical energy into mechanical energy. A motor generally consists of a stator, rotor, end bells, and windings. The rotor has an extending shaft, which allows a machine to be coupled to it. Most large motors will be three phase motors rated from 220 or 4160 volts.

Vertical turbine line shaft pumps will often have a hollow core or hollow shaft motor. The rotor is hollow and the motor shaft can slide up and down to allow adjustment of impeller clearance. This lateral adjustment is accomplished by raising and lowering the shaft with the adjusting nut on top of the upper bearing.

### **PHASES**

The term "phase" applies to alternating current (AC) systems and describes how many external winding connections are available from a generator, transformer, or motor for actual load connections. Motors are either single-phase or three-phase.

### **SINGLE PHASE MOTORS**

Single-phase motors are normally operated on 110 220 volt A.C. single-phase systems. A straight single-phase winding has no starting torque so it must incorporate some other means of spinning the shaft. A single-phase motor requires a special start circuit within the motor to make sure it runs in the right direction. Several different types of starter windings are available in these motors. Single-phase power leads will have three wires, like a three-prong extension cord. The third

### **THREE PHASE MOTORS**

Three-phase systems refer to the fact that there are three sets of windings in the motor and three legs of power coming in from the distribution system. This type of motor is used where loads become larger than single-phase circuits can handle. With three legs to carry power, more amps can be delivered to the motor. Three phase motors are the most common types used in water and wastewater systems. Three major types of three phase motors are the squirrel cage induction motor, synchronous motors, and wound rotor induction motors.

Squirrel cage induction motors are widely used because of its simple construction and relative low maintenance requirements. The windings are stationary and are built into the frame of the motor. The power supply is connected to the windings in the stator, which creates a rotating magnetic field. The rotor is made up of bars arranged in the shape of a cylinder and joined to form a "squirrel cage." Squirrel cage induction motors make up approximately 90% of all motors used in industry today.

Three-phase motors do not use a start circuit. The direction of rotation is determined by how the three leads are wired to the motor. If any two of the leads are switched, the motor rotation will be reversed.

### **SINGLE PHASING**

Anytime a lead becomes grounded, a dead short develops, or one of the contacts opens in a three-phase motor, single phasing will result. When this occurs, the speed of the motor will drop and it will begin to overheat. The single phase will draw too many amps and it will quickly burn up. When single phasing occurs while the motor is not running, it simply will not start up again. Special circuit protection is available that will shut the motor off if single phasing occurs.

### **CIRCUIT PROTECTION**

Motors need to be protected from power surges and overloads. Fuses and circuit breakers are designed to open the circuit when the current load threatens to damage the motor. Fuses are generally sized at 120-150% of motor capacity. Circuit breakers can be reset when they trip, instead of being replaced like a fuse. Circuit breakers can react faster than fuses and are usually sized closer to the current rating of the motor.

---

## References

Office of Water Programs, California State University, Sacramento,  
*Water Treatment Plant Operation*, Volume 2, 3<sup>rd</sup> ed., 2000,  
Chapter 18

Office of Water Programs, California State University, Sacramento,  
*Water Distribution System O&M*, 3<sup>rd</sup> ed., 1996, Chapters 5 & 7

Office of Water Programs, California State University, Sacramento,  
*Small Water System O&M*, 4<sup>th</sup> ed., Chapter 3  
*Groundwater and Wells*, 2<sup>nd</sup> ed., Chapter 17

---

## BASIC STUDY QUESTIONS

1. What are wear rings?
2. What three factors determine total dynamic head?
3. What happens when you increase the pressure on a centrifugal pump?
4. What are some of the possible causes of cavitation?
5. What does single phasing in a three-phase motor mean?

## BASIC SAMPLE TEST QUESTIONS

1. A lantern ring:
  - A. Must be located in line with the seal water port
  - B. Is used to cooling water to the center of the stuffing box
  - C. Will be found in the stuffing box
  - D. All of the above
2. The discharge piping of a centrifugal pump will be larger than the suction piping.
  - A. True
  - B. False
3. Air trapped in the volute of the pump will cause:
  - A. Cavitation
  - B. Air locking
  - C. Loss of prime
  - D. All of the above
4. Which type of pump would be used in a well?
  - A. Vertical turbine centrifugal
  - B. Split case horizontal centrifugal
  - C. End suction centrifugal
  - D. Positive displacement

## ADVANCED STUDY QUESTIONS

1. What does the term “C” factor refer to?
2. What is the best way to prevent loss of prime?
3. What are four conditions that could cause cavitation in a centrifugal pump?
4. How do you reverse the rotation of a three-phase motor?
5. What kind of information is found on a pump curve?

## ADVANCED SAMPLE TEST QUESTIONS

1. The maximum pressure a centrifugal pump can generate is called:
  - A. Shutoff head
  - B. Total dynamic head
  - C. Total head
2. Negative suction head should never exceed:
  - A. 10 feet
  - B. 20 feet
  - C. 30 feet
  - D. 40 feet
3. Which of the following would make a centrifugal pump stop cavitating?
  - A. Throttle the suction valve
  - B. Throttle the discharge valve
  - C. Decrease the TDH
  - D. Decrease the NPSH

BLANK PAGE



# CHAPTER 10: MECHANICAL SYSTEMS

---

Like any other business, a water system spends a great deal of money on infrastructure and capital improvements. These expenses include piping, storage and all of the mechanical equipment required to produce, treat, and deliver water. A maintenance program is essential to insuring that the mechanical components of the system stay in good working order and provide the longest possible service life. A preventive maintenance schedule should be utilized to make sure that each piece of equipment gets the proper attention. Most preventive maintenance consists of inspecting, cleaning, and lubricating the equipment. The equipment operators can usually complete these tasks. Specially trained personnel that possess the necessary mechanical skills should handle major maintenance, including component replacement and overhaul.

## PUMP MAINTENANCE

The most common piece of equipment in a water system is the centrifugal pump. There are several maintenance procedures that must be performed periodically for any centrifugal pump. Pump packing wears out, bearings must be lubricated or replaced, mechanical seals need replacing, couplings must be maintained, and motor and pump shafts must be aligned. These procedures are not difficult to learn. Some of the procedures may require the use of a few special tools. Once an operator understands the basic procedures and has a chance to put the theories into practice, it doesn't take long to become proficient at each task.

## PUMP PACKING

Pump packing is one of the biggest problem areas for operators in charge of pump maintenance. Poor maintenance of pump packing is responsible for more pump damage than any other maintenance item. Improperly maintained packing can cause several problems including:

**Table 10.1 - Damage Caused by Packing Failure**

---

- **Loss of prime or suction due to an air leak**
  - **Shaft and sleeve damage**
  - **Water contamination of bearings**
  - **Flooding of pump stations**
- 

There are many different types of pump packing available for use in today's pumps. The most common type of packing comes in a square braided stock. There are a number of different kinds of braided packing. It can be manufactured from jute, asbestos, nylon, Teflon or other synthetics. It can be lubricated with graphite, grease, or other synthetic

lubricants such as Teflon. Prices for packing range from several dollars a pound for graphite-impregnated jute to hundreds of dollars a pound for pure Teflon and other synthetics.

A rule of thumb is to buy the most expensive packing that you can afford, provided that you are taking care of the rest of the pump properly. If scored or damaged shaft sleeves and out of round or bent shafts are not going to be repaired, use the cheapest packing you can get. Expensive packing will not last any longer than the cheap stuff if the sleeve is scored or the shaft is bent. If the rest of the pump is properly cared for, the more expensive types of packing will last several times longer than the cheap packing and will usually pay for itself with a longer life.

## REMOVING OLD PACKING

It's time to replace the packing when there is no more adjustment left in the packing gland and there is too much leakage from the stuffing box. When this occurs, all of the packing rings must be replaced. Adding an additional ring or just replacing one or two rings will only lead to premature packing failure and damage to the shaft and sleeve. Use the following procedure to remove the old packing:

1. Tag the pump in the "OFF" position and lock it out so that it can't be accidentally restarted.
2. Isolate the pump by closing the suction and discharge valves.
3. Drain the pump by opening the drain cock or removing the drain plug in the bottom of the volute.
4. Remove the packing gland. If it is not split for removal from the shaft, it should be tied off so that it is out of the way.
5. Remove the packing rings with a packing puller (corkscrew on the end of flexible T-handle) taking care not to score the shaft sleeve.
  - Measure the distance to the lantern ring and then remove it with the packing puller. It may take a puller on each side of the lantern ring to pull it out without getting it cocked sideways. If the lantern ring is split, it can be removed from the shaft. If you're not sure that the lantern ring was in the right placed to begin with, measure the distance from the face of the stuffing box to the seal water port or refer to the vendor's engineering drawing of the stuffing box for the correct position.
7. Remove the remaining packing rings and clean the stuffing box and shaft.
8. Disconnect, inspect, and clean the seal water line and seal water port.
9. Inspect the shaft or shaft sleeve. If it is scored or grooved, the pump should be dismantled and the shaft dressed or repaired by a machine shop.

## REPACKING THE PUMP

Before new rings are cut, it is important to determine the size and number of packing rings that are needed for the stuffing box. This information should be available in the vendor's engineering drawings. If these drawings are not available, measurements of the stuffing box and shaft can be used to make the determination. The correct packing size is determined using the following procedure:

1. Measure the inside diameter of the stuffing box and the outside diameter of the shaft.
2. Subtract the shaft diameter from the stuffing box diameter.
3. Divide the difference by two. (See Figure 10.1)

The correct number of rings can be determined using the following procedure:

1. Measure the depth of the stuffing box.
2. Divide the depth of the stuffing box by the size of the packing to get the total number of rings.
3. Subtract one from this total if a lantern ring is used in the stuffing box.

Once the size and number of rings has been determined, the new packing can be cut and installed. Great care should be taken to keep the packing material clean and free from dirt. Packing spools should be stored in plastic bags to prevent contamination. Dirt and grit in the packing rings will lead to serious shaft and sleeve damage. The two most important aspects of cutting packing rings involve cutting them the right length and cutting them so the ends will butt together squarely. Cutting rings the same length with ends that butt together squarely can be accomplished using the following procedure:

1. Cut the packing to the proper length and shape using a very sharp knife or carton cutter. Wrap the packing material around the shaft, an old sleeve, or even a piece of hardwood turned to the proper diameter. Cut all of the rings at once with the packing on the shaft to insure that the ends will butt together squarely.
2. Wrap each ring of packing around the shaft and seat it in the stuffing box completely before adding the next ring. Open the ring by twisting it instead of pulling the ends apart. A light coat of grease on the outside of the ring will make it much easier to push into the stuffing box. Stagger the joints of the rings so that they are 90 degrees apart. Make sure the lantern ring lines up with the seal water port when it is installed.
3. Install the packing gland. Make sure the gland tightened down evenly. It is usually made out of cast material and will break easily if it gets in a bind.

## ADJUSTING THE PACKING GLAND

The final adjustment of the packing gland is made while the pump is running. The pump can be restarted once the

locks and tags have been removed, the dis-charge and suction valves are completely opened, and the pump has been primed. More packing jobs have been ruined by improper gland adjustment than any other single reason. Adjust the packing gland using the following procedure:

1. Tighten the gland one half turn a time on each side until it just begins to put pressure on the packing.
2. Start the pump and tighten the gland until the flow of water is reduced just enough to prevent flooding the drain line. Allow the pump to run for at least five minutes while the packing rings seat. Never allow the packing to get hot during this "breaking in" period. If the packing heats up and lubricant is seen oozing from the gland, the packing is already ruined and should be removed and replaced immediately.
3. After five minutes, adjust the packing slowly until the leakage is reduced to the desired level. The appropriate amount of leakage will vary with the size of the pump and type of packing, but a general rule of thumb is 20-60 drips per minute. Tighten the gland and checking the water temperature periodically. When the water turns lukewarm there is not enough flow to cool the packing properly. Loosen the packing gland just enough to cool the water back down to room temperature. The packing gland will probably need to be checked again, as the packing rings get properly seated. This may have to be done several times over the next 24 hours of run time.

## BEARING MAINTENANCE

Proper bearing lubrication is a critical part of getting the designed life out of pump and motor bearings. As strange as it may sound, more bearings have failed from over-lubrication than from lack of lubrication. In fact, some bearings never require lubrication and may fail if they are greased. Shielded and sealed bearings come factory-lubricated and have sufficient lubricant to last the life of the bearing. Shielded bearings have a metal skirt that is attached to the outer race. It covers the rollers but doesn't touch the inner race. Sealed bearings have a rubber skirt that does touch the inner race. Bearings that do require periodic grease lubrication use a surprisingly small amount of grease when compared to the bearing housing size. A properly greased bearing will have a bearing housing that is never more than 25-30% full. The grease is responsible for lubricating and cooling the bearing.

Grease that is inside the bearing will get hot as the bearing heats up. When the grease gets hot it becomes more fluid and is thrown out of the bearing and onto the wall of the bearing housing, where it cools. Grease that is outside the bearing is drawn into the race, where it again heats up and is thrown out. This process keeps the bearing lubricated

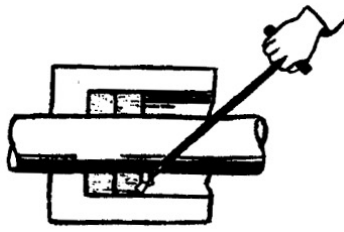

REMOVE OLD PACKING

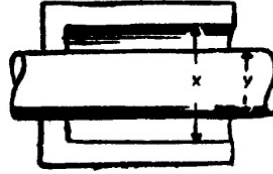

$$\frac{X - Y}{2} = \text{PACKING SIZE}$$

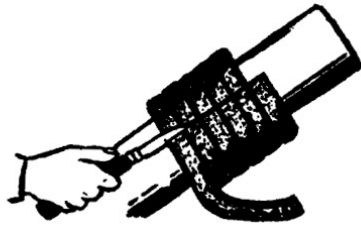

CUT AND FLATTEN PACKING



Right

Wrong



MAKE SURE ENDS ARE SQUARE

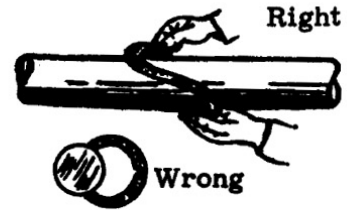

Right

Wrong

INSTALL NEW PACKING

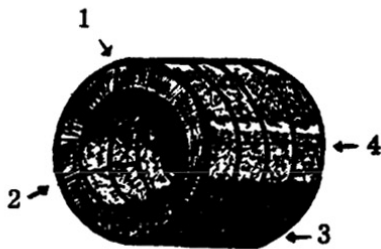

STAGGER PACKING RINGS

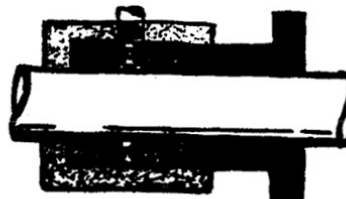

POSITION LANTERN RING PROPERLY

Figure 10.1 - Repacking A Pump

and removes heat from the bearing. If the bearing housing is full of grease there is no way for the hot grease to get out of the bearing. The lubricant inside the bearing overheats and breaks down. Bearings overheat and fail when this happens.

As bearings heat up and cool down, the races and rollers expand and contract. Bearings are temperature stabilized

to about 250°F. This means they will assume their original dimensions as long as the temperature does not rise above 250°F. This is the reason small electric motors should not operate above 105°C. Lubrication schedules for low-speed (under 2500 rpm) anti-friction bearing applications are based on the operating temperature of the bearing. Always refer to the vendor recommendations for the proper lubricant and lubrication frequency.

## COUPLINGS

Couplings connect the motor shaft to the pump shaft. The exception to this would be a close-coupled pump. A close-coupled pump will have the impeller mounted directly to the motor shaft. Couplings can be rubber or steel. Steel couplings are most commonly gear-type or grid couplings.

Couplings are mounted and removed by pressing or heating the coupling. They should never be mounted using a hammer. The halves of the coupling should be separated by a gap large enough to accept the thermal expansion as the shaft and motor heat up. Couplings flex as the two shafts spin. This movement generates friction and heat in the coupling and requires grease lubrication. The main problem with lubrication in a coupling is centrifugation. As the coupling spins, it tries to throw the grease out of the housing.

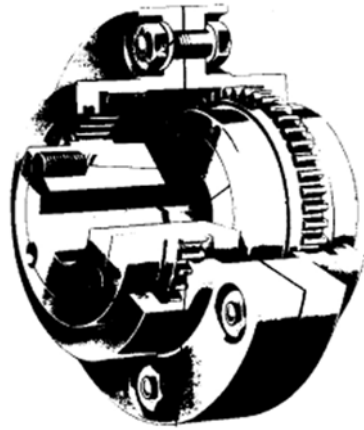

Figure 10.2 - Gear Coupling

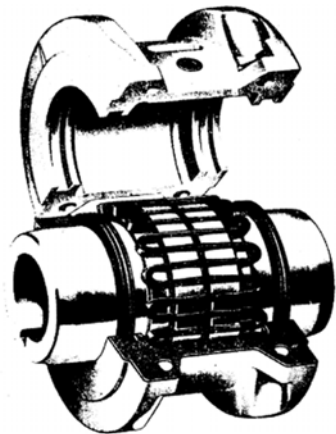

Figure 10.3 - Flexible Grid Coupling

cracking the assembly. Vibration occurs in a coupling when it is misaligned.

## ALIGNMENT

If the pump and motor shafts are not aligned properly, the result will be vibration and subsequent damage to the pump coupling and mechanical seals, and the pump and motor bearings. Misalignment can be angular or offset (parallel.) Angular misalignment means that the motor is crooked when it lines up with the pump shaft. Offset misalignment means that the shafts are in a straight line but one of them

is off center. Misalignment can also be in the horizontal plane, requiring a side-to-side movement of the motor. It can also be in the vertical plane, requiring raising the motor with shims. This means that measurements must be taken at the top, bottom, and both sides of the coupling.

A crude check of the misalignment can be done using a straight edge on the coupling halves. A dial indicator is used to more accurately gauge the amount of offset or angularity. A dial indicator is capable of precise measurements down to 0.001".

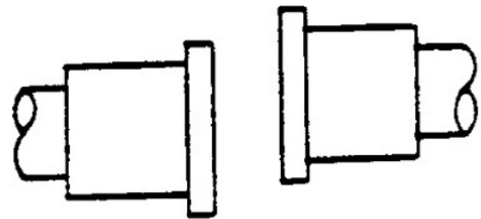

Parallel Misalignment

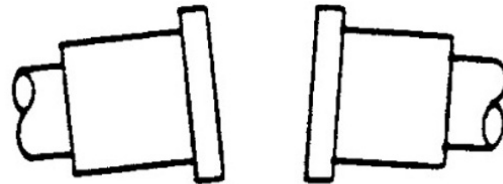

Angular Misalignment

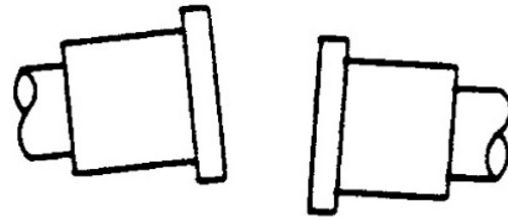

Usually a Combination of Both

Figure 10.4 - Types of Misalignment

## INSTRUMENTATION

Instrumentation in water systems allows the operator to maintain and monitor water levels, flows, pressures, and chemical feed rates at a distance. This use of telemetry gives constant readings of changes in the system and allows operational changes to be made from remote locations. This allows the operator to maintain better control and respond more quickly to changes in the process. The best instruments are those that provide stability, accuracy, and repeatability when monitoring these parameters. Instrumentation equipment can range from simple devices like float switches and pressure gauges to complex systems like on-line chemical analyzers.

Instrumentation is usually set up as either a "feed forward" or a "feedback" loop. An example of a feed forward loop would be a venturi flow meter sending a signal to change a

chlorine dosage based on a change in well field flow. The meter would be located forward of the chlorine feed point and change the stroke when the flow changed. An example of a feedback loop would be a chlorine analyzer changing the chlorine dosage based on a change in residual downstream of the chlorinator. It would be located downstream and feed the information back to the chlorinator.

Three things determine the rate at which an instrument makes a change in the process. One is the amount of change for each reading. This is referred to as the span. Another is how often readings are taken. This is called the rate. The third is the deadband. Deadband means that there is a range around the setpoint where no action is taken. For instance, a chemical feed instrument may be set to maintain a pH of 7.0. But the deadband may be set so that no action is taken until the pH rises to 7.2 or falls below 6.8. If the rate is too fast or the span too large, the control conditions may fluctuate as the instrumentation "hunts" for the setpoint.

## CHEMICAL FEED SYSTEMS

Chemical feeders are necessary to assure that the proper

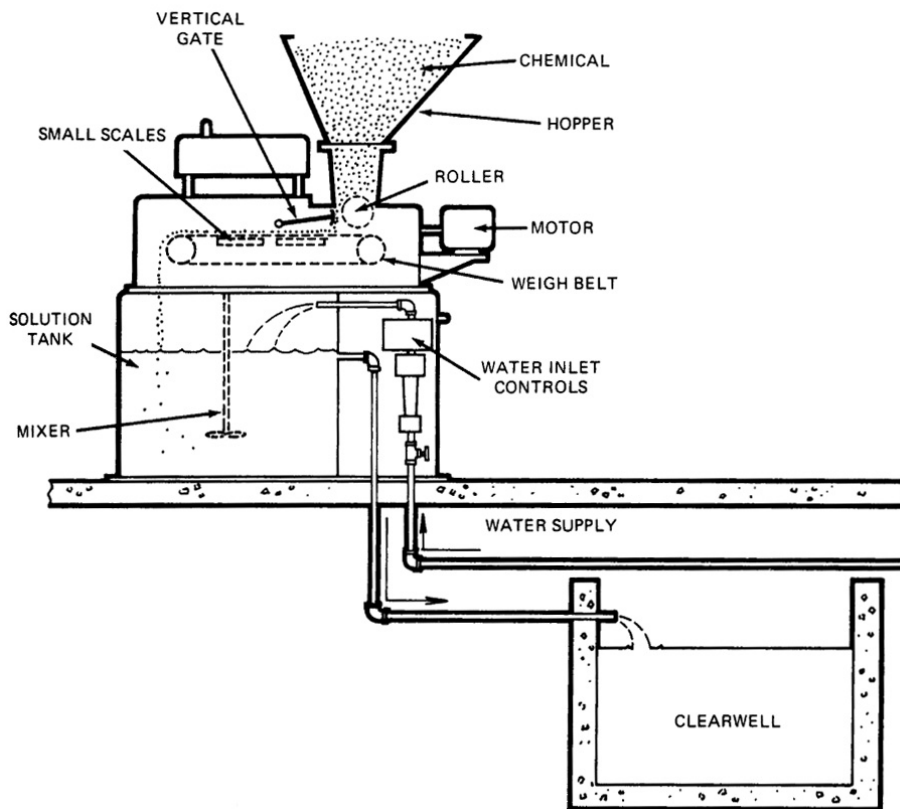

Figure 10.6 - Gravimetric Chemical Feeder

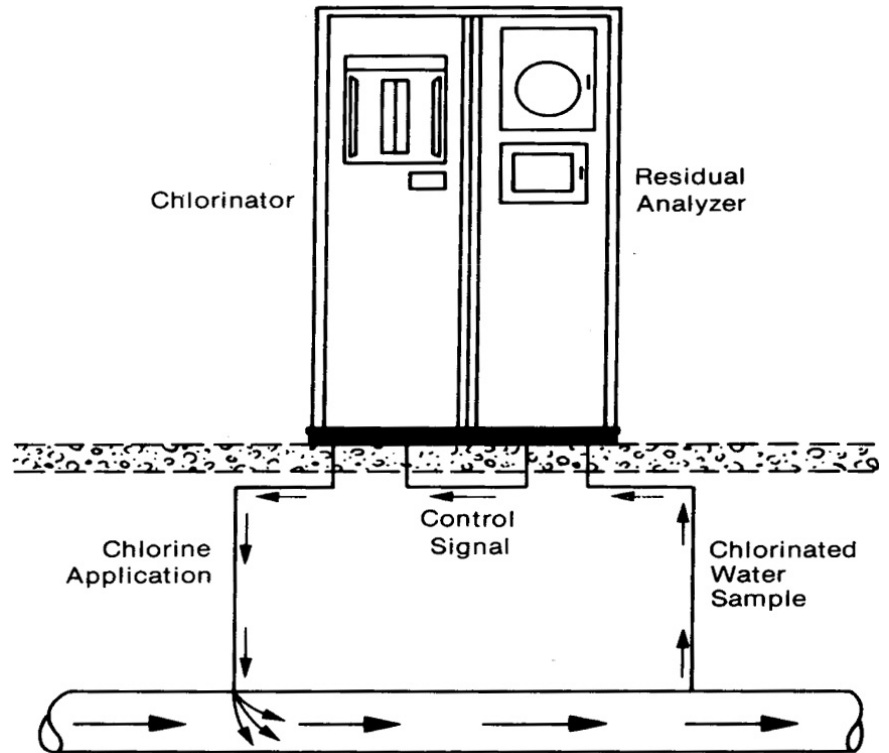

Figure 10.5 - Feedback Control Loop

amount of each chemical is added to the water on a continuous basis. Each feeder must have a storage bin, a device that feeds the chemical into a solution tank where it is dissolved, and a delivery system to add the chemical at

the proper point in the treatment process. Chemical feeders are either gravimetric or volumetric. Gravimetric feeders usually have a conveyor that uses a set of scales to maintain a constant weight of material on the belt. They are not used in water treatment much because most treatment chemicals are corrosive and will damage the scale mechanism. Volumetric feeders are the most common. They include auger feeders and positive displacement metering pumps.

The actual feed device may be a screw auger, a rotating disc, an oscillating shelf, or a variable speed conveyor belt. The feeder control may be calibrated in pounds per day, but usually the scale simply reads from 1 to 10 or 1 to 100. The manufacturer may provide a chart that can be used to determine what the feed rate is a given setting. If not, the operator can calibrate the machine manually. This should be done periodically to determine if the machine

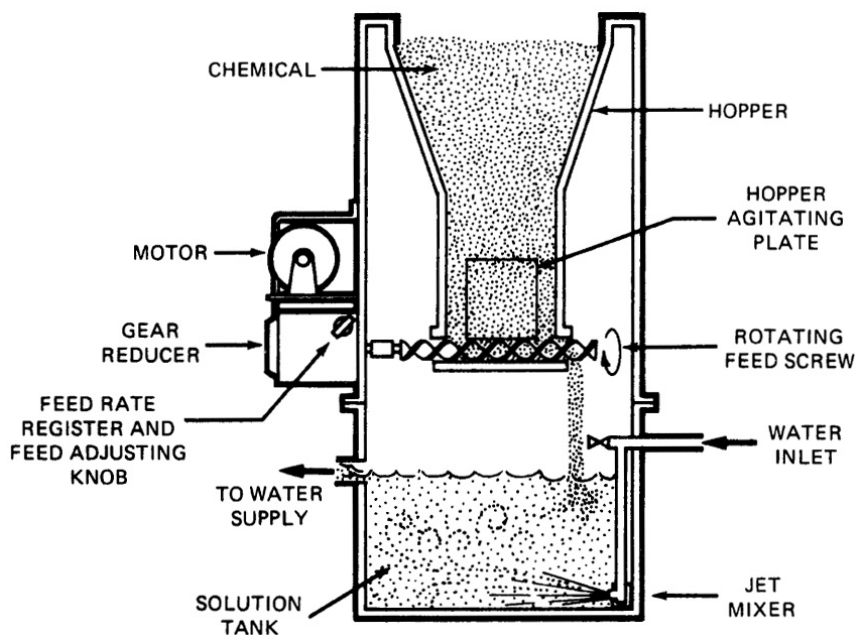

Figure 10.7 - Volumetric Chemical Feeder

is in need of cleaning or maintenance due to clogging or belt slippage. The first step is collecting and weighing the amount of chemical fed in one minute at several different settings. These figures multiplied by 1,440 minutes per day will give pounds per day feed rate. These points can be plotted to create a straight-line graph that can be used to accurately set the feed rate.

Chemical feed pumps are small positive displacement pumps. They are usually diaphragm pumps, but peristaltic pumps are becoming popular for very small systems. Peristaltic pumps consist of a circular pump head that contains a piece of rubber tubing and a roller assembly. As the pump motor turns the roller, fluid is squeezed out of the tube. These pumps can meter flows as low as 3-4 drips per minute (0.1-0.15 ml/min).

The diaphragm feed pump consists of a diaphragm driven pump chamber, and two check valves. The check valves, that provide the one-way flow through the pump, can get clogged with lime deposits. The strainer on the pump suction line should be located several inches above the bottom of the solution tank to prevent lime and grit from being drawn into the pump and fouling the check valves.

If the check valves get fouled, the pump will not pump any solution. Flushing the line with clean water or a weak acid, like vinegar, may also correct the problem. In severe cases the valves may have to be disassembled and cleaned. Always make sure the pump is primed before putting it back into service. It may also be advantageous to locate the pump so that it has a positive suction head.

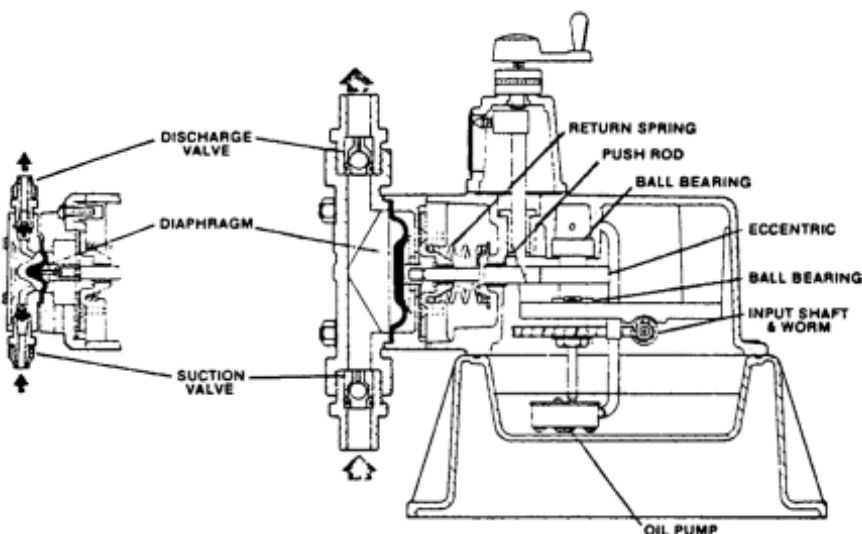

Figure 10.9 - Diaphragm Pump

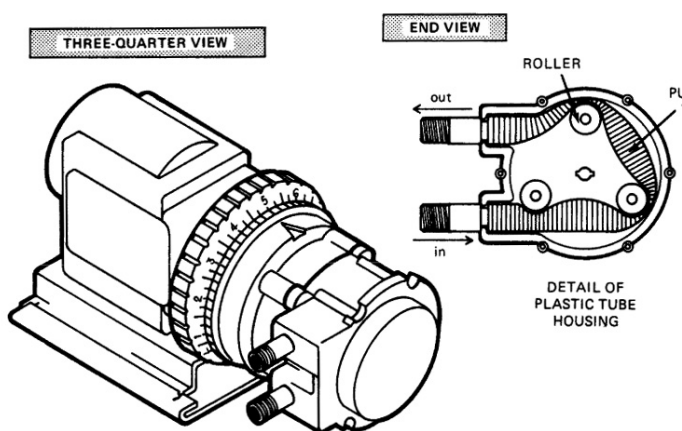

Figure 10.8 - Peristaltic Pump

### References

- Office of Water Programs, California State University, Sacramento, *Water Treatment Plant Operation*, Volume 2, 4<sup>th</sup> ed., 1999, Chapter 13
- Office of Water Programs, California State University, Sacramento, *Small Water System O&M*, 4<sup>th</sup> ed., 2001, Chapter 4

### **BASIC STUDY QUESTIONS**

1. Why is a maintenance program important?
2. What would indicate that it is time to change the pump packing?
3. Why would a bearing that has just been lubricated run too hot?
4. What conditions indicate that a coupling should be replaced?
5. What are the advantages of instrumentation and telemetry?

### **BASIC SAMPLE TEST QUESTIONS**

1. What would a dial indicator be used for?
  - A. Measuring temperature
  - B. Measuring vibration
  - C. Measuring flow
  - D. Measuring shaft misalignment
2. Connect a motor to a pump using:
  - A. A sleeve clamp
  - B. A coupling
  - C. Mechanical seals
  - D. Bailing wire and bubble gum
3. Which of the following would be a good application for a peristaltic pump?
  - A. Booster pump
  - B. Well pump
  - C. Chemical feed pump
  - D. Air compressor
4. Which component in a diaphragm pump causes the most maintenance problems?
  - A. Shaft
  - B. Check valves
  - C. Diaphragm
  - D. Pump head
5. A straight edge can be used as an initial check of coupling alignment
  - A. True
  - B. False

### **ADVANCED STUDY QUESTIONS**

1. What is an instrumentation feedback loop?
2. What causes an instrument to “hunt” for a setpoint?
3. How many places must readings be taken to check motor alignment?

### **ADVANCED SAMPLE TEST QUESTIONS**

1. Misalignment of the pump and motor can cause damage to:
  - A. The coupling
  - B. The bearings
  - C. The mechanical seal
  - D. All of the above
2. An important quality of an instrumentation sensor is:
  - A. Reliability
  - B. Repeatability
  - C. Accuracy
  - D. All of the above
3. Graduated cylinders can be used to:
  - A. Calibrate chemical feed pumps
  - B. Store chemicals
  - C. Adjust mechanical seals
  - D. Prevent surges in the system

BLANK PAGE



# CHAPTER 11: GROUNDWATER & WELLS

## HYDROLOGIC CYCLE

Water is being exchanged between the earth and the atmosphere all the time. This exchange is accomplished with energy supplied by the heat of the sun and the pull of gravity. Water that enters the atmosphere from wet ground, lakes, rivers and the ocean is known as evaporation. Plants also release water to the atmosphere. This process is known as transpiration. It is carried in the air as water vapor. When the water vapor cools and condenses, it changes from a gas to a liquid and falls back to earth as precipitation in the form of rain, sleet, snow, or hail. Evaporation from land and ocean puts water back in the atmosphere, and the exchange goes on continually as water goes from earth to atmosphere to earth. For this reason the exchange of water between earth and atmosphere is called the Hydrologic Cycle.

When precipitation falls, part of the water runs off into natural channels, part of it evaporates, and the remainder seeps or infiltrates into the ground. The amount of water

that percolates farther into the ground water supply depends on the type of soil it must pass through and how much water is retained in the root zone. Plants retain the water in the root zone and release it back to the atmosphere as transpiration. Percolation is the most common means of recharging ground water supplies.

## GROUND WATER SUPPLIES

Water will continue to percolate down through the earth until an impervious stratum is reached. An impervious stratum is a layer of material in the earth that will not allow water to pass through it. This material is usually made of rock formation or clay. As the water reaches the impervious stratum it will begin to collect and saturate the surrounding soil, forming an aquifer. It is a common belief that the water quality of an aquifer is constant throughout the aquifer. In fact, the water quality can change dramatically within the confines of a given aquifer. This can be attributed to changes in the medium or mineral deposits in the zone of saturation. Aquifers are generally classified as Water Table (unconfined) and Artesian (confined).

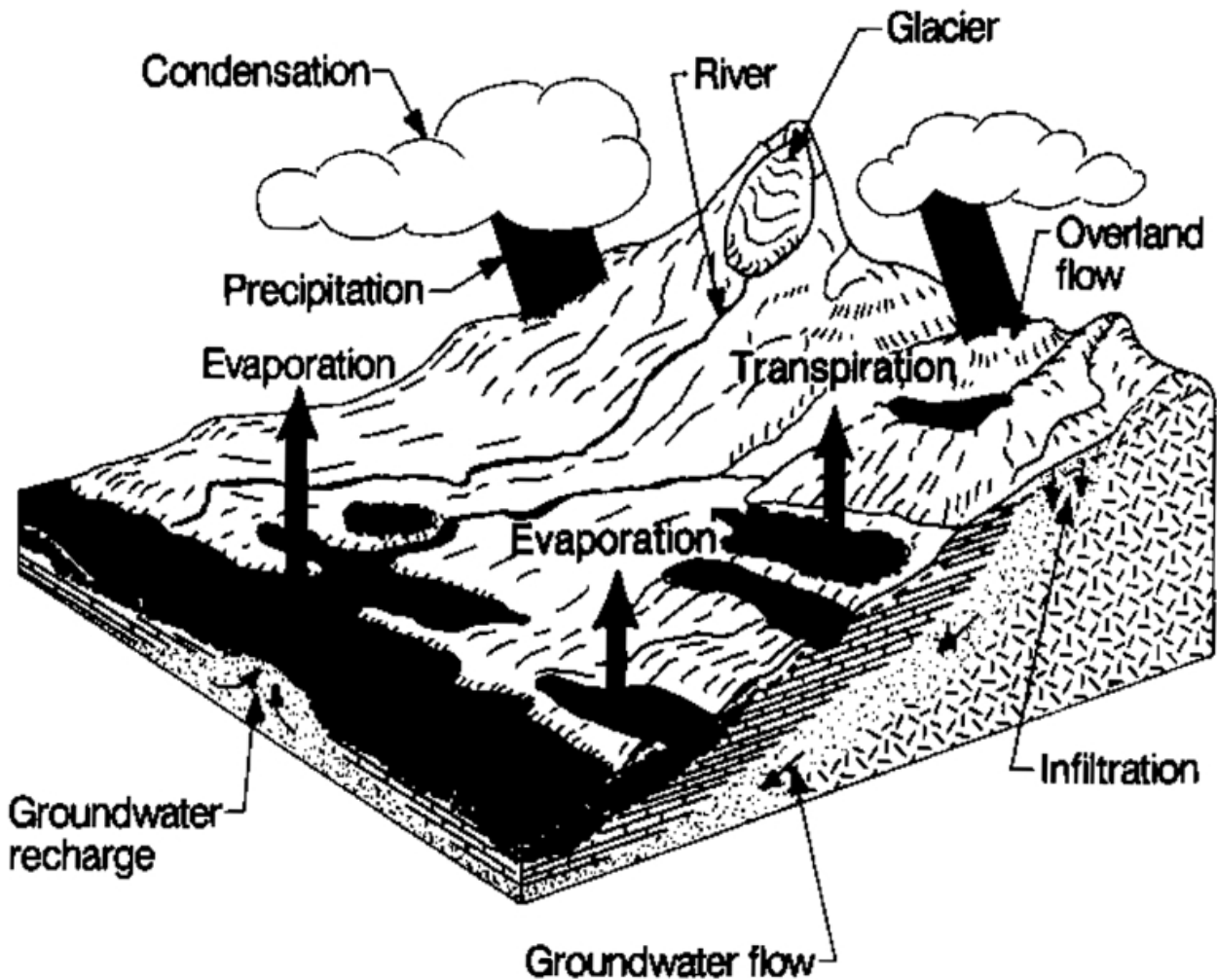

Figure 11.1 - Groundwater & The Hydrologic Cycle

## **WATER TABLE AQUIFER**

An aquifer that is formed from a single impervious stratum and has an upper surface that is free to rise and fall with seasonal changes of recharge rate is known as a water table or unconfined aquifer. This condition allows the free flow of water in the aquifer generally in the same direction as surface water. The water level in a well located in a water table aquifer will not rise above the initial point of encounter.

A perched aquifer is a very small, unconfined aquifer that doesn't contain much water and is only recharged by local precipitation.

## **ARTESIAN WELLS**

Artesian wells originate from groundwater that is trapped between two impervious strata (See Figure 11.2). As the water flows between these strata it becomes confined and, as recharge continues, the water backs up creating pressurized conditions in the aquifer. Water in a well located in an artesian aquifer will rise above the point at which it is first located. If the water rises to the surface it is a free-flowing artesian well. If not, it is called a non-flowing artesian well.

## **TYPES OF GROUND WATER FORMATIONS**

The saturation zone of an aquifer may be any one of several different materials. Most aquifers occur in formations of sand or gravel. Others may be found in limestone, sandstone, shale, clay, or even silt. The type of formation will influence the water quality and yield of a well.

## **WATER WELL LOCATION**

Several factors are involved in selecting a site for a new well. The most important of these is finding adequate quantities of water that will meet SDWA drinking standards with the minimum amount of treatment. Potential pollution of the water supply is another a major concern. Economics related to purchasing easement and connecting to the system, and population or demand within the system will also be factored into the decision. Finally, politics can become an issue in some cases.

Consulting engineers will rely on well logs from other wells in the area, geological data, and test holes to determine where the best chance of finding the appropriate quantity and quality of water exists. But even then, drilling a water well is still a hit or miss proposition.

## **SANITARY CONSIDERATIONS**

Sanitary hazards must be considered when locating a well. NMED should be consulted regarding requirements concerning well location, especially with regards to potential sources of pollution. The minimum distance from a well to a potential pollution source should be at least 200 feet. Potentially hazardous conditions such as petroleum storage

areas, chemical or radioactive disposal sites, and industrial waste treatment facilities may require special consideration as far as well location is concerned. Wells should never be located in a 100-year flood plain.

## **WATER WELL CONSTRUCTION**

Water wells may be classified according to the method of construction. The type of construction will depend on the depth of the well, the geological formations to be encountered, and the amount of water needed for the system.

Small wells, particularly private wells, may be dug or driven. Public water systems usually require more water than either dug or driven wells can produce. The most common method of construction used by public water systems is the drilled well. These wells are ideally suited to deep water bearing formations where larger yields are available. This type of well, when properly constructed offers good protection against contamination from the surface. Two different methods of constructing drilled wells are the cable tool or percussion method and the rotary drilling method.

### **CABLE TOOL METHOD**

The impacts created by raising and dropping a heavy drill bit and stem crushes and dislodges pieces of the formation as the well is drilled. The up and down motion of the drill bit mixes the cuttings with water to form slurry and a bailer is used periodically to remove the slurry. A bailer is made of a 10 to 20 foot section of pipe with a foot or check valve at the bottom. The casing is usually put in place as the well is drilled, especially in loose formations such as sand and sandy loam. Wells drilled by the cable tool method are more likely to have problems with vertical alignment than those drilled by the rotary method.

### **ROTARY DRILLED WELLS**

These types of wells use power driven drill stems, which in most cases are hollow. The drill bit is attached to the lower end of the drill stem and breaks up the material as it advances. Water or drilling mud is pumped down the drill stem to cool the bit. It also picks up the cuttings or drilling fines and carries them to the surface. The mixture of mud cuttings is discharged to a settling pit where the cuttings are removed and the drilling mud is recirculated. When the well hole is completed, the drill stem is withdrawn and the casing is put in place.

### **VERTICAL CASING ALIGNMENT**

It is important that the casing is in proper vertical alignment when it is installed. Even a slight misalignment may create stress on the pump shaft and bearings that can lead to mechanical failures. If a casing is misaligned, it may be necessary to install a submersible well pump instead of a line shaft pump. This may be the only solution to chronic line shaft failures in a misaligned casing. There are several

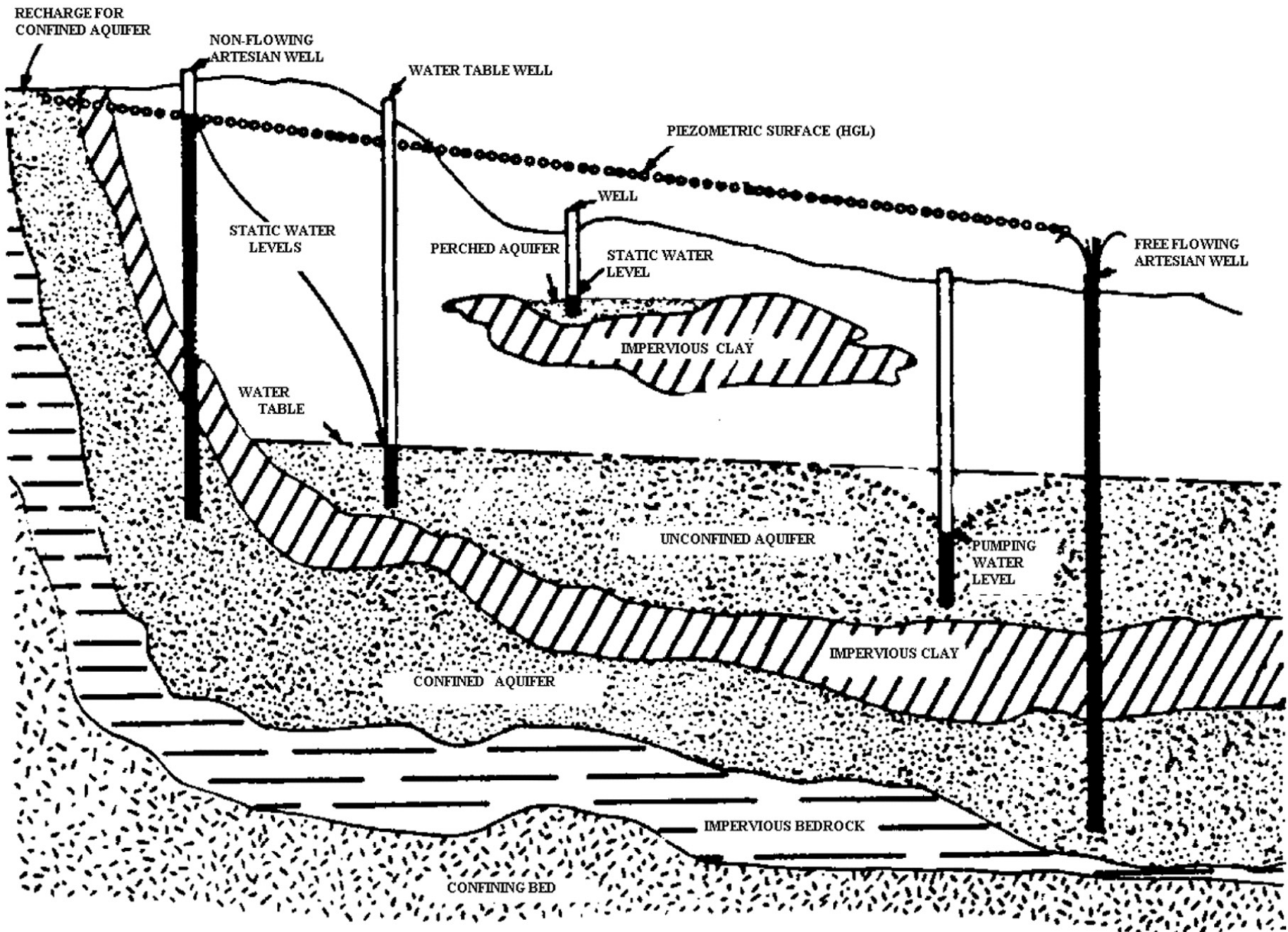

Figure 11.2 - Artesian & Water Table Aquifers

ways to check casing alignment. Down-hole TV inspection is popular because the condition of the casing and screen can be checked at the same time.

## SANITARY PROTECTION OF THE WELL

After a well has been drilled, care must be taken to prevent any surface contamination from entering the water supply. First, the casing is set to prevent the well from caving in or becoming contaminated from undesirable water sources located above the aquifer. The casing should be grouted with concrete on the outside to a depth of at least 50 feet or until an impervious layer of clay or rock is encountered. It may be necessary to grout deeper than this to seal off any undesirable water formations from the well. The depth of grout is determined by NMED on a case-by-case basis. In most instances, grouting will be required to extend to the water table. The grout must be pumped into the well from the bottom to the top. Otherwise, air will be trapped and prevent proper sealing of the cavity.

The casing should extend at least 6 to 12 inches above the well pad, depending on whether the well is located in a well house or out in the open, to prevent standing water from entering the well. The well pad should be sloped away from the casing. A sanitary well seal must be used to connect the well head and motor to the casing. Well seals are usually made of rubber or neoprene. A welded seal is also approved and used in some cases.

Well casing and discharge column pipe vents should extend at least 18" above grade. The outlets should be turned down to prevent rainwater from entering, and screened to

keep bugs out. Well housings should never be located in a pit. Abandoned wells should be plugged to a depth of at least 10 feet. In some states they must be completely cemented.

## DEVELOPING A WELL

Once construction is complete, the well is developed to remove the very small sand, shavings, and drilling mud from the surrounding aquifer. Two methods used to develop the well are surging and backwashing. Water is forced in and out through the screen as it flushes out the drilling mud and fine sand. Usually a pump much larger than the actual production pump is used. The well is pumped at the highest rate possible. This is done not only to remove the loosened mud but also to determine the well log data such as the yield, static and pumping levels, and specific capacity. The development of this data may require that this pumping rate be maintained for at least 8 hours.

It may take much longer to clear the well of drilling mud prior to disinfection. It is also important to determine the well recovery rate after the test is completed. The pump used to develop the well should never be the pump that is to be installed upon completion.

## GRAVEL PACKED WELLS

Wells that are located in fine sand formations, where sand pumping presents a problem, are usually gravel packed. If gravel packing is not used, the screen openings may have to be so small that the yield of the well is dramatically reduced. A layer of gravel is placed around the screen to hold the sand back and allow a larger well screen to be installed. The gravel packing is usually three times the diameter of the well screen or a minimum of 4" thick. The selection of the size of the gravel to be used depends upon the type of sand formation that is encountered and the type of screen that is being installed.

The gravel does not filter the sand. It is the increasing velocity, as the water gets closer and closer to the screen, which draws the sand into the well. The gravel pack holds the sand out away from the screen where the velocities are significantly lower than they are at the point where the water enters the screen. This minimizes the amount of sand that enters the well.

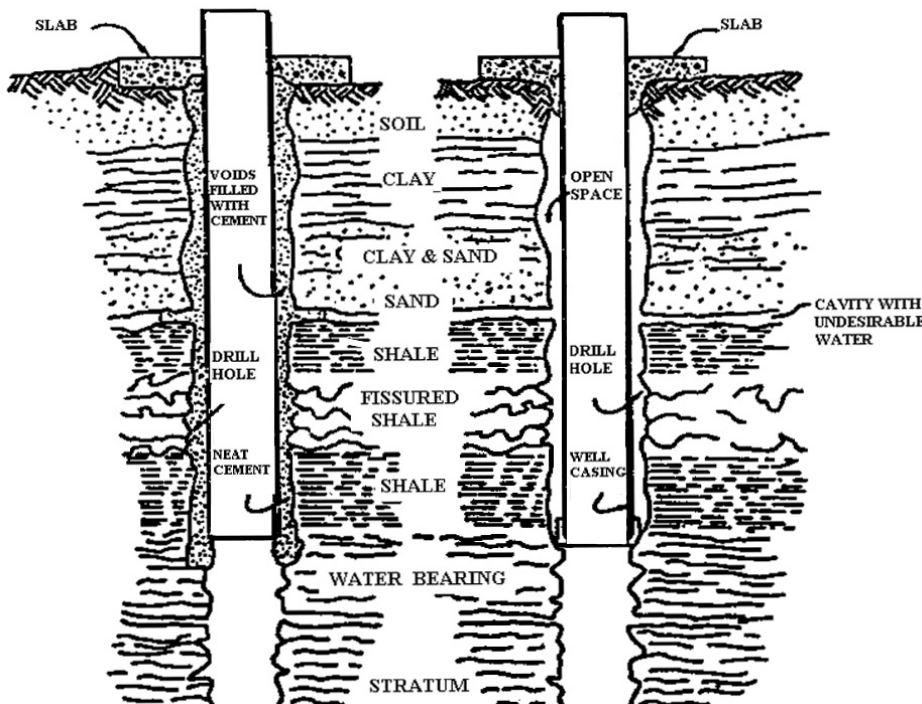

Figure 11.3 - Grouting A Well Casing

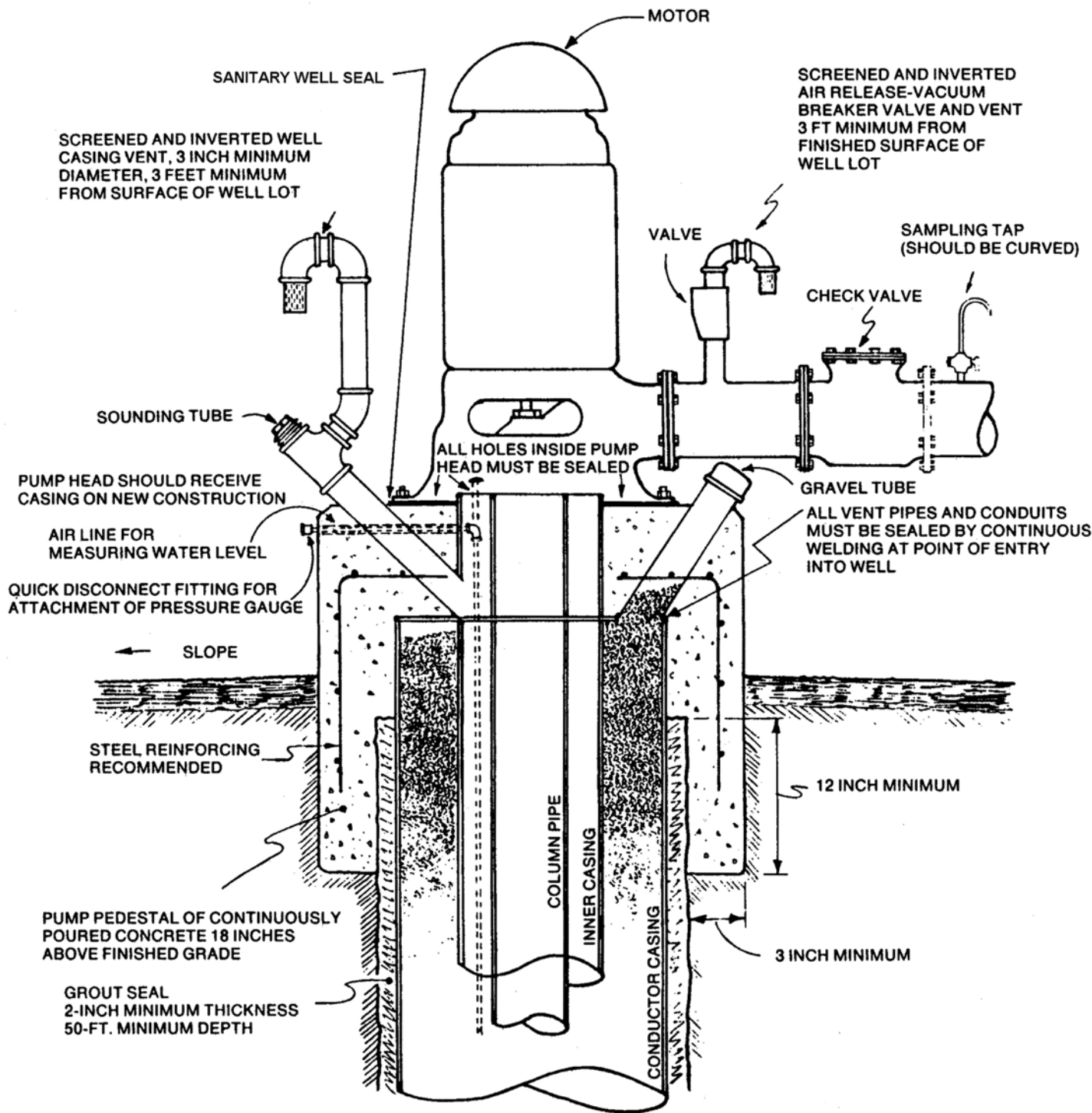

Figure 11.4 - Gravel Pack Well Construction

As sand is pumped out of the well, the gravel will fill in the cavity that is created and the gravel level will drop. This can result in exposing the well screen if gravel is not added periodically. The gravel is usually added to the well through a gravel packing pipe. This pipe is about usually 4 inches in diameter. The level of the gravel pack should be checked at least yearly.

Gravel should be cleaned and disinfected with a strong chlorine solution before it is added to the well. The level should be rechecked as the new gravel is added. Gravel should never be allowed to stand in the packing pipe. The vibration that is created when the pump is running can cause the gravel to compact and block the pipe.

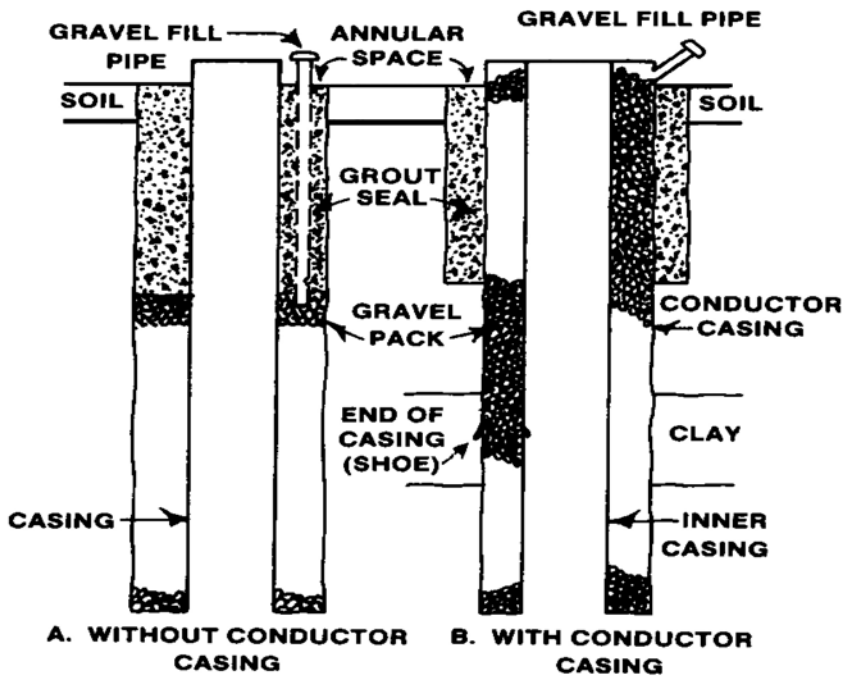

Figure 11.5 - Gravel Packed Well Types

## DISINFECTING WATER WELLS

The final step, prior to putting any new well, or old well that has had major cleaning or repair, in service, is disinfection and testing for bacteriological quality. The well should be flushed or redeveloped to remove drilling mud and debris prior to disinfection. (It is always easier to flush dirt out of the system than it is to burn it up with chlorine.)

Disinfection is achieved by the addition of a strong solution of chlorine to the well. The chlorine dosage should be at least 50 mg/l. If dosages in the range of 200-400 mg/l are added, less contact time will be required. The well should then be agitated periodically by surging. The contact time at a dosage of 50 mg/l should be 18 to 24 hours but at 200 mg/l only about 2 hours is needed. However, with longer contact times, the chlorine will move farther out into the surrounding aquifer.

The well should be flushed to remove the remaining chlorine once disinfection is completed. The bacteriological (Bac T) samples should then be taken from the well and submitted for testing. These samples must be taken daily until they are negative on two consecutive days.

## WELL PUMPS

Most well pumps that are installed in public water systems are vertical turbine centrifugal pumps. The main difference between vertical turbines and other types of centrifugal pumps is that the vertical turbine impeller discharges water out of the top of the impeller. This water flows upward along the pump shaft, instead of at a right angle to the

shaft. These pumps can generate the high discharge pressures needed to pump water several hundred feet out of the ground.

“Staging”, or stacking several impellers on the shaft, is how the high pressures are generated. As the water passes from the discharge of one impeller to the suction of the impeller above it, the pressure that the pump develops is increased. If five impellers that each generate 100 feet of head are staged in a pump, the pump will generate 500 feet of head pressure. Anytime pumps are operated in series, where one pump or impeller discharges to the suction of another pump; the pressure will increase while the flow remains constant.

In some very small, shallow wells airlift pumps may be used. These are normally not suitable for wells supplying most public water systems.

## VERTICAL TURBINE INSTALLATIONS

There are two kinds of vertical turbine pumps installed in wells. One of these is known as a submersible pump. A submersible pump will have the motor located beneath the pump. In a small well, it is the least expensive centrifugal well pump to purchase and install. Because there is no pump shaft running to the surface, the submersible is also the ideal pump installation in wells where vertical casing alignment problems exist. The biggest disadvantage of submersible pump installations is that the pump must be pulled from the well when the motor needs repair. Since this is usually the most common well type of repair for water wells, the cost of maintenance for submersible pumps is very high.

The other type of vertical turbine well pump is known as a line shaft pump. Line shaft pumps have the motor located on the well head. A line shaft runs down the discharge column pipe to the pump. The shaft is supported by line shaft bearings that center and stabilize the shaft in the column pipe. Line shaft pumps will cost more than submersible installations.

Vertical casing misalignment may make a line shaft pump installation impractical. The stress placed on the shaft and bearings can lead to chronic maintenance problems. The biggest advantage of a line shaft installation is that the motor can be repaired without pulling the pump and column pipe from the well.

## LINE SHAFT PUMPS

The line shaft must be supported to minimize vibration and radial (side-to-side) movement when the shaft spins. A line shaft bearing, also known as spider support or spider bearing, will be located in every section of discharge column pipe.

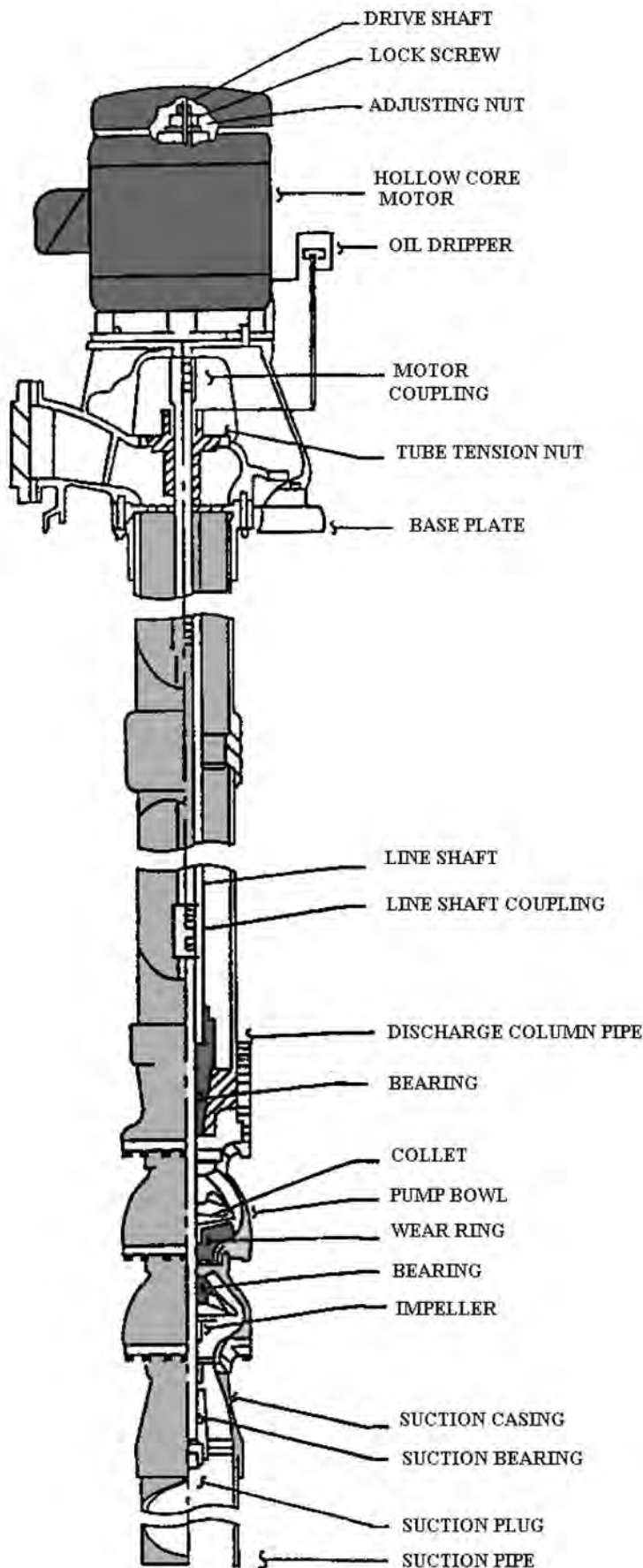

Figure 11.6 - Vertical Turbine Centrifugal Pump

Since column pipe sections vary in length from 12 to 20 feet, there are 5-8 bearings for every 100 feet of shaft. These bearings must be lubricated. There are two methods of lubricating line shaft bearings. One method utilizes water to lubricate the bearings while the other uses an oil-lubricated system.

### Line Shaft Bearings

Water lubricated line shaft bearings rely on the water that is pumped through the column pipe for cooling and lubrication. When the water table is very shallow, water in the column pipe will reach the bearing almost immediately. If the water table is deeper it can take several seconds for water to reach the uppermost bearings. If these brass or rubber bearings are allowed to spin for even a few seconds without lubrication they will fail prematurely. This type of installation will normally have some type of pre-lubrication system that allows water to run down the shaft and lubricate the top bearings before the pump starts. It may be set on a timer or it may drip continuously. Even with this type of pre-lubrication system, it is difficult to guarantee that all of the bearings that are located above the water table are properly lubricated before the pump starts.

Oil lubricated line shaft pumps are normally installed when water table depths exceed 100 feet. In an oil-lubricated system, the shaft spins inside a tube that is kept full of oil. The oil used in these systems must be EPA approved. These oils can be either vegetable or mineral based. Line shaft bearings are located inside the tube. Spider supports stabilize the tube inside the discharge column pipe.

### Oil Dripper Systems

Oil lubricated line shafts will usually be supplied with a dripper system to keep the shaft tube full of oil. The dripper system will consist of two dripper assemblies. One dripper will be setup to drip constantly and the other will be activated by a solenoid and will drip only when the pump is running. The solenoid-activated dripper will normally be supplied with a cooling water jacket that helps to maintain a constant oil temperature in the dripper.

The cooling water is needed because temperature fluctuations will cause the viscosity or thickness of the oil to change. As the viscosity changes the drip rate will also change. The effect that these changes will have on the drip rate must be taken into consideration when the drip rate is adjusted. The drippers should be checked and adjusted at least twice a year, in the early summer and early winter.

### Adjusting Dripper Systems

The constant dripper should be adjusted when the well has not been running for several hours. The oil temperature will be about the same as the ambient air temperature. This is the situation most of the time that the constant dripper is needed. If it is set in the summer and not checked again when it turns cold in the winter, the drip rate will be much lower as the oil temperature drops and the oil becomes thicker. The constant drip rate should be set at 1 drip/minute.

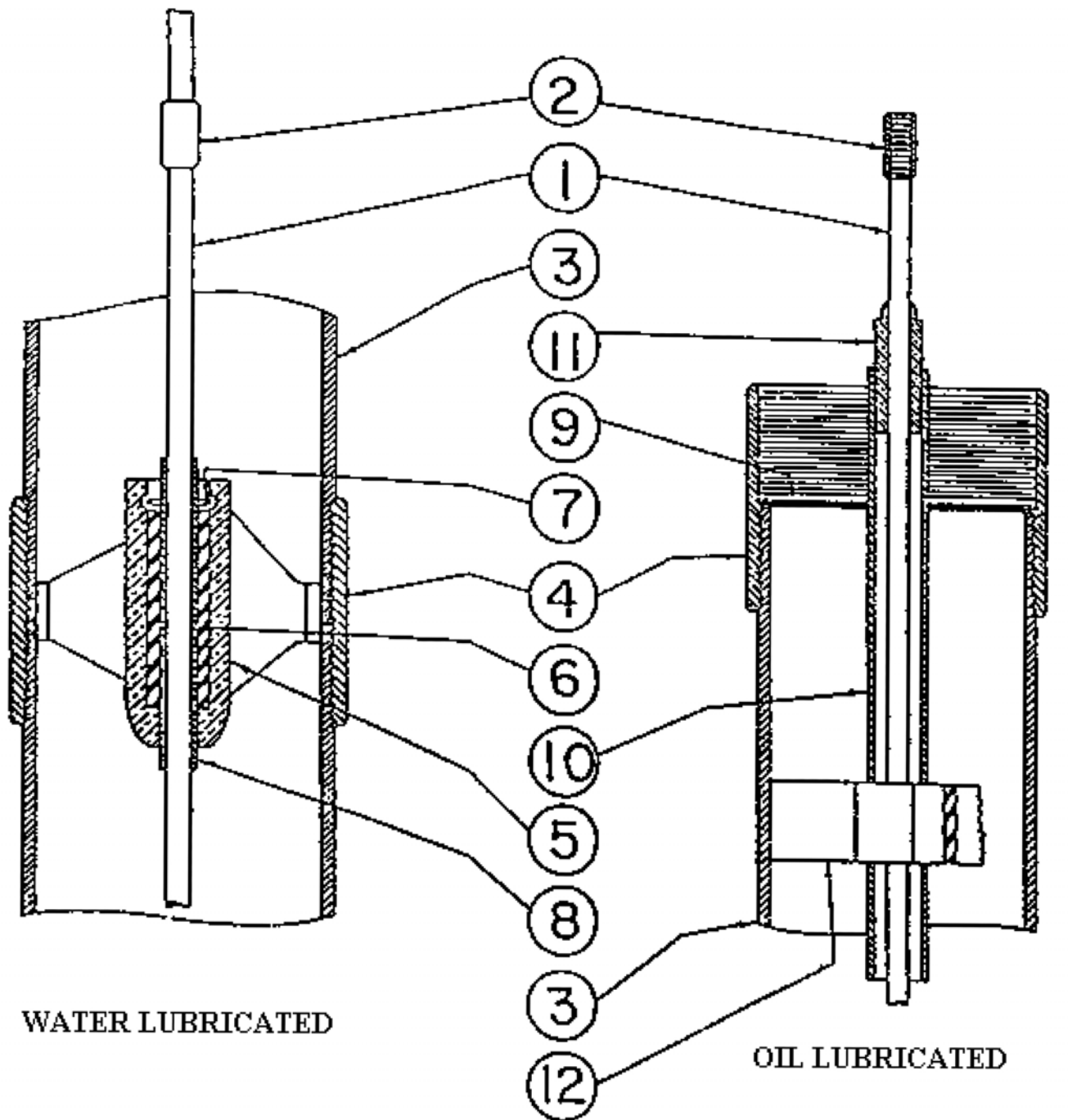

WATER LUBRICATED

OIL LUBRICATED

- |                                 |                               |
|---------------------------------|-------------------------------|
| 1 - Line Shaft                  | 7 - Snap Ring                 |
| 2 - Shaft Coupling              | 8 - Shaft Sleeve              |
| 3 - Column Pipe                 | 9 - Column Pipe Spacer Ring   |
| 4 - Column Pipe Coupling        | 10 - Oil Tube                 |
| 5 - Stabilizer Support (Spider) | 11 - Line Shaft Bearing       |
| 6 - Rubber Shaft Bearing        | 12 - Tube Stabilizer (Spider) |

Figure 11.7 - Shaft Lubrication Systems

The automatic dripper should be set after the well, and dripper-cooling water, has been running for an hour or so. If the drip rate is set when the well is not running and the oil temperature is higher, the drip rate may be too low when

the cooling water lowers the oil temperature. In most wells, the automatic drip rate should be set at 6-10 drips/minute. Wells over 500 feet deep may require drip rates of up to 18 drips/minute.



## WELL SCREENS

There are several types of well screens that can be installed in most wells. They range from well casing that is perforated on-site with a cutting torch to continuous-slot well screens made of steel or sometimes plastic strips that are wrapped around a wire cage. Louvered or perforated casing is also used in many installations. Continuous-slot screens are the most expensive and generally considered to be the best choice because of the low friction loss encountered as the water enters the well. These screens typically have openings that are equal to 40-50% of the total surface of the screen.

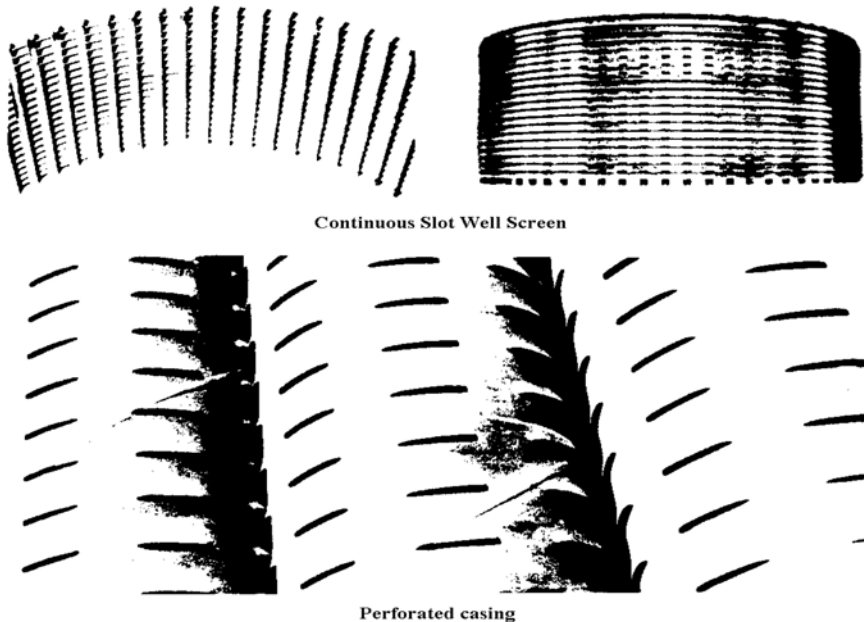

Figure 11.8 - Well Screens

## WELL HYDRAULICS

The amount of water a well will produce depends mainly on the type of aquifer, well construction, and the depth of the zone of saturation. The annual recharge rate from percolation, along with the ability of the water bearing formation to transmit water to any given point, will also influence well production. The performance of a well can be determined by taking readings of the hydraulic conditions. An operator must be familiar with these terms and definitions\*, in order to accurately troubleshoot problems that may be discovered.

- **Static level** is the water level in a well when the pump is not operating.
- **Pumping level** is the water level in the well when it is producing.
- **Drawdown** is the difference in elevations between the static level and the pumping level. The amount of water produced is approximately proportional to the

drawdown. For example, increasing the yield by 10% will increase the drawdown by 10%. The drawdown that occurs when a well is running is roughly equal to the head loss encountered in moving the water into the well. Water bearing formations of gravel, limestone and coarse sand will usually provide more water with less drawdown than formations containing fine sand or clay.

- **Specific capacity** is the relationship between the yield of a well and the amount of drawdown in the well. It can be expressed as a ratio of the yield, in terms of gallons per minute, to the drawdown in feet. A well producing 100 gpm with a drawdown of 20 feet would have a specific capacity of 5 gpm per foot of drawdown.

$$\frac{100 \text{ gpm}}{20 \text{ feet}} = 5 \text{ gpm/foot}$$

In this particular case every time the yield is increased by 5 gpm the drawdown will increase by one foot. This relationship will exist until the yield exceeds the aquifer's ability to deliver water to any single point. When this limit is reached, the drawdown increases dramatically with little or no increase in the yield.

- **Cone of depression** is directly related to the drawdown in the well. As the pump draws down the water level, a portion of the aquifer surrounding the well is drained of water. A cone shaped depression is formed in the water table around the well. The shape of the cone will vary depending on the type of formation in which the well is located. A fine sand formation will usually create a steep cone of depression, while a shallow cone is usually found in coarse sand and gravel formations.
- **Radius of influence** is the farthest distance from the well that the cone of depression affects the water table. This distance can be determined by sinking test holes around the well and monitoring the water levels in them while the well is pump-ing.
- **Recovery time** is the amount of time required for the aquifer to stabilize at its static water level once pumping has stopped. This can also be determined by monitoring the water levels in the test holes used to determine the radius of influence.

\*See Figure 11.9 for an overview of the preceding Water Well Hydraulic Terms.

# Water Well Hydraulic Terms

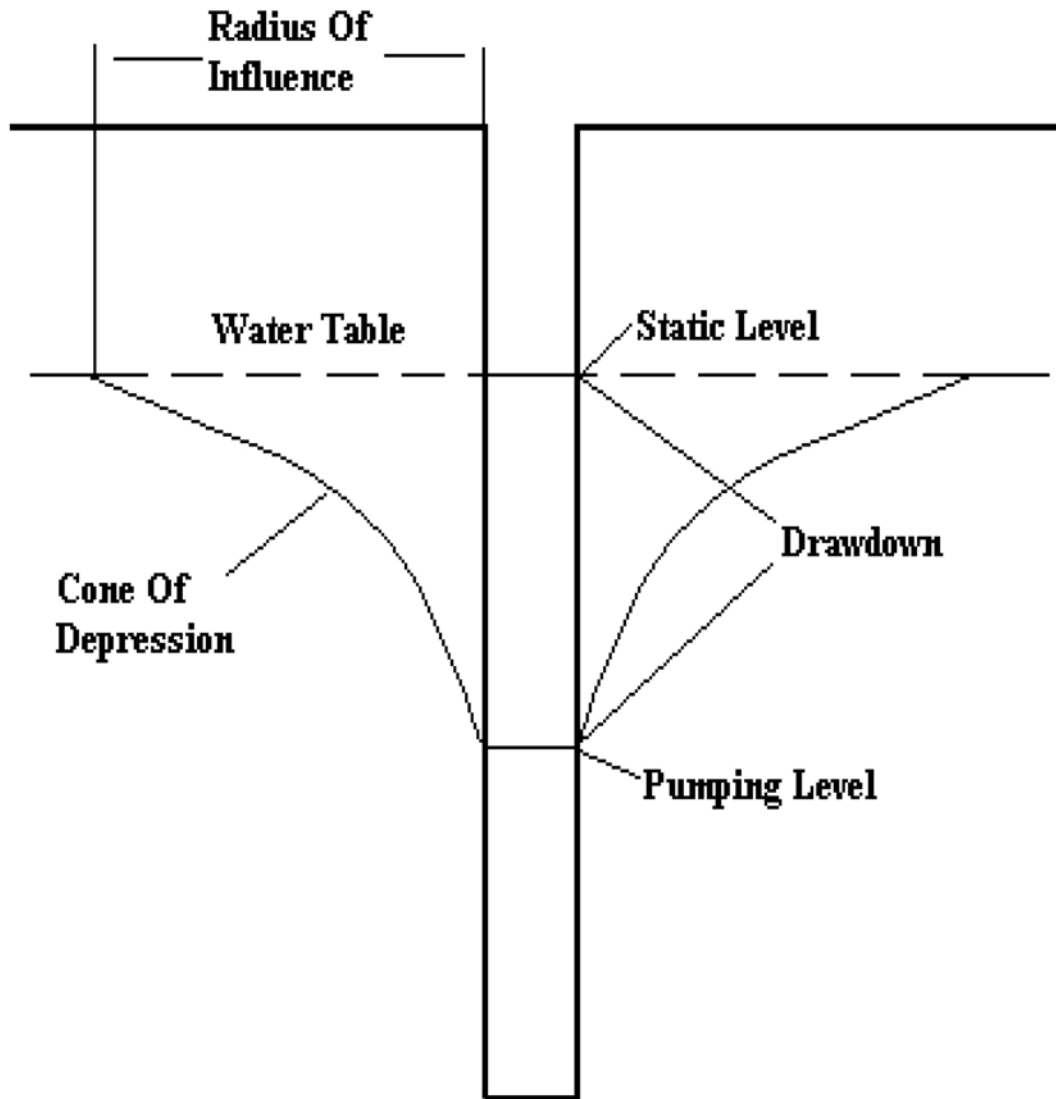

Figure 11.9 - Water Well Hydraulic Terms

## MEASURING STATIC AND PUMPING LEVELS

Several methods can be used to determine the elevation of water in the well. This can be accomplished by lowering some type of measuring device that can locate the water level, into the well casing through a sounding tube (sometimes called a drawdown tube). A chalk line can be used if the approximate level is known. The bottom five to ten feet of the line is chalked and then lowered into the well to the estimated water level. The amount of line that is wet (easily identified by the wet chalk) is subtracted from the total amount lowered into the well to accurately locate the water level.

Another device that is used to determine water levels consists of an electrode attached to a cable and connected to a DC power supply. This type of device is sometimes referred to as an "M-scope." The electrode is lowered into the well casing until it contacts the water surface. Contact

with water closes the electrical circuit and lights an indicator lamp on the power supply. The length of the cable that is in the casing is measured to determine the water level. The biggest disadvantage to using this type of "sounding" device is that the cable may wrap itself around the column pipe, making removal a real problem.

Another effective method of determining these levels involves using an air line. The air line is installed inside the casing and extends down to a point just above the bowls of the pump. A pressure gauge, installed at ground level, and an air pump (bicycle or hand pump) are all the equipment that is needed. The length of the air line must also be known in order to use this method.

As air is pumped into the line, the pressure gauge reading will begin to increase. When the pressure reading no longer rises, all of the water has been forced out of the pipe by the

air. This gauge reading will represent a column of water the same height as the distance the line extends below the surface of the water. Subtracting this distance from the total length of the line will locate the elevation of the water in the well. The gauge reading may be used directly if the gauge is cali-brated in feet of head. If the gauge reading is in pounds per square inch (psi), it must be multiplied by a factor of 2.31 ft/psi before being subtracted from the length of the air line. As an example, the air line is 300 feet long and the gauge reading is 100 feet of head when the pump is not running:

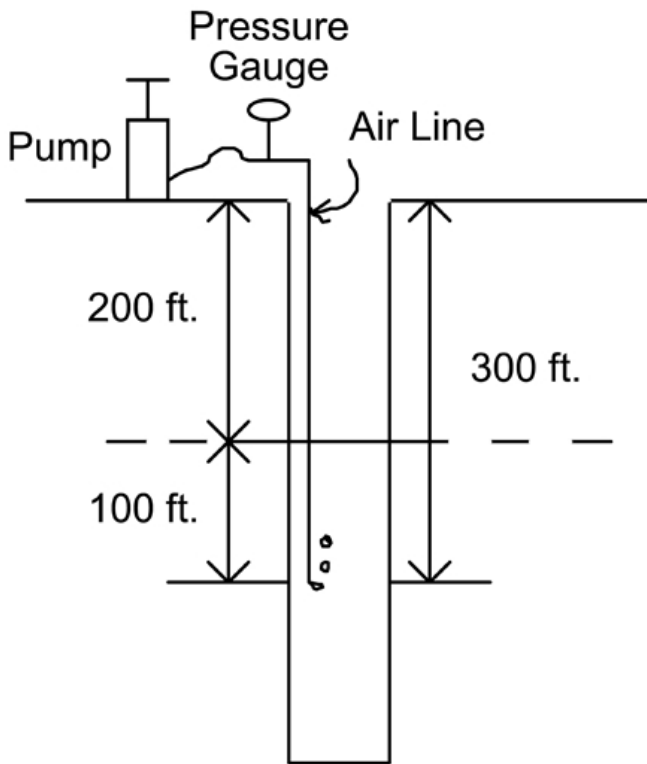

$$300 \text{ ft. (air line)} - 100 \text{ ft. (head)} = 200 \text{ ft. to the water}$$

**Figure 11.10 - Measuring Static & Pumping Levels**

The static level is determined after the pump has not been running for several hours or overnight. The pumping level should not be determined until the well has been pumping long enough to insure that the pumping level has stabilized. It could take from 30 minutes to several hours to stabilize the pumping level.

## THE WELL LOG

When the contractor is developing the well, information about the well is being recorded for the well log. Table 11.1 shows the information that a well log will contain.

The well log is essential for troubleshooting well operational problems. It represents how the well should perform when

**Table 11.1 - Well Log Data**

- Depth of the Well
- Length of Screen
- Pump Setting
- Yield
- Static Water Level
- Pumping Water Level
- Drawdown
- Specific Capacity
- Other Geological Data Regarding the Aquifer

everything is working right. Without this data it is very difficult to determine what, if anything, is wrong with current the well performance. If a well is over 20 years old, there is a good possibility that the well log can't be located. This is no reason to panic yet. Contractors are responsible for filing a copy of every public water supply well log with the State Engineer's Office. Copies of well logs can be obtained by contacting the State Engineer. Information on surrounding wells may also be obtained to assist in gathering data used to locate new wells.

## TROUBLESHOOTING WELL PROBLEMS

There is little information that can be gathered that will indicate how a well is performing. Changes in the static level, the pumping level or the yield of a particular well will generally indicate a problem has developed. In addition to this information, the current draw (amps) on the motor is the only other indicator poor well performance. It is important to check static and pumping levels periodically to prevent any problems that may develop from be-coming serious. The well log is used as a reference for each set of readings. Anytime there is a well problem, both the yield, and the specific capacity will be reduced.

### WELL RELATED PROBLEMS

Let's take a look at the example illustrated in Figure 11.11. From the well log and current measurements it has been determined that the static level has remained the same but the pumping level has dropped several feet.

Under these conditions it should be noted that the drawdown has increased. The drawdown is equal to the head loss encountered in moving water into the well. Since the drawdown has increased, there is more head loss now than when the well was new. It is unlikely that the conditions in the aquifer have changed. Therefore, the well screen must be getting clogged.

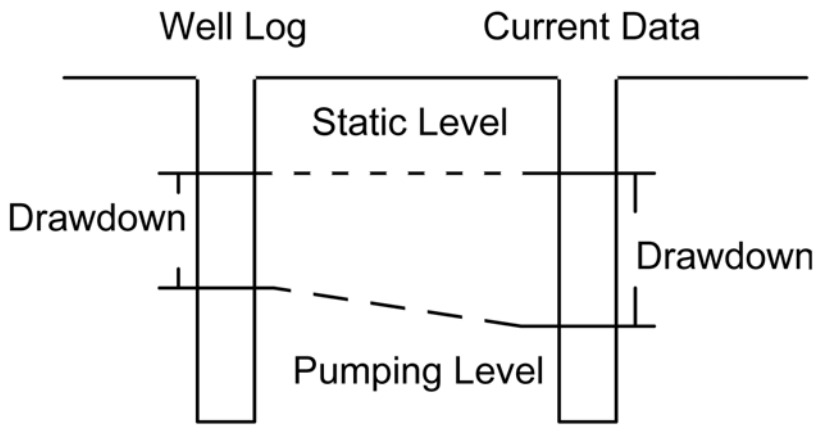

**Figure 11.11 - Well Problem - Clogged Screen**

**Clogged Well Screens**

There are several ways that a well screen can become clogged. The most common cause is chemical scaling or lime encrustation on the screen. Newer wells may develop a condition called “sand bridging.” Another possibility is clogging due to iron bacteria colonies that are growing on the screen.

**Sand Bridging**

Sand bridging is a condition that is normally only found in new wells. It occurs when sand, drawn toward the well, blocks the screen by forming an arch across the openings.

Sand bridging is usually a result of improper development of the well or inadequate gravel packing. Surging water through the screen may break up the bridging. If surging doesn't work, it may be necessary to pull the pump and mechanically clean the screen with high-pressure jets to correct the condition. The well should be re-developed before replacing the well pump.

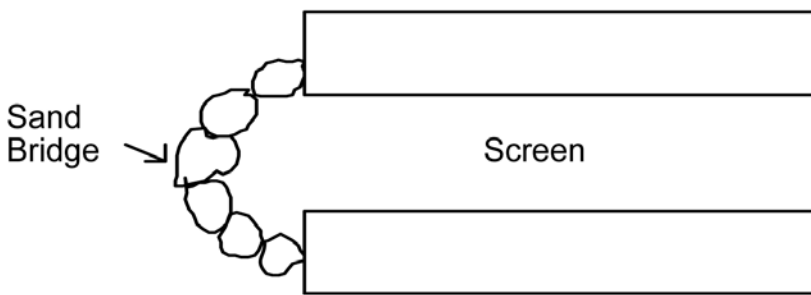

**Figure 11.12 - Well Problem - Sand Bridging**

**Iron Bacteria**

Clogging caused by iron bacteria is a problem for many wells in the Southwest. If the well has been in service for several years, and the water supply is low in alkalinity and corrosive, there is a good possibility that the clogging is a result of the build up of iron bacteria colonies on the screen. Iron bacteria feed on the iron that is naturally present in some supplies. They will attach themselves to iron and steel

screens and a colony of the bacteria will begin to grow. Clogging caused by iron bacteria is very difficult to remove. Chemical treatment with massive doses of chlorine (200-300 mg/l) followed by surging or even mechanical cleaning may be the only means of clearing clogged screen openings. Even then, it is unlikely that the entire colony has been removed. The remaining bacteria will begin to grow, causing a recurrence of the problem. Wells with iron bacteria should be treated with chlorine periodically to inhibit the regrowth for as long as possible.

**Lime Scaling**

Lime scaling is most likely to occur when the water contains high amounts of alkalinity and hardness. Like iron bacteria, lime scaling will tend to be a chronic problem where the conditions that promote its formation exist. There are several ways to clean a screen of lime scale.

**CLEANING INCRUSTED WELL SCREENS**

Well screens that are clogged with scale can be cleaned using one of several techniques. The four most commonly used methods are listed below:

1. **Surging** water through the screen may break up loose scale that is just beginning to form. This is accomplished by starting and stopping the pump to allow water in the column pipe to fall back into the well and create a surge out through the screen. This is sometimes taken a step further by holding the check valve open when the pump is stopped so that more water will rush down the well and out into the surrounding aquifer. In order for this method to be effective, the condition must be identified before the scaling becomes very severe.
2. The **percussion** method may be the most dangerous method of cleaning a well screen. It involves the detonation of some type of explosive within the well casing. The theory behind this process is that the explosion will create shock waves that will vibrate the screen enough to shake the scale loose. This is sometimes accomplished by firing a blank down the well. This is only effective in very small, shallow wells where there is not much water standing above the clogged screen.

In most public supply wells a larger charge is needed, and it is usually placed down the well in the vicinity of the screen. Blasting caps and primer cord are the most common explosives used in these situations. In addition to the obvious dangers involved in handling these types of explosives, the possibility for damaging the well screen also exists.

- The **acidizing** method will clean all but the most severely scaled screens. Acid is poured down the well casing and allowed to stand for 8 to 12 hours. The acid will react with the lime and dissolve the deposits on the screen. The well is then surged to help loosen the remaining scale and flushed.

**Always use inhibited acid!** Inhibited acid is chemically weakened. In this weakened state it will dissolve the lime without attacking the screen or pump parts. There are inhibited acids available in solid forms, sulphamic acid for example, that can make the acidizing process much easier and more effective. The pelletized acid can be poured into in casing where it will sink to the bottom of the well and dissolve in the area of the screen.

- Mechanical cleaning** may be the only method that is effective in situations where severe clogging exists. Mechanical cleaning will require the removal of the pump from the well. The screen will be cleaned using a larger wire brush or high-pressure water jets and then bailed to remove the debris that is knocked loose. In extreme cases, the screen may have to be pulled and cleaned or replaced. Not only is this very expensive, but it can also result in the collapse of the gravel pack around the screen. Anytime the pump is pulled from the well and maintenance is performed, the well must be disinfected prior to being put back into service.

If the impeller clearance is properly set, the only other cause of this type of condition is some type of mechanical problem with the pump or line shaft. Mechanical problems will require pulling the pump, so the first step in troubleshooting this situation is to adjust the impeller clearance. Adjusting the impeller clearance is also referred to as adjusting the “lateral setting” or “setting the stretch” on the pump.

#### ADJUSTING IMPELLER CLEARANCE (LATERAL SETTING)

When the pump is operating, the proper clearance between the wear rings and the impeller should be between 1/32-1/4" (depending on the impeller design). Wear rings, as the name implies, are designed to eventually wear out. The clearance between the impeller will increase as wear occurs. Specific adjustments can be made to raise or lower the impellers and bring the clearance back within acceptable tolerances.

Line shaft stretch must also be taken into account. Even though the shaft is made of hardened steel, it will stretch under load. There are several factors that will determine how much the shaft will stretch. See Table 11.2.

**Table 11.2 - Forces That Cause Shaft Stretch**

- 
- **The Weight of the Shaft**
  - **The Weight of the Impellers**
  - **The Downthrust Exerted Against the Impellers**
- 

### PUMP RELATED PROBLEMS

From the well log and current measurements, it is determined that the static level is the same, but the pumping level has risen several feet. Water production from the pump has also decreased. This reduced drawdown and yield from the well indicates a problem with the pump.

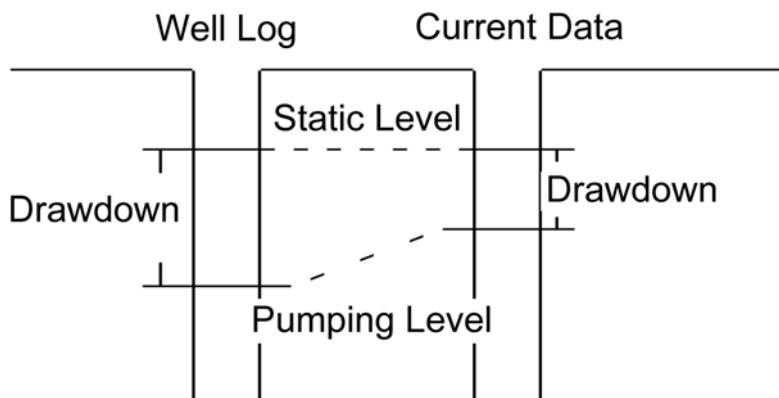

**Figure 11.13 - Well Problem - Mechanical Pump**

The most common means of raising and lowering the shaft is by adjusting the top shaft nut or adjusting nut, located on the top of a hollow core motor. The rotor in a hollow core motor is hollow and the pump shaft can slide up and down through the rotor. The adjusting nut prevents the shaft from slipping down through the motor. Tightening and loosening the top shaft nut will then raise and lower the pump impellers. Smaller shallow wells may not have hollow core motors. If this is the case, the adjustment is made at a special motor coupling or by shimming the motor. After a lateral adjustment is complete, motor amps can be used as a tool to check the adjustment.

When the drawdown and pump production have both decreased, it usually means the pump efficiency is reduced. The most common cause of this problem results from the clearance between the impeller and the pump bowls being too wide. Water will begin to slip around the impeller instead of being pumped out of the well.

Table 11.3 - Well Troubleshooting Flow Chart

## WELL TROUBLESHOOTING FLOW CHART

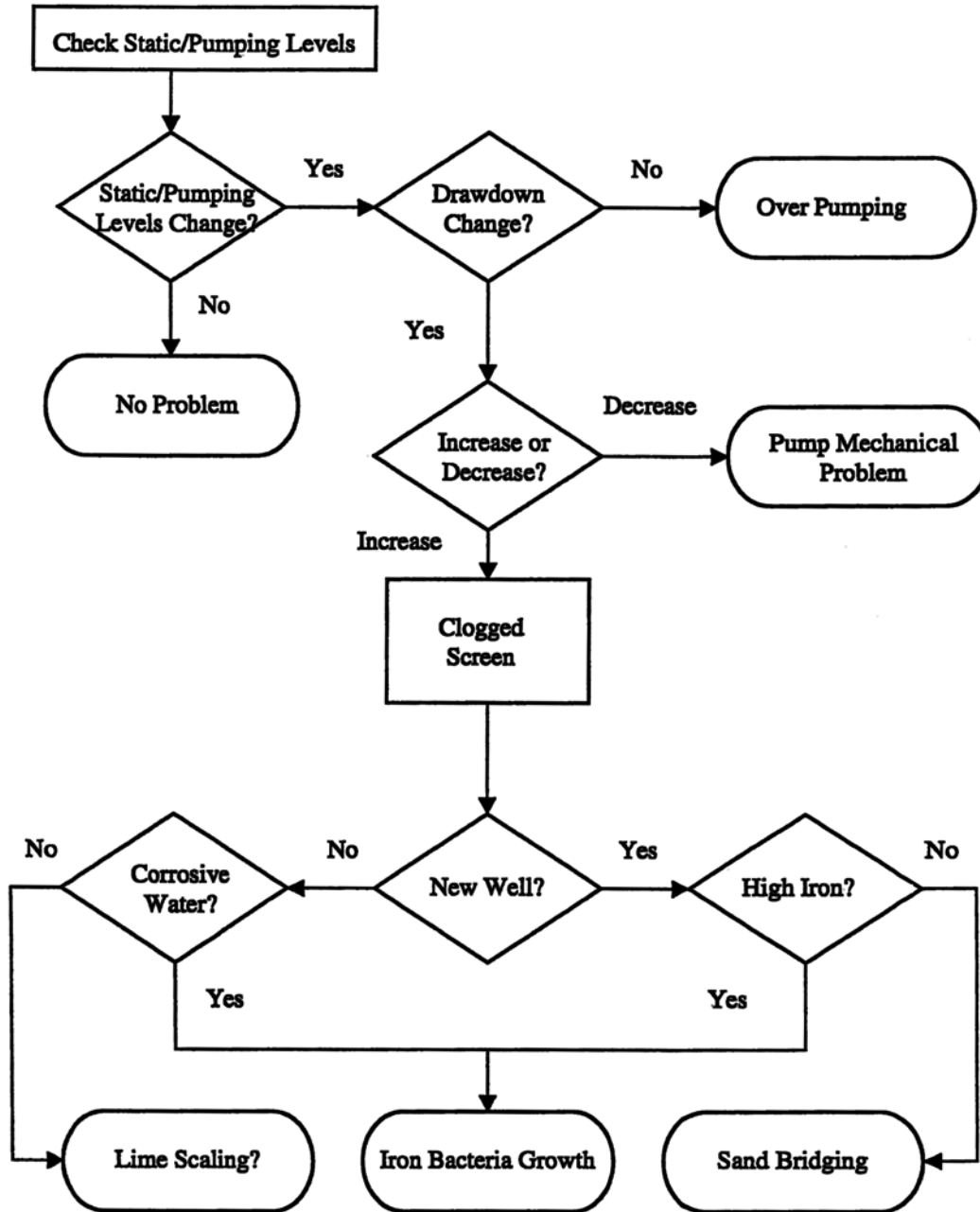
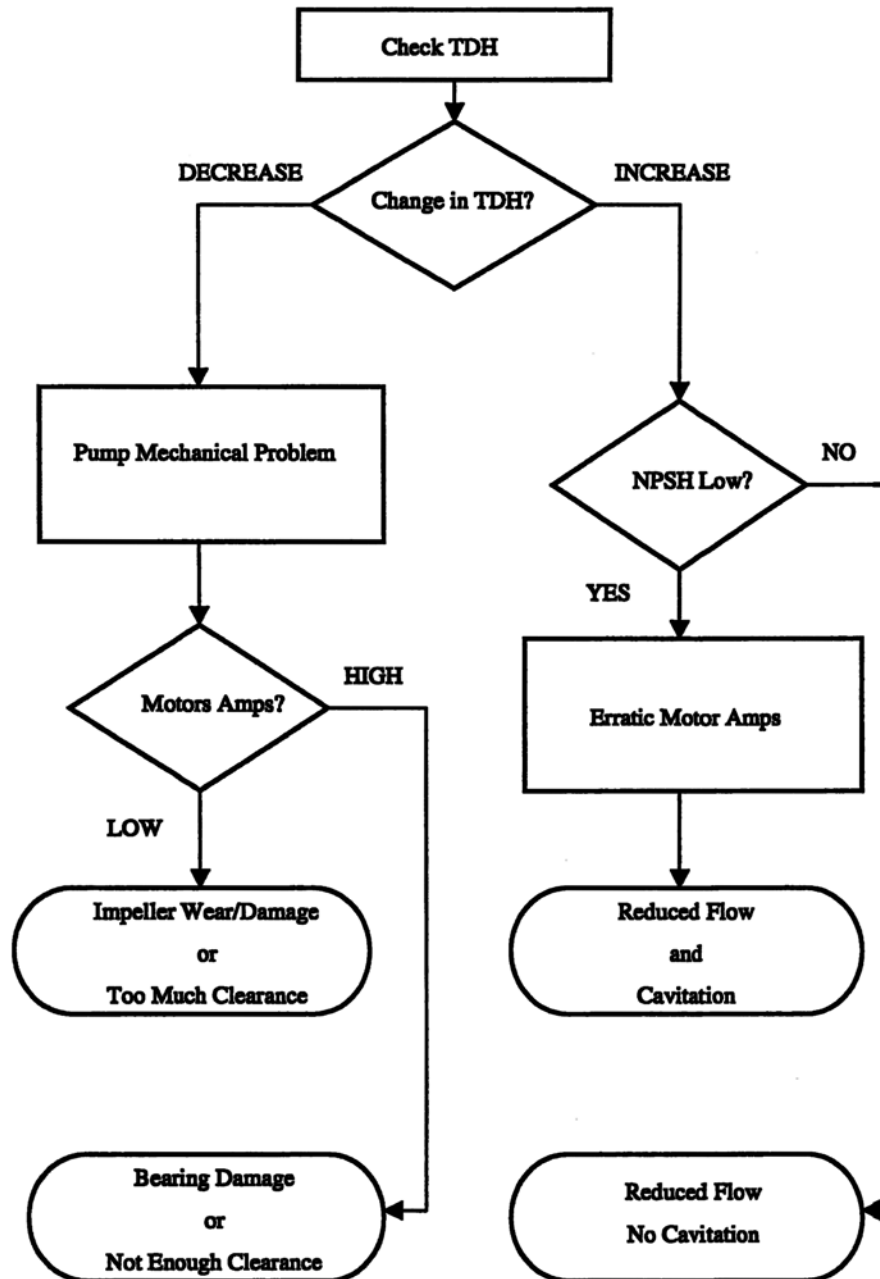

Table 11.4 - Troubleshooting Well Pumps

## TROUBLESHOOTING WELL PUMPS



---

## References

Office of Water Programs, California State Univ. Sacramento, *Groundwater & Wells*, 2<sup>nd</sup> ed., Chapters 4, 10, 15, 17, & 19.

Office of Water Programs, California State Univ. Sacramento, *Small Water System O&M*, 4<sup>th</sup> ed., Chapters 3 & 19.

---

### BASIC STUDY QUESTIONS

1. What is meant by the term percolation?
2. What is the primary reason for grouting a well casing?
3. What is the drawdown in a well?
4. What are the requirements for disinfecting a well?
5. Which type of well pump will help minimize the problems caused by well casing misalignment?

### BASIC SAMPLE TEST QUESTIONS

1. The distance from the well to the edge of the cone of depression is:
  - A. Drawdown
  - B. Radius of influence
  - C. Infiltration
  - D. Zone of saturation
2. If the drawdown increases, the screen is becoming clogged.
  - A. True
  - B. False
3. Sand production is usually at highest
  - A. During startup
  - B. After it has run for several hours
  - C. When there is a pump-related problem.
  - D. All of the above
4. Which of the following does not provide contamination protection for a well?
  - A. Grout
  - B. Well pad
  - C. Motor coupling
  - D. Sanitary seal

### ADVANCED STUDY QUESTIONS

1. What are the limitations for water lubricated line shafts?
2. Why a gravel pack used in wells?
3. What is specific capacity?
4. Public wells should be located how many feet from potential pollution sources?
5. What should be done when treating a well for iron bacteria?

### ADVANCED SAMPLE TEST QUESTIONS

1. If the pressure gauge on an air line reads 25 psi and the air line is 400 feet long, how far is it to the water level?
  - A. 25 feet
  - B. 58 feet
  - C. 342 feet
  - D. 375 feet
2. The friction loss on the suction side of the well pump is equal to:
  - A. The drawdown
  - B. The specific capacity
  - C. The pumping level
  - D. The lateral setting
3. When the drawdown in a well increases:
  - A. The screen is clogged
  - B. The pump impellers may be worn
  - C. The specific capacity increases
4. The drawdown in a well has decreased and the motor amps are high. The most likely problem is:
  - A. The screen is clogged
  - B. The pump impellers are worn
  - C. The line shaft bearings are failing
  - D. The TDH has increased



## CHAPTER 12: SURFACE WATER

---

Water that is taken from lakes, rivers, or impoundments is known as surface water. Many large systems make use of surface supplies because these rivers and lakes offer storage of large amounts of water. The chemical characteristics of surface water differ from ground water in several ways and generally require a greater degree of treatment to meet the Drinking Water standards. The minimum treatment required for surface water is filtration and disinfection.

As ground water percolates through the soil, the natural filtering action removes much of the material responsible for turbidity in surface waters. This filtration and the tremendous retention time in the aquifer provide for the removal of many of the bacteria in ground water. The mineral content of the ground water may be greater than that of surface water. These minerals are dissolved in the water as it percolates through the soil.

Some systems that were once considered groundwater are now defined as “groundwater under the influence of surface water” by the amended SDWA regulations. These systems must now treat their water like other surface supplies and filter and disinfect. Surface or boxed springs are now considered to be surface water supplies. Infiltration galleries are also considered surface supplies. These wells are located so close to a river or stream that the water in the surface supply percolates directly into the wells because the radius of influence overlaps the riverbed.

Surface waters will generally have more bacteria and turbidity present than ground water. Taste and odor problems are usually greater in surface water due to algae, bacteria, and fungi that are present in the water. Ground water may also have taste and odor problems that are usually caused by hydrogen sulfide gas and minerals like iron.

### SURFACE WATER SOURCES

#### LAKES AND RIVERS

There are certain advantages and disadvantages related to taking water from rivers or lakes. Lake supplies maintain a more constant quality of water. The turbidity, temperature, and pH do not fluctuate as much from day to day as a river supply. Minerals tend to concentrate in lakes. Iron, manganese, and other dissolved metals are retained in the lake with the highest concentration being found near the bottom. This occurs due to the lack of dissolved oxygen at the lower depths. The dissolved oxygen from wind and algae growth near the surface will oxidize some of the dissolved

metals so that they precipitate. The length of detention time in the lake aids in the natural bacteria removed. The detention time also aids in the natural removal of suspended material or turbidity by sedimentation.

The quality of the water in lakes is affected by an occurrence known as “Turnover.” This happens once or twice a year, generally in the springtime, as the water temperature of the lake begins to change. The density or “Specific Gravity” of the water changes as the water temperature changes. Water is heaviest or most dense at 4 degrees Centigrade or about 39 degrees Fahrenheit. In a deep lake the water at the bottom will always be about 4 degrees C because of its higher Specific Gravity. Stratification occurs as layers of water at different temperatures form in the lake. In the spring as ice on the surface melts, it becomes warmer (and heavier) and begins to sink. As this happens water at the bottom is forced to the surface. This mixing action stirs up silt and decaying organic material and as a result can cause serious taste and odor problems. In the late fall as water at the surface cools it also gets heavier and sinks to create the same situation. Changes in water temperature and density also affect chemical treatment and settling in surface water treatment plants.

The turbidity, temperature and pH of water taken from rivers may fluctuate on a daily, or sometimes on an hourly basis. Rainfall and run-off usually contribute to these changes. Changes in the quality can also result from waste discharged from upstream sources. Minerals do not accumulate in rivers as they do in lakes. Mainly, because any water that is not used is carried downstream rather than being retained as it is in a lake. Jar testing should be done when the raw water quality changes. A jar test will help the operations staff determine what adjustments must be made in the treatment process when these changes occur.

### INTAKE STRUCTURES

The type and location of the intake structure in the surface supply will determine the kind of treatment necessary for production of potable water. Ordinances should be passed to protect the water around the intake structure. Boating, swimming, and fishing should be discouraged in the area of the intake. Floating buoys should be placed as markers around the intake structure.

The intake structure should be designed to prevent the structure from freezing in the winter. Proper screening of the intake is also required to protect pumps and valves from serious damage. Periodic maintenance should be performed

to keep screens from clogging and clear of restrictions. In some systems this is accomplished by flushing or backwashing the screen with water pressure supplied by a backwash water line located within the structure. Water is forced through the screen, washing the debris away from the structure.

### RIVER AND STREAM INTAKES

The most common type of intake in flowing water is a simple pipe extended into the water. This pipe or intake line feeds water to low service pumps usually located in a pump house on the bank. Provisions should be made to prevent floating material from clogging the intake screen. Intake screens should be small enough to prevent clogging and large enough to allow adequate intake flow. The intake line should be located perpendicular to the flow or at a forty-five degree angle downstream. Intake lines that are pointed directly downstream may experience problems during high flows. A low-pressure area will develop around the intake restricting the flow of water into the structure. The intake pipe should be elevated off the bottom to avoid heavy concentrations of sand, silt and dissolved minerals.

### LAKE AND RESERVOIR INTAKES

Intakes in lakes and reservoirs are generally located in 15 feet or more of water to provide multiple intake levels. These inlets are usually located 4 to 6 feet from the surface and at 5 to 10 feet intervals depending on the depth of the

water. This will allow the operations staff to select water from different levels in the lake and minimize treatment costs by obtaining the best quality raw water. Inlets should never be located near the bottom of the lake to avoid high concentrations of dissolved minerals and gases, turbidity, and tastes and odors. Inlets are controlled by gate valves and operated from the top of the intake structure. These gate valves should be operated periodically to keep the valve in good working order.

### SURFACE WATER QUALITY

The type of treatment needed for surface water supplies depends on the contaminants present. These contaminants are grouped into five general categories: minerals, turbidity, bacteria, tastes and odors, and color. Before treatment processes can be discussed, the contaminants associated with each of these groups must be identified.

### MINERALS

The mineral problems in water are caused by inorganic contaminants. These are usually dissolved metals and dissolved gases. Some of the more common mineral problems include iron and manganese, famous for causing “red water” problems, and hardness. Carbon dioxide gas can cause corrosion problems and hydrogen sulfide gas is noted for the “rotten egg” odor that is sometimes found in water. All of the inorganic chemicals are listed under the SDWA Primary and Secondary standards are also included in this category.

### TURBIDITY

Silt and clay are primarily responsible for the turbidity in water. However, any suspended material that will not readily settle is considered to be turbidity. Some clay particles are so small that they will not settle at all. These particles in suspension are known as “colloids.” Most turbidity particles carry a slight negative electrical charge that causes them to repel each other. Zeta Potential is the term used to identify this electro-chemical repulsion. The treatment to remove these particles must neutralize these charges and bring them together until a particle is formed that is large enough to settle.

### BACTERIA

Bacteriological contamination has been covered in a previous chapter. It should be noted at this time that the presence of turbidity in the water could affect the disinfection process. A clump of turbidity can “hide” bacteria. This greatly reduces the

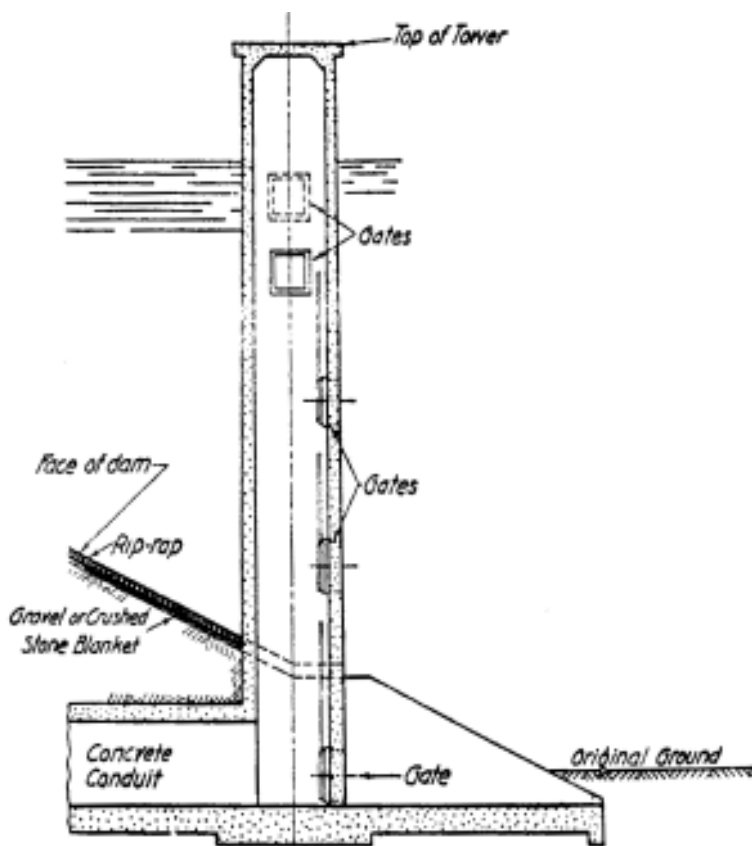

Figure 12.1 - Lake Intake Structure

effectiveness of the disinfectant and is the main reason turbidity is a primary contaminant in the SDWA. The possible presence of *Giardia* or *Cryptosporidium* can affect treatment strategies due to the need for higher free residuals and extended contact times.

### TASTES AND ODORS

The main source of taste and odor problems in surface supplies is algae (small floating water plants). These are organic compounds that impart a mossy or fishy odor. The most common source of taste and odors in ground water supplies are inorganic chemicals. Hydrogen sulfide gas ( $H_2S$ ) causes a “rotten egg” odor. Iron and manganese can also impart a rusty taste to the water when present. Tastes and odors are less noticeable when the water temperature is colder.

### COLOR

Organic compounds released into the water by decaying vegetation cause true color. These organic “dyes” are dissolved in the water and cannot be removed by filtration like turbidity. As leaves fall into the water, tannic acid is leached out giving the water a brownish color. Decaying aquatic plants or humus can create a green color in the water. Apparent color is caused by small particles of oxidized iron or manganese that create red or black water problems respectively. This type of “color” is actually small red flakes of rust that can be removed by filtration.

### SOLUBILITY OF SALTS

Most methods of chemical treatment rely on the solubility of different salts to remove undesirable minerals from the water. A salt is formed when a metal combines with a non-metal. For instance, when a metal like sodium combines with a non-metal like chlorine, sodium chloride, NaCl, or table salt is formed. The most common metals and non-metals that combine to form soluble salts in drinking water supplies are listed in Table 12.1.

Some salts dissolve very readily in water while others may not dissolve at all. Those that do not dissolve in water are known as insoluble salts. For instance, alum (aluminum sulphate) will dissolve in water but aluminum hydroxide,  $Al(OH)_3$ , is insoluble in water. Calcium bicarbonate,  $Ca(HCO_3)_2$ , is very soluble but calcium carbonate,  $CaCO_3$  will not dissolve once the pH reaches 9.0-9.5.

**Table 12.1 - Chemical Names & Symbols**

CHEMICAL NAMES AND SYMBOLS	
METALS	NON-METALS
Calcium – Ca	Carbonate – $CO_3$
Magnesium - Mg	Bicarbonate - $HCO_3$
Manganese – Mn	Hydroxide – OH
Iron – Fe	Sulphate - $SO_4$
Aluminum – Al	Chloride – Cl
Sodium – Na	
Copper - Cu	
CHEMICAL COMPOUNDS	
Calcium carbonate -	$CaCO_3$
Magnesium hydroxide -	$Mg(OH)_2$
Aluminum sulphate -	$Al_2(SO_4)_3$
Ferric (iron) chloride -	$FeCl_3$
Copper Sulphate -	$Cu SO_4$

Many of the undesirable minerals in water are present in the form of soluble salts. By adding certain other chemicals and adjusting the pH of the water, chemical reactions will take place that will change those soluble salts into insoluble salts. These insoluble salts can then be removed by either sedimentation or filtration.

### COMMON NAMES FOR WATER TREATMENT CHEMICALS

There are a number of water treatment chemicals that are better known by their common names than their chemical names. See Table 12.2.

**Table 12.2 - Water Treatment Chemicals**

Chemical Name	Chemical Symbol	Common Name
Aluminum Sulphate	$Al_2(SO_4)_3$	Alum
Calcium Hydroxide	$Ca(OH)_2$	Lime
Sodium Hydroxide	NaOH	Caustic Soda
Sodium Carbonate	$Na_2CO_3$	Soda Ash
Ferrous Sulphate	$FeSO_4$	Copperas

## pH

The pH of the water is the measurement of the acidity or alkalinity of the water. Water is considered to be acid when it has more hydrogen ions ( $H^+$ ) in it than hydroxide ions ( $OH^-$ ). Some of the chemicals that add hydrogen ions ( $H^+$ ) to the water are hydrochloric acid,  $HCl$ , sulfuric acid,  $H_2SO_4$ , nitric acid,  $HNO_3$ , and carbonic acid,  $H_2CO_3$ ,

Water is considered to be alkaline when there are more hydroxide ions ( $OH^-$ ) present than hydrogen ( $H^+$ ) Sodium hydroxide,  $NaOH$ , calcium hydroxide,  $Ca(OH)_2$ , and magnesium hydroxide,  $Mg(OH)_2$ , all add hydroxide ions ( $OH^-$ ) to the water. When the number of hydrogen ions and hydroxide ions are the same the water has a neutral pH. Pure water,  $H_2O$  or  $H-OH$ , has a neutral pH because the number of hydrogen ions ( $H^+$ ) and hydroxide ions ( $OH^-$ ) are equal.

The pH of water is measured on a scale that reads from 0 to 14. The midpoint of the scale is 7. Water with a pH of 7 is neutral. If the water has a pH less than 7, the water is acid and if the pH is greater than 7 it is alkaline. For every whole number that the pH changes the strength of the acid or alkaline properties of the water will change by a factor of ten times. Water that goes from a pH of 9 to a pH of 10 becomes 10 times more alkaline and water at pH of 5 is 10 times more acid than water at a pH of 6.

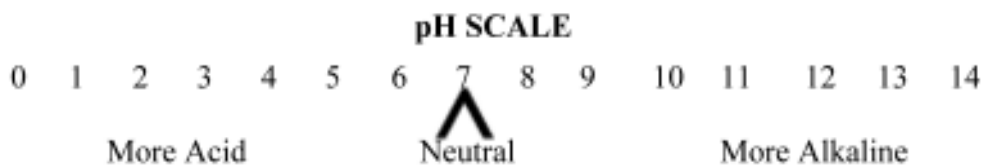

Figure 12.2 - pH Scale

## PHYSICAL/CHEMICAL TREATMENT

The purpose of chemical treatment is to remove any undesirable contaminants and produce water that is safe and acceptable to consumers. Removing undesirable impurities, using conventional treatment, requires the use of various treatment processes including: Pretreatment, Coagulation, Flocculation, Sedimentation, and Filtration.

**PRETREATMENT** refers to treatment of the raw water before it enters the treatment plant. It usually occurs at the raw water intake and involves some type of chemical addition with no physical treatment other than mixing. Chemicals used in pre-treatment include oxidizing agents for color or tastes and odors, activated carbon for tastes and odors, and aeration for iron or hydrogen sulfide gas.

**COAGULATION** is the chemical reaction that changes soluble salts into insoluble salts. This is accomplished by adding certain chemicals, known as coagulants, to the raw water. Coagulant aids are used to adjust pH and help in the formation of insoluble salts. These salts are referred to as floc. The formation of floc is accomplished by the even and thorough dispersal of the coagulant in the raw water by “rapid” or “flash” mixing. Changes in water quality or water temperature can have an adverse affect on the coagulation process.

**FLOCCULATION** is the process that follows the rapid mix. The velocity of the water is reduced and a gentle mixing action is created to allow the formation of insoluble salts, clay, and other suspended matter into floc particles. The negatively charged colloids are attracted to a positively charged coagulant and begin colliding to form a large neutral floc particle that will settle out during the sedimentation process. This process of bringing positive and negative charged particles together to form a floc that has a neutral charge, and is large enough to settle is called agglomeration.

A flocculation tank will usually incorporate baffles or mechanically driven paddles for mixing. It is important to keep the velocity of the water slow enough to prevent “hydraulic shear” This will prevent the floc particles from breaking up before they reach the sedimentation tank. One of the more common problems

occurring in flocculation basins is formation of pin floc. Underfeeding or overfeeding the coagulant chemicals usually causes pin floc. Pin floc can also be a problem when the raw water has a low turbidity or cold temperature. The addition of coagulant aids such as bentonite clay, activated silica, and polymers can improve the flocculation process.

**SEDIMENTATION** is the process of slowing the water velocity to allow the floc to settle out. Clear water is then drawn off the top of the basin for filtration. Sedimentation basins are usually the largest tanks in the treatment process. These basins should have baffles placed in them to prevent “short-circuiting.” Baffles are usually made out of wood or metal and used as an obstruction to the normal flow of water. Short-circuiting is a condition caused by allowing the influent to flow straight across the basin to the

effluent weir in less time than it would take if the flow were distributed evenly across the tank.

In circular basins the flow is directed down and in rectangular basins it is spread evenly across the influent end of the tank. As the water flows through the basin, the floc settles to the bottom forming a sludge blanket. Sludge is removed by means of a raking device that pushes the sludge to the center of circular basins or the end of rectangular basins where it is pumped out of the tank. Bulking occurs when sludge is not removed from the process often enough. This is a result of decomposition of organics in the sludge that causes gases to form and sludge to float to the surface. This decomposition can also create taste and odor problems.

**FILTRATION** is the final step in the removal of chemical impurities in water. Any organic or inorganic particles that have not been removed during the sedimentation process must be filtered out in order to meet the SDWA standards of 1.0 NTU or less in the finished water. The turbidity of the water in the filter influent should not exceed 15 NTU's, and should actually be less than 5 NTU's, or filter runs will be reduced dramatically. When the filter becomes dirty it must be backwashed. Since the backwash water is treated potable water, the length of the filter run directly impacts the cost of the filter operation. The backwash water must either be returned to the head of the plant or mixed with the raw water flow or impounded so that sludge can be separated.

### **REMOVAL OF COLOR**

The dissolved organic compounds that cause true color in water can be removed if the pH of the water is lowered to between 3.5 and 5.5. Under these acidic conditions the color compounds become gelatin-like solids that will settle out in the sedimentation tanks. This pH adjustment can be accomplished by adding alum or acids. Most of the other treatment processes will require a pH of 6.5 to as high as 11.5. If color is to be removed, the pH must be lowered first. If the pH is raised, the color may become set (much the same way that hot water will set laundry stains) and will be nearly impossible to remove. Older treatment plants are usually not equipped to handle this type of treatment, however, some up-flow units can be adapted to remove color because alum can be added to lower the pH prior to raising the pH for other types of treatment.

Color can also be removed by oxidation. Chlorine is sometimes used to oxidize color compounds and remove them. However, this can result in the formation of Trihalomethanes or THM's and is not usually recommended.

Other oxidizing agents such as ozone or potassium permanganate do a better job and do not create the THM byproducts associated with the use of chlorine.

### **REMOVAL OF BACTERIA**

Pathogenic bacteria tend to die out in surface water supplies. Sedimentation and filtration can also remove about 90% of these bacteria. However, those that are not removed during the treatment must still be destroyed with oxidizing agents. The possible presence of *Giardia* in surface waters is the main reason that filtration is now mandatory for all surface supplies. Higher chlorine residuals may also be necessary to meet the new C x T standards for *Giardia*. Using ozone as a disinfectant can reduce the difficulties created by the increased contact time needed to kill *Giardia*. Chlorination may still be required to meet secondary contamination considerations.

### **REMOVAL OF TASTE AND ODORS**

Taste and odors in water can come from several sources. Both organic and inorganic compounds can cause tastes and odors. The most common source of organic taste and odors is algae. These algae can be divided into two main groups that are responsible for most of these problems. They are classified, according to their color, into green algae and blue-green algae. Green algae are usually responsible for grassy or musty odor in water while the blue-green algae cause rotten fish type of odor.

Algae problems develop during hot, dry weather in the early summer. Algae blooms will begin in shallow coves as the water temperature rises. These blooms spread so rapidly that, in a week or two, enough algae is present to cause serious taste and odor problems. Some blue-green algae release poisonous by-products that can result in fish kills in severe cases. Algae blooms can also result in pH fluctuations in the impoundment as the CO<sub>2</sub> uptake increases during the daylight hours driving the pH higher. Diatoms are another group of algae that may be present in surface waters. They do not cause the offensive odors that the blue-green algae do, but their shells tend to plug filters.

Tastes and odors can also be caused by inorganic compounds and dissolved gases. Iron and manganese can cause rusty tastes. Hydrogen sulphide gas can cause a rotten egg odor.

### **COPPER SULPHATE TREATMENT**

Algae in lakes and reservoirs can be killed with copper sulfate, CuSO<sub>4</sub>. It usually requires dosages of about 0.5 to 1.0 mg/l to kill most algae blooms. However, if the action is taken early in the spring before these algal blooms occur, dosages as low as 0.1 mg/l may be sufficient. Copper sulphate is most effective when it is applied to soft waters that have a low hardness and a high pH. Never add copper

**Table 12.3 - Hardness Compounds**

<b>HARDNESS COMPOUNDS</b>			
<b>Carbonate</b>		<b>Non-Carbonate</b>	
Calcium carbonate	CaCO <sub>3</sub>	Calcium sulfate	CaSO <sub>4</sub>
Magnesium carbonate	MgCO <sub>3</sub>	Magnesium sulfate	MgSO <sub>4</sub>
Calcium bicarbonate	Ca(HCO <sub>3</sub> ) <sub>2</sub>	Calcium chloride	CaCl <sub>2</sub>
Magnesium bicarbonate	Mg(HCO <sub>3</sub> ) <sub>2</sub>	Magnesium chloride	MgCl <sub>2</sub>
Calcium hydroxide	Ca(OH) <sub>2</sub>		
Magnesium hydroxide	Mg(OH) <sub>2</sub>		

sulfate in dosages higher than 1.0 mg/l. Copper sulfate will kill many game fish at very low concentrations. Brown trout will not survive concentrations greater than 0.14 mg/l. Always contact state health officials before attempting this type of treatment.

### **IN-PLANT TREATMENT**

There are three methods of removing taste and odors at the treatment plant. Activated carbon can be used to adsorb the organic compounds that cause the problem. A dosage of 15 to 25 mg/l is usually required to accomplish this. In severe cases, dosages may need to be as high as 100 mg/l. Activated carbon should be added as far upstream as possible from the point where coagulant chemicals are added. If it is added at the same time as coagulant chemicals, it may become tied up in the floc particle before it has time to adsorb the organic taste and odor compounds. Activated carbon is very expensive and difficult to feed. It is also dangerous to handle because it can create an explosion if dispersed in the air and ignited.

The other method of taste and odor removal is by the addition of an oxidizing agent such as chlorine. The oxidizing agent will react with and chemically alter organic compounds so that they no longer cause taste and odors. The problem again is the creation of THM's as a byproduct of the chlorination process. The use of other oxidizing agents like chlorine dioxide or ozone should be considered instead of chlorine.

Tastes and odors caused by inorganic compounds like iron or hydrogen sulphide may be removed by aeration. Diffused air bubblers or stripping towers are the most common means of aeration. The dissolved oxygen will oxidize the iron and manganese and cause hydrogen sulfide to be forced out of the water. Removal of iron still requires some type of filtration to remove the oxidized rust particles that are formed. Use of aeration for treatment also has a drawback. In low pH waters dissolved oxygen can create serious corrosion problems

in the system. Oxidizing agents can also be used to remove inorganic tastes and odors.

### **REMOVAL OF MINERALS**

Mineral problems can be grouped into two major categories. These are problems related to hardness and problems related to other metals and gasses not associated with hardness such as iron, manganese, hydrogen sulfide, ammonia, and carbon dioxide.

### **HARDNESS**

Metals that are dissolved in water cause hardness. (See Table 12.3) Calcium (Ca) and Magnesium (Mg) are the two metals that dissolve the most easily in water. They are considered to be the main cause of hardness. Other metals also cause hardness in water but very few are soluble enough to contribute to hardness problems. The two metals that do not cause hardness in water are (Na) sodium and (K) potassium. Water with hardness of 0-60 mg/l is considered to be soft water. Moderately hard water is considered to be between 60-120 mg/l, while very hard water has hardness of 150 mg/l and up.

Hardness causing compounds are broken into two groups; carbonate hardness and non-carbonate hardness. Carbonate hardness is hardness that can be removed by boiling water. Non-carbonate hardness cannot be removed by boiling water. Carbonate and non-carbonate hardness are both a result of dissolved calcium and magnesium in water. It is the non-metals that combine with the calcium and magnesium that will determine whether it is carbonate or non-carbonate hardness.

Carbonate hardness is formed when calcium or magnesium combines with a form of alkalinity (carbonate, bicarbonates, or hydroxides.) Non-carbonate hardness is formed when calcium and magnesium combine with anything other than alkalinity. Chlorides and sulphates are the two most common forms of non-carbonate hardness.

## SOFTENING CHEMICAL REACTIONS

Carbonate hardness is removed by adding lime,  $\text{Ca(OH)}_2$ , to the water. The lime softening process requires the addition of enough lime to raise the pH to a point where the reaction can take place. The pH must be between 9.0 - 10.5 to remove carbonate hardness. Calcium compounds are removed at a pH of 9.0-9.5. Magnesium compounds require a pH of 10.0-10.5.

The reaction between lime and calcium bicarbonate results in the formation of calcium carbonate and water. At the proper pH calcium carbonate has a solubility of about 40 mg/l. The rest of the calcium will settle out as a floc.

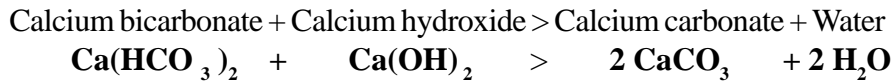

Magnesium hydroxide is the least soluble of the magnesium compounds. First magnesium bicarbonate reacts with lime to create magnesium carbonate and calcium carbonate. The calcium carbonate precipitates out and then the magnesium carbonate reacts with lime to create calcium carbonate and magnesium hydroxide that will both precipitate out.

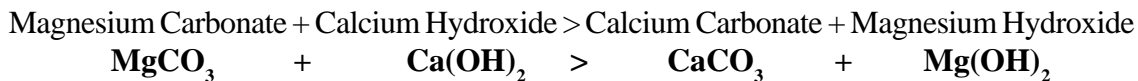
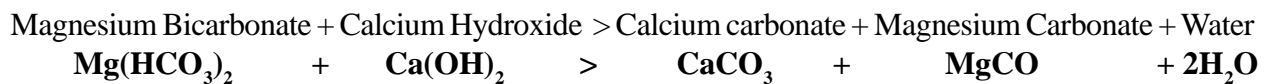

Non-carbonate or permanent hardness can be removed by the addition of sodium carbonate or soda ash,  $\text{Na}_2\text{CO}_3$ . Lime is usually added to adjust the pH of the raw water. This lime-soda ash process requires a pH of 10.0-10.5 to remove calcium compounds and a pH of 11.0 - 11.5 to remove magnesium compounds. When the proper pH conditions are met, the reaction between the sodium carbonate and the calcium sulphate results in the formation of sodium sulfate and calcium carbonate. The reaction is basically same for calcium chloride, except sodium chloride is created instead of sodium sulphate. The sodium does not cause hardness and the calcium carbonate that is insoluble will settle out. Magnesium compounds react directly with lime to precipitate as magnesium hydroxide. This results in the formation of calcium chloride or sulphate which must then react with soda ash to form calcium carbonate.

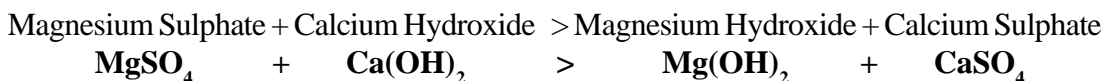
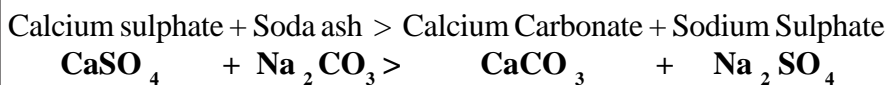

## RE-CARBONATION

After non-carbonate softening has taken place, the finished water will likely have pH of 10-11. This is a result of the lime addition that was needed to drive the softening reaction. If this water is pumped to distribution at this pH, the excess lime will cause calcium deposits in pipes and fixtures. Recarbonation is the process of stabilizing the water by lowering the pH and precipitating the excess lime as calcium carbonate. In large systems the amount of lime needed may make reclamation of the lime from the calcium carbonate sludge feasible. The sludge is heated in a furnace. The heat causes calcium carbonate to breakdown and calcium oxide, CaO, and carbon dioxide gas, CO<sub>2</sub>, are the result. The calcium oxide is "slaked" with water to form calcium hydroxide that is then reused in the softening process. The carbon dioxide gas is then used to react with the excess lime to lower the pH and precipitate more calcium carbonate. Recarbonation also requires additional coagulation, flocculation and sedimentation since it occurs after the initial softening process.

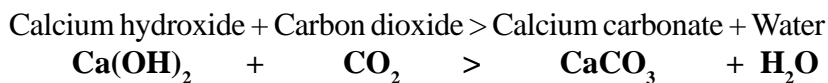

## OTHER SOFTENING PROCESSES

Systems that do not have the clarification equipment necessary for this type of treatment may soften water using the zeolite process. This is called an ion exchange process. Water is passed through a filter containing zeolite granules. A reaction takes place that removes calcium and exchanges it with sodium. The hardness can be lowered to 0 mg/l this way, since sodium does not cause hardness. The sodium that is put in the water may cause problems for people on the system who have high blood pressure or heart trouble, especially those on a salt-free diet. When the zeolite bed becomes saturated with calcium it must be regenerated, by backwashing it with a saturated brine solution.

Reverse-osmosis (R-0) may also be used in cases where chemical equipment is not available. R-0 is a process in which water, under pressure, is forced through a semi-permeable membrane (a distant cousin of the hot dog skin). The membrane will allow the water to pass through it but will trap the calcium, magnesium, and any other dissolved solids. The unit is periodically backwashed to clean the membrane. Electrodialysis may be used where water with very high concentrations of hardness (500+ mg/l) is found. Water is passed between two metal plates that are electrically charged. The reaction is similar to that used in a metal plating shop. All of the metals are attracted to the plate with the negative charge and the non-metals are attracted to the plate with the positive charge and are

removed from the water. Both R-0 and electrodialysis are very expensive from both an equipment and operation standpoint.

## IRON AND MANGANESE

Iron and manganese (Fe & Mn) can be found in reservoirs and lakes that are used for furnishing water to municipal systems. These minerals are also found in undesirable concentrations in waters from shallow wells or from wells drilled into shale or sandstone formations. The presence of large amounts of Fe and Mn can cause stains on plumbing fixtures, a rusty appearance and taste in the water (red water). Iron in excess of 0.3 mg/l will cause red water problems and manganese in excess of 0.05 mg/l will cause black water problems.

The least expensive means of controlling Fe and Mn in surface water supplies is to raise the raw water intake so that the water is taken from a point nearer the surface of the supply. This may reduce concentrations of Fe and Mn in the raw water because the concentrations of these minerals are normally higher at greater depths in the reservoir. The second alternative is to artificially supply dis-solved oxygen by means of aeration. This can be accomplished by installing a small aeration tower prior to the coagulation process. Aeration may also be achieved by forcing air into the water with blowers. Either method can provide the dissolved oxy-gen necessary to oxidize the Fe and Mn so it will settle out in the sedimentation tanks. Aeration requires longer contact time than other forms of oxidation. If it is used in a direct filtration process, a holding tank may have to be added after aeration to allow time for the reactions to take place. The remaining three alternatives require the addition of chemicals.

Pre-chlorination, or the addition of chlorine to the water before it reaches the sedimentation tanks, is an effective means of removal. In this case the chlorine acts as the oxidizing agent to precipitate the Fe and Mn. To achieve satisfactory percentages of removal enough chlorine must be added to provide a one part per million residual at the point of filtration.

Another oxidizing agent that can be added to remove Fe and Mn is potassium permanganate, KMnO<sub>4</sub>. It should also be added prior to coagulation. Enough potassium permanganate should be added to give the water a slight pink color as it goes to the filters. This method may also be used along with pre-chlorination. Never add KMnO<sub>4</sub> to water when the pH is less than 7.2 or manganese may actually be added to the water.



The final method of control is the addition of a sequestering agent. Polyphosphates, including sodium hexametaphosphate, also known as Calgon, are the most common sequestering agent used. This should be done as far in advance of the sedimentation process as possible if this is used by itself. If it is used in a conventional treatment plant, it should be added after sedimentation and before filtration. Polyphosphates should be used in small dosages, usually less than 5 mg/l. If excessive amounts are added it will begin to soften rust deposits in the distribution system and cause them to break loose. When this happens, serious plugging of hydrants or services can occur. It should be noted that polyphosphates do not remove Fe and Mn, but they do surround or sequester these ions and keep them in solution rather than allowing them to be oxidized and precipitate in the distribution system. Over time the polyphosphates will break down and release the Fe and Mn. They will then oxidize and create the red or black water. The proper dosage is just enough to keep the iron or manganese tied up for 4 days.

### DISSOLVED GASES

Carbon dioxide and hydrogen sulfide are the main causes of problems related to dissolved gases. Carbon dioxide will react with water to form carbonic acid and can create corrosive conditions in the water.

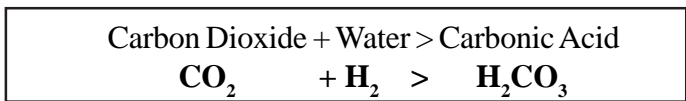

Carbon dioxide can be removed by aeration down to concentrations of 5 mg/l. Hydrogen sulphide can be completely removed by aeration. Lime may be added to further reduce the  $\text{CO}_2$  concentration. The lime will react with the  $\text{CO}_2$  and precipitate out as calcium carbonate.

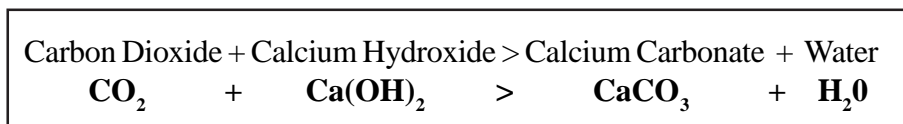

## OTHER MINERAL PROBLEMS

The inorganic primary contaminants listed in SDWA must also be removed if the MCL is exceeded. The addition of lime and alum or one of the iron-base coagulants such as ferric chloride or ferrous sulfate can remove most of these metals. A high pH is usually required to produce insoluble salts from these dissolved metals. Radioactive metals can also be removed in this manner. Ion exchange processes are also used to remove some non-metal contaminants. Activated alumina,  $\text{AlO}_3$ , can be used for arsenic and fluoride removal in a process that is similar to zeolite softening.

## CONTROL OF TURBIDITY AND COLOR

The control of turbidity, color, microorganisms and, to some extent, taste and odor is commonly accomplished through some type of filtration<sup>1</sup> system. The Surface Water Treatment Rule describes five different types of filtration systems; conventional treatment<sup>2</sup>, direct filtration<sup>3</sup>, slow sand filters, diatomaceous earth filters and alternate filtration systems such as cartridge filters. The basic system used in this discussion is the conventional treatment plant, also called rapid gravity filtration.

### CONVENTIONAL FILTRATION

The conventional treatment plant is composed of four processes (see Figure 12.3 - *Conventional Treatment Plant Schematic*):

- *Coagulation*<sup>4</sup> - a process where chemicals are added in order to destabilize small particles held in suspension
- *Flocculation*<sup>5</sup> - a slow mixing process where the coagulated particles are formed into feather-like material called floc<sup>6</sup>
  - *Sedimentation* - is a physical process that allows the majority of the floc to settle, removing a large portion of the material in the water
- *Filtration* - the process of straining the remaining floc from the water.

---

<sup>1</sup> **Filtration** - The process of passing liquid through a filtering medium (which may consist of granular material such as sand, magnetite, or diatomaceous earth, finely woven cloth, unglazed porcelain, or specially prepared paper) to remove suspended colloidal matter.

<sup>2</sup> **Conventional Treatment** - A standard treatment process involving coagulation, flocculation, sedimentation, filtration, and disinfection.

<sup>3</sup> **Direct Filtration** - A gravity or pressure filter system involving coagulation, filtration, and disinfection.

<sup>4</sup> **Coagulation** - In water treatment, the destabilization and initial aggregation of colloidal and finely divided suspended matter by the addition of a floc-forming chemical.

<sup>5</sup> **Flocculation** - The agglomeration of colloidal and finely divided suspended matter after coagulation by gentle stirring by either mechanical or hydraulic means.

<sup>6</sup> **Floc** - Small gelatinous masses formed in a liquid by the reaction of a coagulant added thereto.

These processes are used to remove or reduce organic and inorganic material that cause turbidity, color and odor and taste.

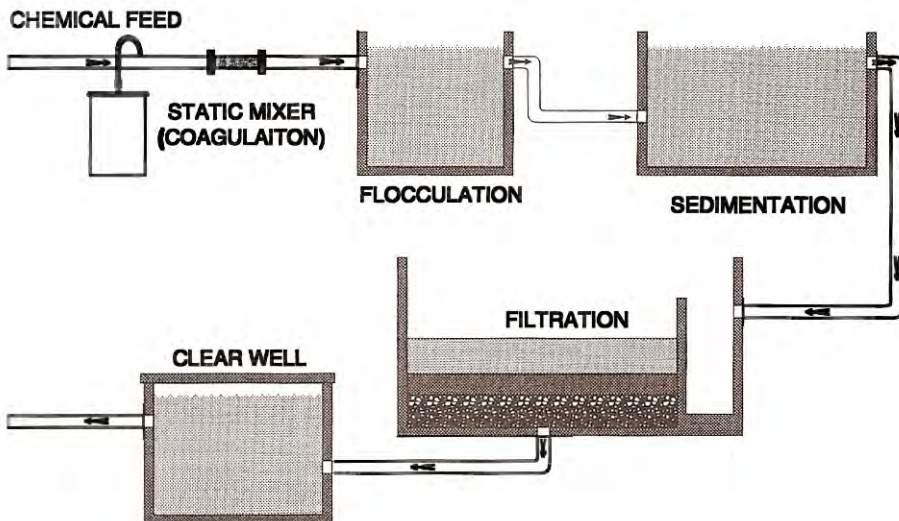

Figure 12.3 - Conventional Water Treatment Plant Diagram

**CONTAMINANTS**

Organic Contaminants

The organic component of this material contributes to color, odor, taste and disease. The organic component includes microorganisms, (viruses, bacteria, protozoa), algae, and organic material from plants and animals.

Inorganic Contaminants

The inorganic portion of this material is the primary contributor to turbidity. The inorganic portion includes silt, sand and inorganic chemical complexes.

**SETTLING**

Table 12.4 - Settling Rates

Particle Diameter mm	Representative Particle	Time Required to Settle in 1 ft. (0.3 m) Depth
<i>Settleable</i>		
10	Gravel	.03 sec
1	Coarse Sand	3 sec
0.1	Fine Sand	38 sec
0.01	Silt	33 min
<i>Considered Non-Settleable</i>		
0.001 (1 μ)	Bacteria	55 hours
0.0001	Color	230 days
0.00001	Colloidal Particles	6.3 years
0.000001	Colloidal Particles	63 years minimum

Most organic and inorganic material is suspended in the water and not dissolved and therefore will settle out if given enough time. However, the main materials that contribute to color and turbidity are too small to settle. The basic problem comes from material that is less than one micron in size, called *colloidal*<sup>7</sup> material. The Greek letter “μ”, called “mu” is used to identify a micron. One micron would be written 1μ.

Colloids

For instance, a particle 0.01 mm in diameter will settle 1 foot in 33 minutes but a particle 0.0001 mm in diameter (a colloid) will only settle 1 foot in 230 days. This is hardly a reasonable settling time.

Colloids do not settle in a reasonable length of time due to electrical charges on their surface. At one micron in size the influence of the surface charges offsets the attraction due to gravity and the particles stay suspended.

**TYPES OF COLLOIDAL MATERIAL**

There are two types of colloidal material *hydrophobic*<sup>8</sup> and *hydrophilic*<sup>9</sup>.

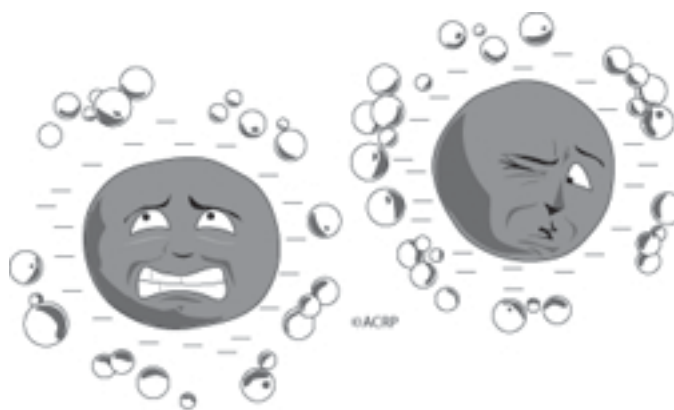

Figure 12.4 - Hydrophobic Particles

Hydrophobic

Hydrophobic means water-fearing. Hydrophobic colloidal material is mostly inorganic material that contributes to

<sup>7</sup> **Colloidal** - Any substance in a certain state of fine division in which the particles range in diameter from about 1.0 to 0.005 micron

<sup>8</sup> **Hydrophobic** - Water fearing. In water, hydrophobic refers to inorganic colloidal particles that contribute to turbidity.

<sup>9</sup> **Hydrophilic** - Wte loving. In water, hydrophilic refers to organic colloidal particles that contribute to color..

turbidity. Hydrophobic colloidal material generally carries a negative electrical charge.

### Hydrophilic

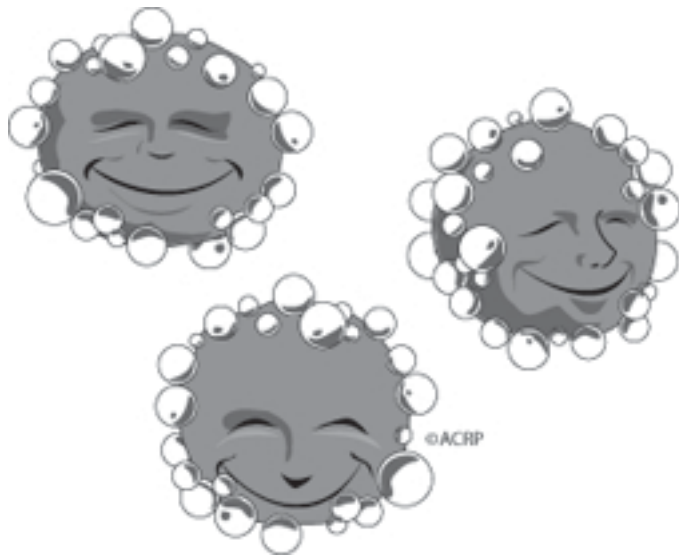

**Figure 12.5 - Hydrophilic Particles**

Hydrophilic means water-loving. Hydrophilic colloidal material is mostly composed of organic material which is the common source of color. Hydrophilic compounds are surrounded by water molecules and because of their polarization, they tend to make these particles negatively charged.

### Opposing Forces

There are two opposing forces that impact the removal of colloidal material. These are stability factors and instability factors. Stability factors are those factors that help to keep colloids dispersed. Instability factors are those that contribute to the natural removal of colloids.

## **COAGULATION - THEORY**

### **THE CHEMICALS**

The process of decreasing the stability of the colloids in water is called coagulation. Coagulation results from adding salts of iron or aluminum to the water. Common salts are:

- Alum<sup>10</sup> - Aluminum Sulfate  $Al_2(SO_4)_3 \cdot 18H_2O$
- Sodium Aluminate -  $NaAlO_2$
- Ferric Sulfate -  $Fe_2(SO_4)_3 \cdot 9H_2O$
- Ferrous Sulfate -  $FeSO_4 \cdot 7H_2O$
- Ferric Chloride -  $FeCl_3$
- Polymers

### Coagulation

The reaction between one of these salts and water is called coagulation. The simplest coagulation process to explain occurs between alum and water. When alum is placed in water, a chemical reaction occurs that produces positive charged aluminum ions.

### The Reaction

The overall result is the reduction of electrical charges and the formation of a sticky substance. These two destabilizing factors are the major contributions that coagulation makes to the removal of turbidity, color and microorganisms.

### Factors that Influence Coagulation

There are a number of factors that influence the coagulation process. Five of the most important are: pH, turbidity, temperature, alkalinity and the use of *polymers*<sup>11</sup>. The degree to which these factors influence coagulation is dependent upon the coagulant used. The following discussion is based on the use of alum as the coagulant.

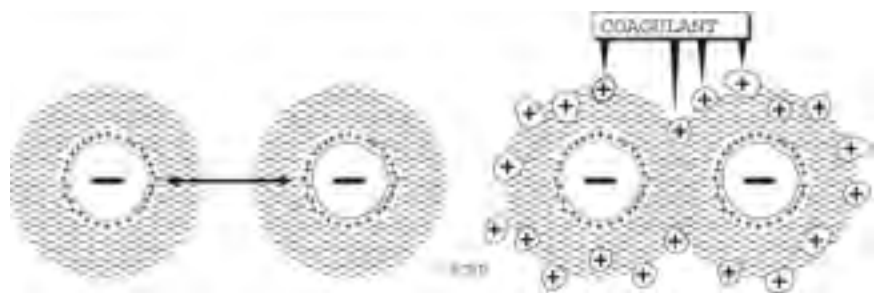

**Figure 12.6 - Alum in Water**

### Other Considerations

The raw water conditions, optimum pH for coagulation and other factors must be considered before deciding which chemical is to be fed and at what levels.

<sup>10</sup> **Alum** - Trade name for a common coagulant aluminum sulfate,  $Al_2(SO_4)_3 \cdot 18H_2O$

<sup>11</sup> **Polymer** - High-molecular-weight synthetic organic compound that forms ions when dissolved in water. Also called polyelectrolytes.

## POLYELECTROLYTES OR POLYMERS

Polyelectrolytes, or polymers as they are commonly called, can be used as an aid to coagulation. In some waters they have been successfully used as the primary coagulant instead of alum or one of the iron salts. The practice of using a polymer as a primary coagulant is not always successful.

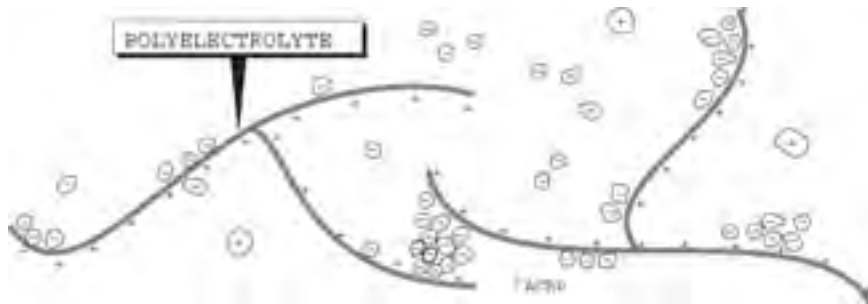

Figure 12.7 - *Polyelectrolyte*

### What are Polymers

Polymers are long string-like chain molecules with charges placed along the string. There are three common types of polymers; positive charged polymers called cationic polymers, negative charged polymers called anionic polymers, and polymers with no charge called nonionic polymers. The correct type is selected depending on the use of the polymer; as a filter aid, a coagulation aid or as a primary coagulant.

### Determining Chemical Dosage

In order to determine the correct chemical dosage a device called a gang stirrer or jar tester is used. The most common of these is composed of six stirrers connected together and six one-liter beakers. A sample of the water, along with various dosages of the coagulation chemicals, is added into the jars. The jars are stirred in an attempt to duplicate the flash mix of the plant and then slowly stirred to duplicate the flocculation portion of the plant. The proper dosage is determined by observing the best forming floc, the pH and the turbidity of a filtered sample of the water.

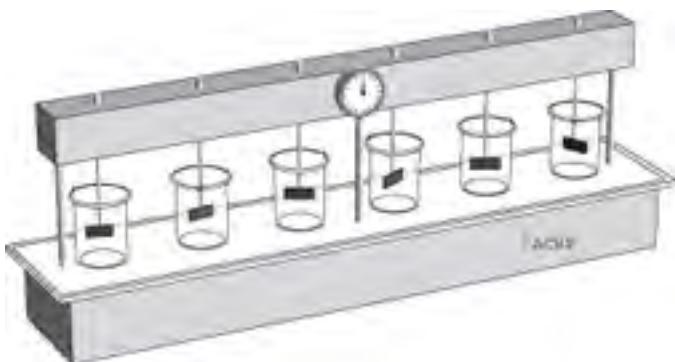

Figure 12.8 - *Jar Test Apparatus*

## CHEMICAL FEEDERS

Chemical feeders are necessary to assure that the proper amount of each chemical is added to the water on a continuous basis. Each feeder must have a storage bin, a device that feeds the chemical into a solution tank where it is dissolved, and a delivery system to add the chemical at the proper point in the treatment process. Chemical feeders are either volumetric or gravimetric. Volumetric feeders are the most common. They include auger feeders and positive displacement metering pumps.

The actual proportional feeding device may be a screw auger, a rotating disc, an oscillating shelf, or a variable speed conveyor belt. The feeder control may be calibrated in pounds per day but usually the scale simply reads from 1 to 10 or 1 to 100.

The manufacturer may provide a chart that can be used to determine what the feed rate is a given setting. If not, the operator can calibrate the machine manually. This should be done periodically to determine if the machine is in need of cleaning or maintenance due to clogging or belt slippage. The first step is collecting and weighing the amount of chemical fed in one minute at several different settings. These figures multiplied by 1,440 minutes per day will give pounds per day feed rate. These points can be plotted to create a straight-line graph that can be used to accurately set the feed rate.

Each chemical used in water treatment has specific safety considerations regarding its handling and storage. Operators should be aware of the potential hazards always use appropriate personal safety equipment when handling these chemicals or working around feed equipment. Respiratory protection is always appropriate when handling any dry chemicals. Activated carbon dust can be explosive and wet activated carbon can deplete the atmosphere of oxygen. Alum and polymers become very slippery when wet. The ferric and ferrous salts are very corrosive. Oxidizing agents are also very corrosive. Chlorine gas is also toxic and any chlorine product, including HTH and bleach, will react violently with organic compounds and react with acids to release chlorine gas. Always dilute acids and bases very carefully. These chemicals should always be added to the water when diluting them because of the heat that is generated by the reactions that take place. Always check the Material Safety Data Sheet (MSDS) if there are any questions regarding handling or use of any chemicals. These may be obtained directly from the chemical supplier or manufacturer.

## PRETREATMENT EQUIPMENT

Pretreatment equipment usually refers to chemical feeders and in-line mixers that are used prior to coagulation when oxidizing agents or activated carbon are being used for taste and odor removal. Air stripping towers or other aeration equipment would also be included in this category. Other reasons for pre-treatment might include disinfection as pretreatment to maximize contact time for *Giardia* removal or pH adjustment for color removal. Mixing can be accomplished using mechanical mixers, static in-line mixers, or simply injection at the suction side of the raw water pump, using the pump as a mixer. Pretreatment should occur as far upstream from the treatment as possible in order to maximize the contact time prior to coagulation.

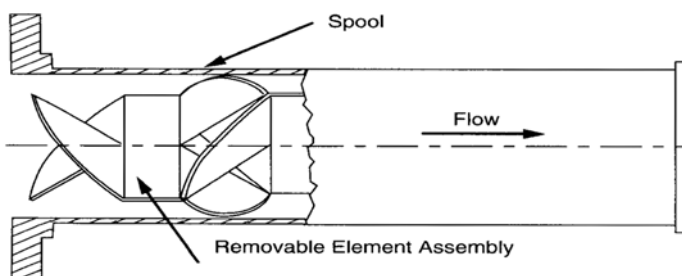

Figure 12.9 - Static In-Line Mixer

## COAGULATION EQUIPMENT

The coagulation process, or rapid/flash mix, is most often accomplished using mechanical mixers in a tank that has a

detention time of 1-3 minutes. Mixing velocities should be between 5-7 ft/sec. The tank may be dual-chambered. This design allows the coagulant aids to be added first. The raw water should have the proper pH and alkalinity, and have other aids like polymers or bentonite clay present before the flow enters the mixer chamber. In-line mixers may also be used for coagulation and flash mixing. In either case, it is important to add the coagulant aid far enough upstream that the pH adjustment occurs before the coagulant is added. The raw water should be tested for pH, alkalinity, turbidity, temperature, tastes and odors, and color. If softening is an issue, hardness tests should also be run. pH should also be checked after coagulation.

Jar tests should run on the raw water to determine the optimum coagulant dosage. The amount of coagulant needed for good floc formation can be affected by changes in the raw water quality. Raw water should be checked for turbidity, pH, alkalinity, temperature, color, and tastes and odors. Floc does not form as well or as fast in colder temperatures requiring higher coagulant doses. Changes in pH will change the amount of coagulant aid needed. Changes in turbidity will have an effect on the amount of coagulant required. Higher turbidities do not necessarily mean more coagulant will be used. Because there are more particles available in highly turbid water, it may actually require less coagulant to form a good floc particle. In fact, waters with very low turbidities may require the addition of a coagulant aid, like bentonite clay or activated silica that increases the turbidity in order to produce a better floc particle.

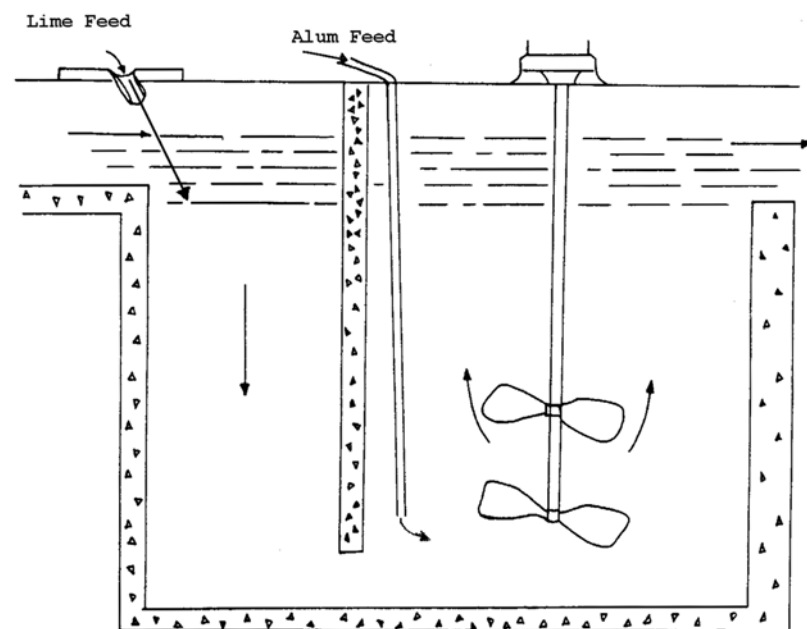
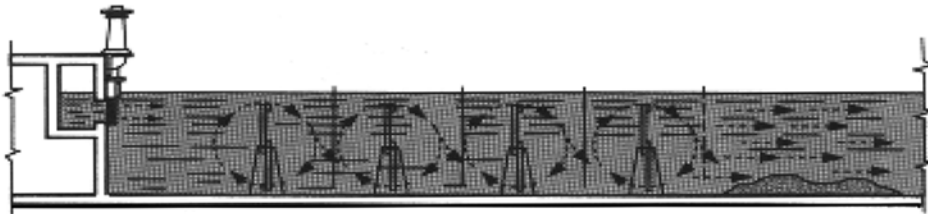

Figure 12.10 - Dual Compartment Rapid Mix

## FLOCCULATION EQUIPMENT

The flocculation process takes place in a much larger basin. The average detention time is 30-60 minutes. Changes in temperature can necessitate longer detention times because floc formation takes longer in colder water. The velocities in the flocculation basin should be about 1 ft/sec. This velocity will provide the maximum particle collision rate without causing hydraulic shear. If the velocity drops below 1 ft/sec, settling may occur in the corners of the basin. The proper velocity is maintained by means of mechanical mixers. It is important to have the ability to adjust the mixer speed to compensate for changes in flow and temperature that can impact floc formation. The flocculation effluent should be checked visually prior to sedimentation. (See Figure 12.11 - Types of Flocculators.)



**Propeller Flocculator**

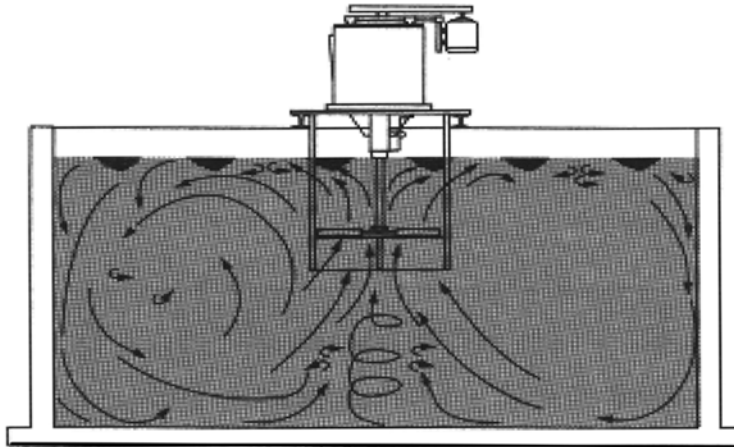

**Turbine Flocculator**

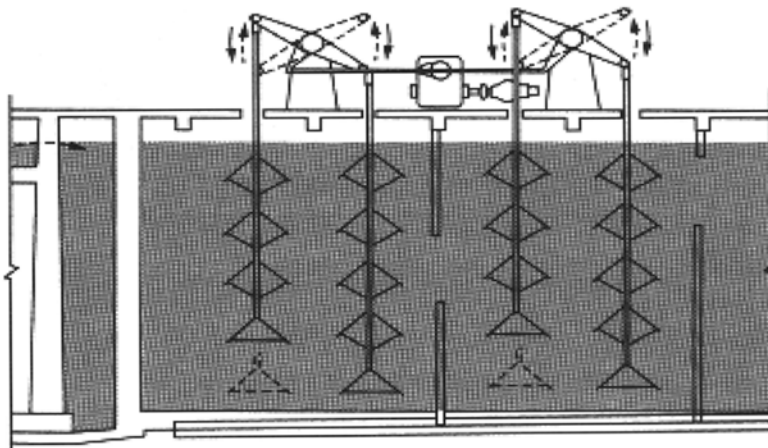

**Walking-Beam Flocculator**

**Figure 12.11 - Types of Flocculators**

**SEDIMENTATION EQUIPMENT**

Conventional treatment plants will use either rectangular or circular sedimentation basins. Every sedimentation basin can be divided into four zones:

**INFLUENT ZONE**

The Influent Zone is the inlet to the sedimentation basin. Water enters the end of a rectangular tank and the center of a circular or square tank. The influent zone will be equipped with a baffle. Circular tanks will have a collar-type circular baffle that directs the water down as it enters the center of the tank. Rectangular tanks will have a perforated wall that spreads the water laterally across the inlet end of the tank. The purpose of the baffle is to prevent short-circuiting. Short-circuiting reduces the detention time in the tank causing floc to carry over onto the filters and causes uneven distribution sludge

**SETTLING ZONE**

The **Settling Zone** represents the largest portion of the tank. The water velocity is reduced to 0.01-0.03 ft/sec and the detention time is 4-6 hours. Slowing the water down for this long allows the sludge to settle to the bottom while the water is removed from the top of the tank. Sedimentation tanks are usually only about 8-12 feet deep and have a surface loading rate of about 800 gpd/sq.ft. This keeps the upward velocity of the water low enough to minimize floc carryover. A tank that is 20' x 50' (1000 sq.ft.) and designed with a surface loading rate of 800 gpd/sq.ft. would have a maximum design flow of 800,000 gallons/day. Tube settlers are sometimes used in sedimentation basins to improve settling rates.

**EFFLUENT ZONE**

The **Effluent Zone** is the part of the tank where the settled water leaves to go to the filters. In rectangular tanks the water leaves at the end opposite the influent. In circular or square tanks the water leaves at the edge of the tank. A channel called the effluent launder collects the effluent flow and directs it to the effluent piping. Weirs are installed along the edge of the effluent launder channel to skim the water evenly off the surface of the tank. The most common type

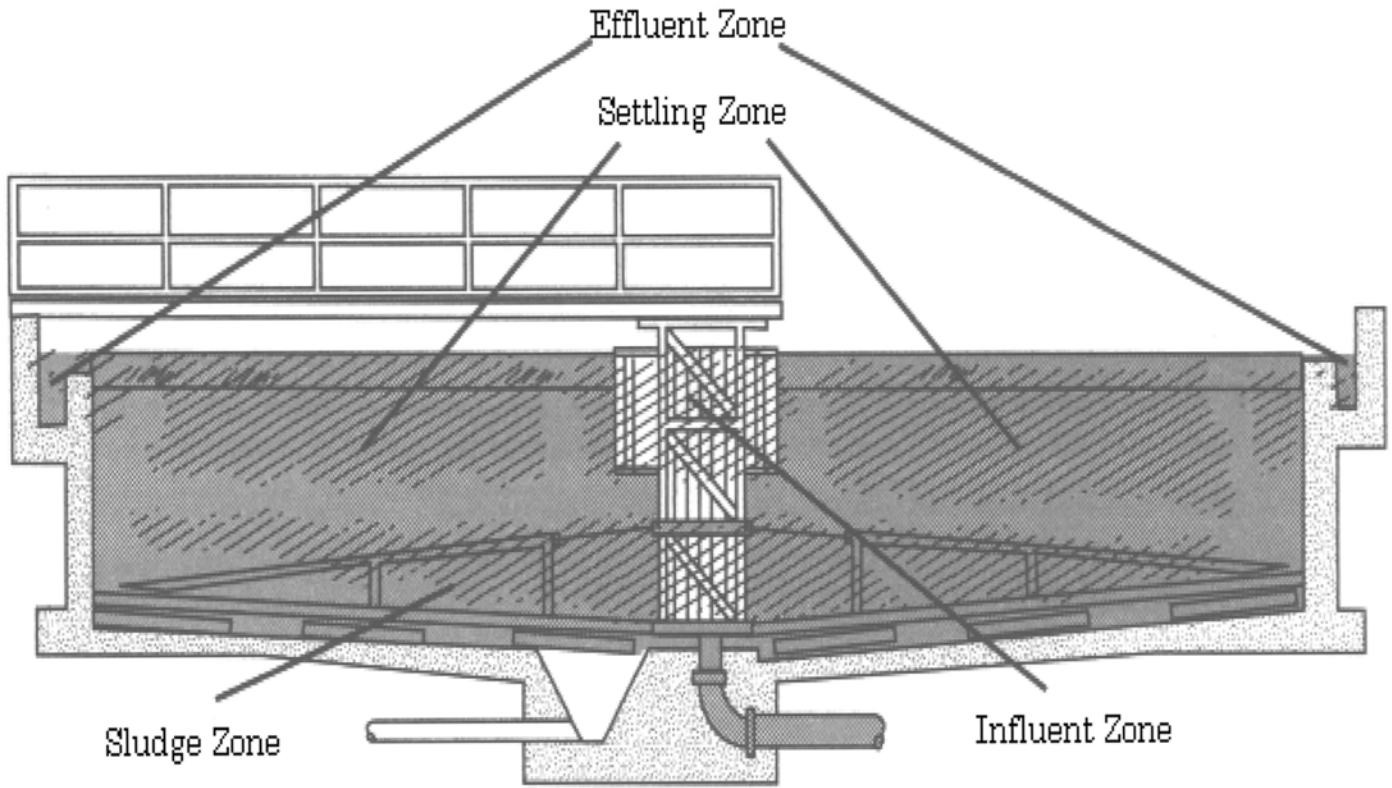

**Figure 12.12 - Four Zones of a Sedimentation Basin**

of weir is a V-notch weir. A V-notch weir is a plate that has V-notches, that are about 2-3 inches deep, cut in it every 8-12 inches. If the weir is clean and level, it will remove water evenly all the way around the edge of the tank. This

6-8 inches inside the weir, may also be installed to prevent floating solids from going over the weir. The design criterion for weirs is the weir overflow rate. The weir overflow rate determines how many gallons can pass over each foot of weir each day. The standard weir overflow rate is between 10,000-14,000 gpd/ft. Our basin with a design flow of 800,000 gpd would require about 57 feet of weir to maintain a 14,000 gpd/ft weir overflow rate ( $800,000 \text{ gpd} / 14,000 \text{ gpd/ft} = 57.15 \text{ ft}$ ).

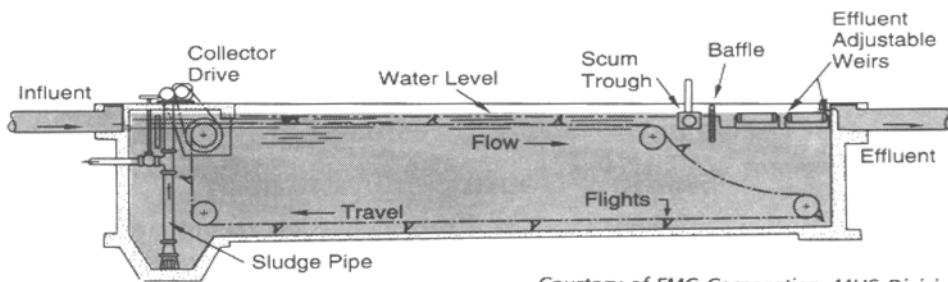

Courtesy of FMC Corporation, MHS Division

**Figure 12.13 - Rectangular Sedimentation Basin**

**SLUDGE ZONE**

The **Sludge Zone** is the bottom of the tank where the settled sludge collects. Sludge blanket

minimizes the upward velocities near the effluent launder to reduce floc carryover. If the weir plate is not level or part of the weir becomes clogged with algae or chemical scale, short-circuiting will result because more water will pass over the low, clean side of the weir. The result will be poor settling and uneven sludge blanket buildup. A baffle plate, in the form of a ring

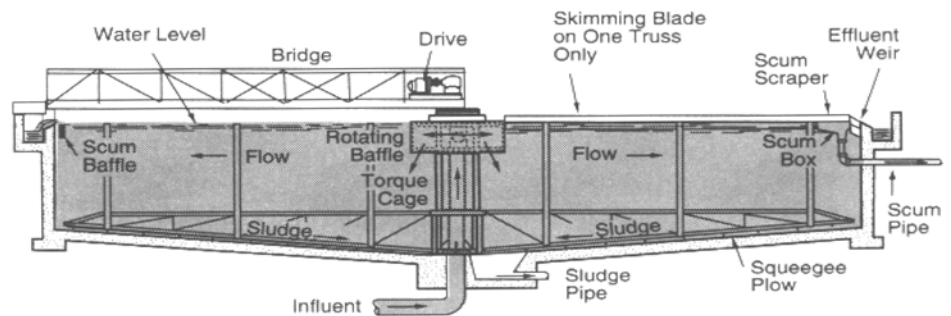

**Figure 12.14 - Circular Sedimentation Basin**

depth should be measured periodically and sludge should be removed every shift or at least once a day. Sludge rakes push the sludge to one end or the center of the tank so that it can be pumped out. The rake drive is usually equipped with a torque indicator. The torque indicator resembles the indicator on a torque wrench. A needle moves across a graduated scale that indicates how much force is needed to move the rake through the sludge. If too much torque is applied, a shear pin in the drive shaft will break to prevent damage to the gearbox or drive shaft. A fluctuating torque reading indicates uneven sludge buildup in the sludge zone. Short-circuiting in the tank usually causes this. Failure to remove sludge often enough will result in bulking. The sludge can become septic and float to the top where it can be difficult to remove. It can also result in taste and odor problems.

## UP-FLOW CLARIFIERS

Many new plants use up-flow or solids-contact type clarification equipment instead of conventional equipment. Up-flow clarifiers combine coagulation, flocculation, and sedimentation all in one unit. This can save money because less space is needed and the cost of the construction is less. One type of up-flow unit utilizes a sludge blanket that the water must pass through as it leaves the tank. The influent enters the center of the tank where chemicals are added and mixed by an impeller. The water flows downward

and out under the hood that is in the center of the tank as the hood widens at the bottom, the velocities are reduced and flocculation begins. The floc is just starting to form as water passes up through the sludge blanket. The sludge blanket filters out the floc particles as the clarified water leaves the unit. Since the floc does not have to get big enough to settle, and the sludge blanket filters it, true settling is not required. The detention times in these units can be as little as 2 hours. This means that a much smaller tank can be used and because there is no need for separate coagulation and flocculation basins installation costs for these types of processes is much lower than conventional treatment.

Process control is accomplished by adjusting the turbine or mixer speed and regulating the sludge blanket density. The mixer supplies the energy for mixing, flocculation and sludge blanket suspension. Adjustments that are made to compensate for flow or temperature changes must be very gradual. The adjustment should not exceed 2-3% at a time. The sludge blanket is monitored by drawing sludge samples and spinning them in a centrifuge. Chemical sludges should be maintained between 12-18% by volume in the centrifuged sample. Once an optimum range has been determined, sludge removal should occur as often as needed to maintain that particular density.

## FILTRATION EQUIPMENT

Filtration is can be accomplished using either pressure or gravity filters. Gravity filters are more common in swimming pools and small systems while large systems will probably have one of the three types of gravity filtration. Gravity filters can be slow sand filters, rapid sand filters, or high rate filters. Filtration normally follows sedimentation in surface water treatment. Direct filtration refers to filtration without sedimentation, and is only effective when raw waters have very low turbidity.

### PRESSURE FILTERS

Pressure filters operate under the same principles as gravity filters except the influent is forced through the filter under pressure. Pressure filters are steel cylinders that use sand or other media to remove particulates. They must be backwashed when the media gets

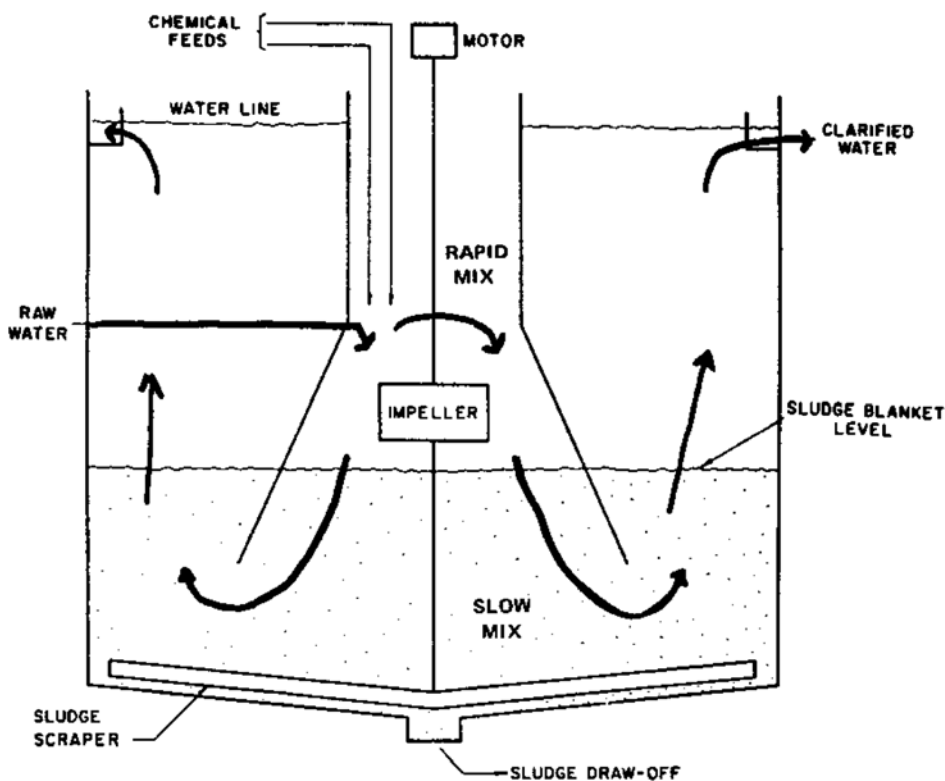

Figure 12.15 - Up-Flow Clarifier



clogged with solids. This is usually accomplished by manually operating the filter valves to reverse the flow through the filter bed. Pressure filters have about the same filter rate as gravity filters with the same type of media. Diatomaceous earth is another type of media that may be used instead of sand in some pressure filters.

material collects on the surface of the filter bed and forms a layer known as a smutzdecke. When the filter gets clogged it is taken out of service and cleaned by scraping the top inch of sand off of the filter bed. This material must be replaced after several cleanings to restore the original media depth. After a filter is cleaned, it must be filtered to waste for several days before it can be put back in service. Because of this, a system must have two filters to provide continuous service. The filtration rate of a typical slow sand filter is about 0.05-0.15 gpm/sq.ft.

**RAPID SAND FILTERS**

Conventional rapid sand and mixed media filters have many design similarities. The basic components of the filters include all of the components described below. The main differences will be in the type of media that is used and the valving configurations.

Filter boxes may be constructed as rectangles, squares, round, or as the outer segment of a ring. A filter box is approximately ten feet deep, though its surface di-mensions may vary depending on the volume of water to be filtered.

The underdrain serves three basic functions. (See Figure 12.18 - *Filter Underdrain System*.) Although it supports the filter media and collects the filtered water, its most important function is to evenly distribute the backwash water throughout the filter. Leopold tile and Wheeler blocks (see Figure 12.19 - *Wheeler Filter Block*) are two popular types of underdrain systems

Filter media consists of sand, gravel, and small rocks of varying sizes. Six to eight inches of small rock is placed on top of the filter underdrain. A layer of pea gravel is placed on top of the rocks, usually three to six inches in depth, followed by layer of gravel of increasingly smaller size. This material will support the sand and keep it away from the underdrain. The actual filter media is a layer of medium size sand about 24 inches in depth. This sand should be sized so that the grains are between 0.3 to 0.6 millimeters in diameter. The uniformity coefficient for the sand media should be at least 0.9. This means that 90% of the grains will fall within the 0.3-0.6 mm range.

The rate of flow controller maintains a constant flow of water throughout the filter run. As the filter media becomes clogged the rate of

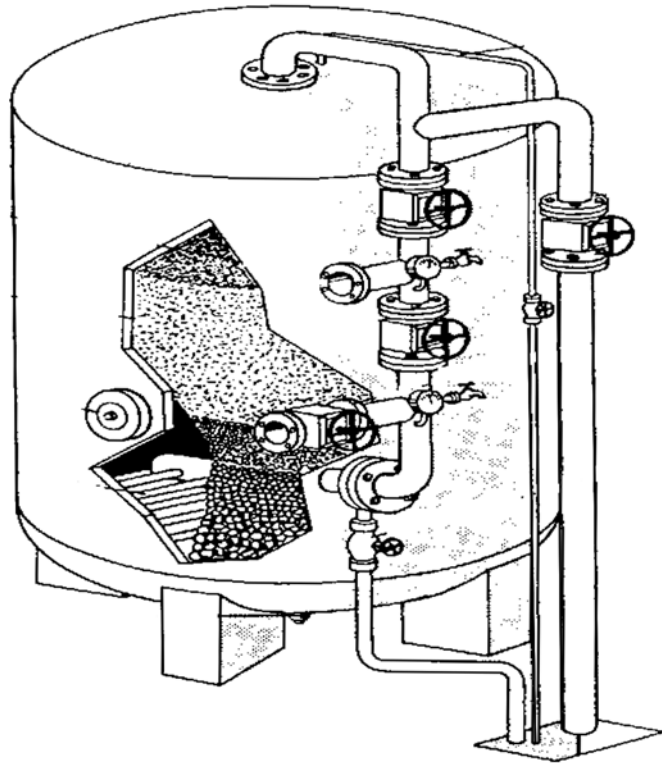

**Figure 12.16 - Pressure Filter**

**SLOW SAND FILTERS**

Slow sand filters were the first type of gravity filter used for water treatment. They consist of a box and underdrain that is filled with about 3.5 ft. of filter sand. Suspended

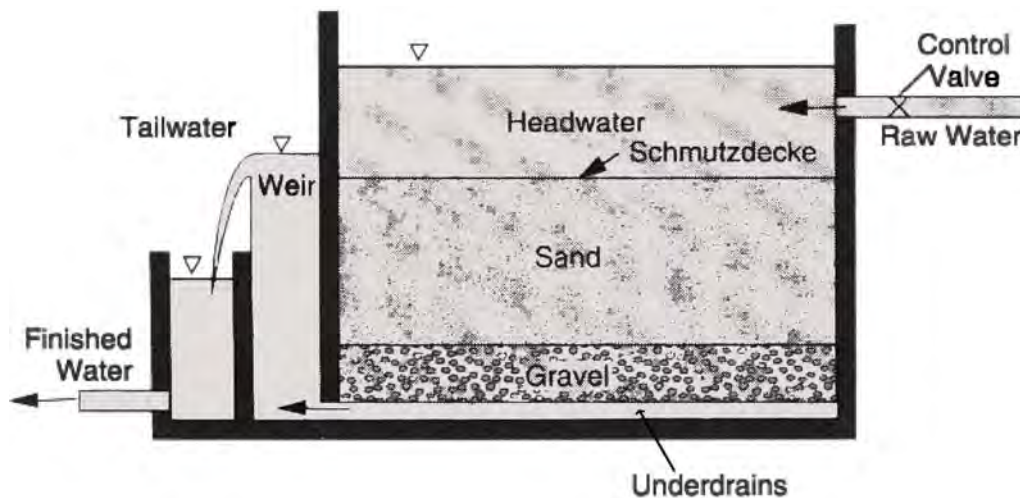

**Figure 12.17 - Slow Sand Filter**

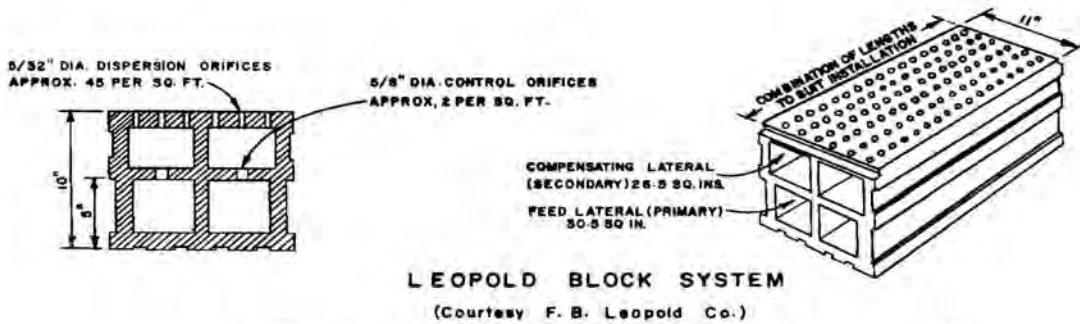
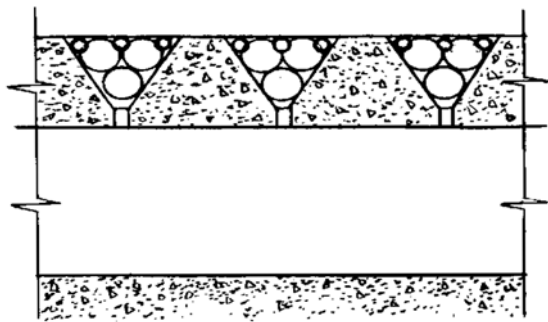
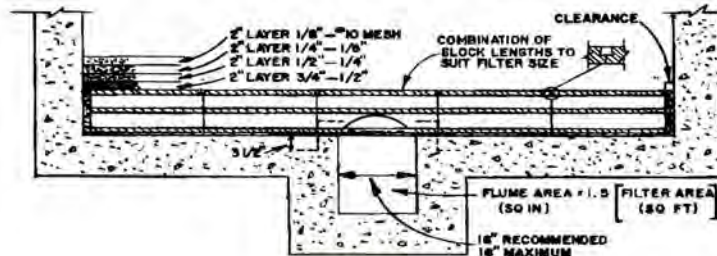

Figure 12.18 - Filter Underdrain System



(Courtesy of B I F)

Figure 12.19 - Wheeler Filter Block

The “backwash valve” provides a means for cleaning the filter and the “waste valve” allows the backwash water to leave the filter. A “filter-to-waste valve” is used to waste the first few minutes of the filter run allow the filter media time to compact. This is important to prevent turbidity or *Giardia* from passing through the filter before the media is compacted. A sixth, the “surface wash valve”, is also used when surface washers are installed. Surface washers of some type will usually be found on all new filter installations.

flow controller opens a valve on the effluent line that compensates for the head loss through the filter. When the head loss reaches 8 feet, the rate of flow controller is fully open.

Loss of head gauge indicates when the filter is in need of backwashing. The loss of head is determined by the difference between the level of water in the filter and the level of a column of water that represents the pressure in the effluent line. This is referred to as the feet of head loss through the sand bed. When the head loss reaches 8 feet the filter should be backwashed.

Five valves are needed to properly operate a filter. The “influent” and “effluent” valves are open during normal operation and closed during backwash.

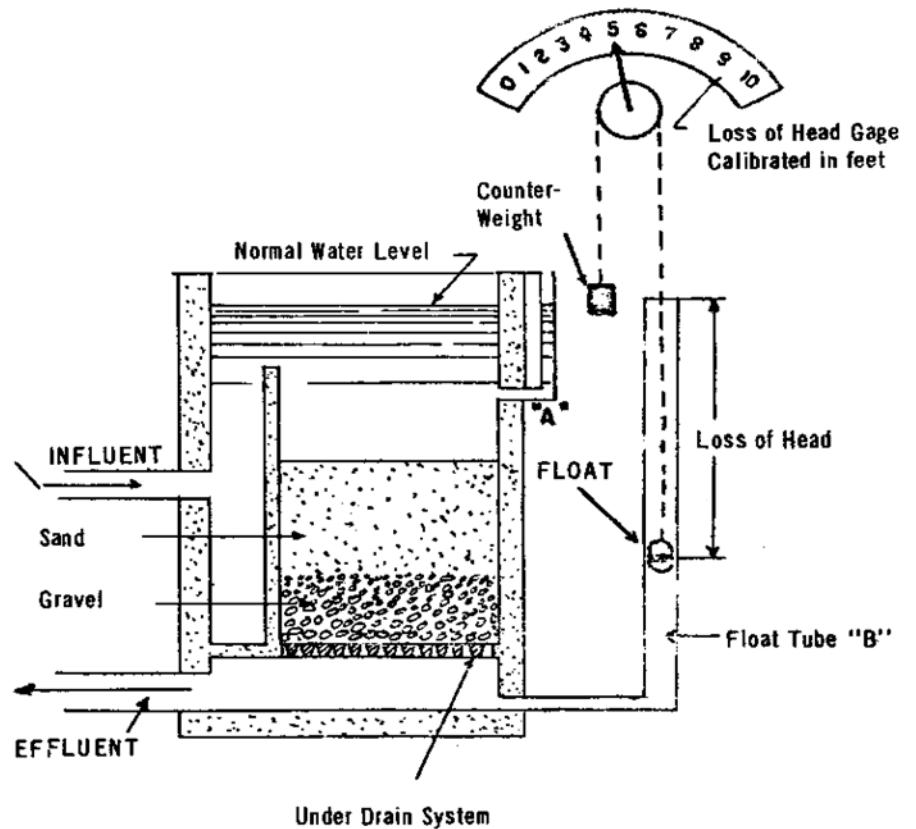

Under Drain System  
Figure 12.20 - Loss of Head Gauge

Backwash troughs collect the backwash water and transport it out of the filter. These troughs should be no farther than six feet apart and the rim of the trough should be 24-28 inches above the filter media. This is known as the freeboard of the filter. In filters that use anthracite coal in the media, the freeboard should be 32-36 inches to prevent loss of media during backwash.

Surface washers are used during the backwash cycle to agitate and break up the top layer of the sand where most of the dirt is trapped. This step helps reduce the amount of backwash water needed for a filter by reducing the time it takes to properly clean the filter.

A backwash pump or tower is used to supply the backwash water to the filter. It must be capable of supplying at least 15 gpm/sq. ft. of filter area. Enough backwash water must be available to run the backwash for 7-15 minutes on average.

excessively high head loss may cause the filter to become air bound. Air bound filters will have a high head loss immediately after backwash. This happens because the part of filter that is air bound is not filtering water and the clean part of the bed is filtering at a rate higher than 2 gpm/sq.ft. as a result. Filter runs should not exceed 100 hours without backwashing even if the head loss is less than 8 feet. After 100 hours the media may begin to pull away from the side of the filter and allow water to pass through without being filtered. This results in filter breakthrough and will result in high effluent turbidity. This is the primary cause of sudden increases in effluent turbidity readings. Short filter runs can result from poor chemical treatment and sedimentation. Jar tests should be run to improve the upstream processes to correct this problem.

### BACKWASHING FILTERS

When a filter has been in operation for its optimum number of hours or its head loss reaches 8 feet the filter is taken

out of service and backwashed. The proper procedure for backwashing filters is very important. This is a typical procedure for backwashing a sand filter. However, the operator should always follow manufacturer's instructions to avoid possible damage to the underdrain or media bed. (See Figure 12.22 - *Filter Backwash Valve Positions.*)

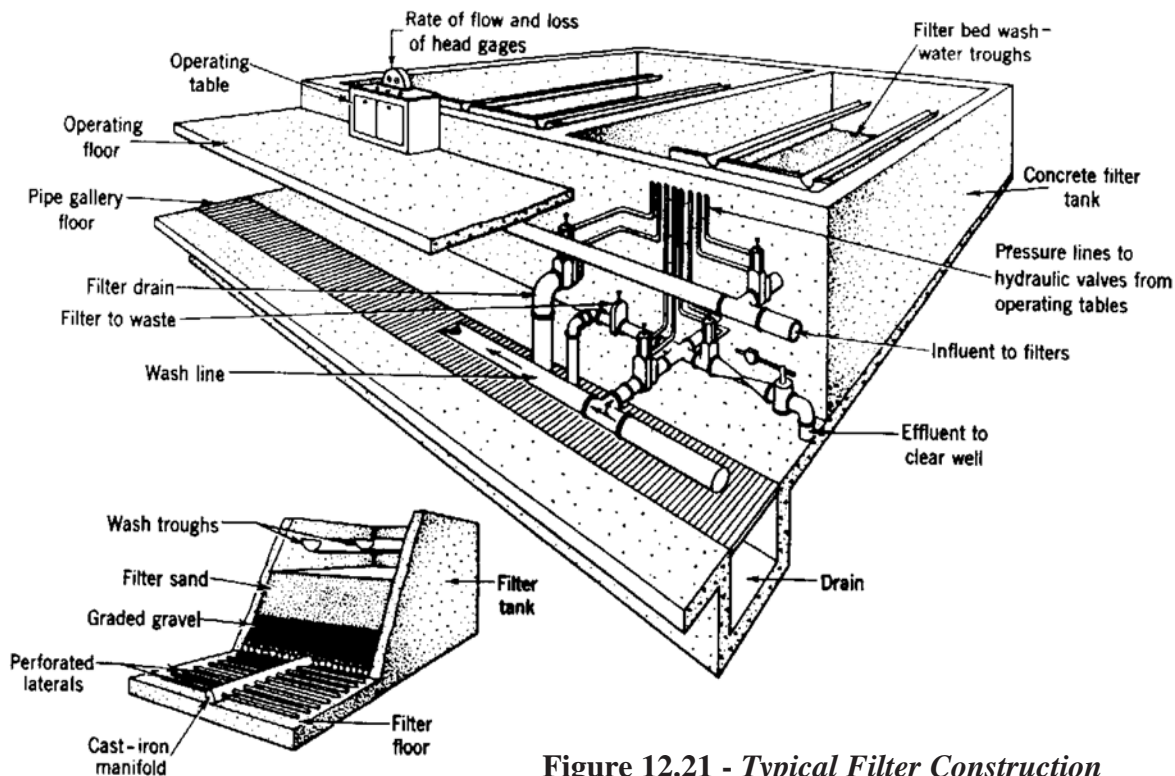

Figure 12.21 - Typical Filter Construction

### FILTER OPERATION

Rapid sand filters are designed to filter water at a rate of 2 gpm/sq.ft. of filter area. A clean filter will have a small amount of head loss (2-6"), but as the filter run continues the head loss will steadily build up. When head loss reaches 8 feet the filter should be backwashed. Running a filter at a

### FILTER BACKWASHING PROCEDURES

1. The filter is taken out of service by closing the influent valve and letting the water filter down to about 6 inches from the top of the sand.
2. Open the drain or waste valve.
3. Slowly open the surface wash valve until it is operating at full efficiency.
4. Once the surface wash valve is fully open, begin

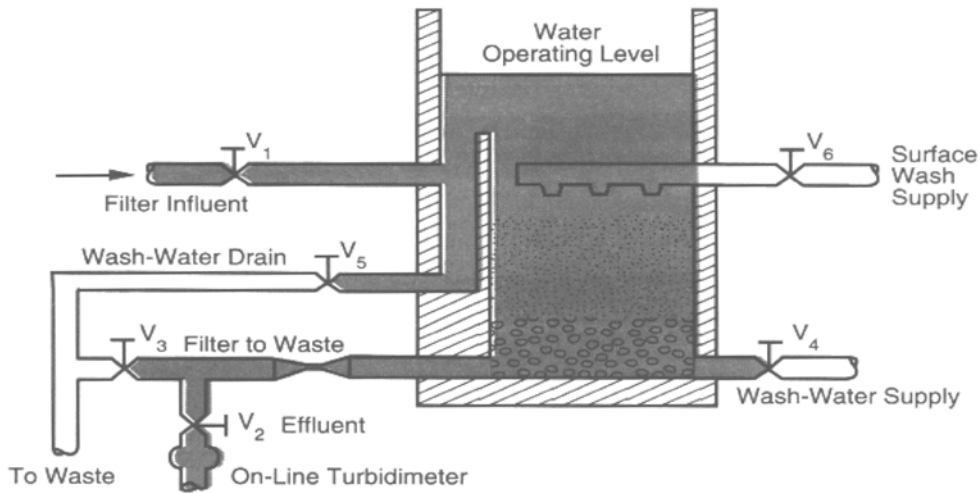

**Valve Position During Filtration**

Valve	Filtering	Backwashing	Filtering to Waste
V <sub>1</sub> — Influent	Open	Closed	Open
V <sub>2</sub> — Effluent	Open	Closed	Closed
V <sub>3</sub> — Filter to Waste	Closed	Closed	Open
V <sub>4</sub> — Wash-Water Supply	Closed	Open	Closed
V <sub>5</sub> — Wash-Water Drain	Closed	Open	Closed
V <sub>6</sub> — Surface Wash Supply	Closed	Open	Closed

**Figure 12.22 - Filter Backwash Valve Positions**

opening the backwash water valve very slowly until the optimum wash rate has been reached. If the filter is air bound the filter wash water valve should only be opened enough to bleed the air off. The filter should not be backwashed at the normal flow until all the air has been purged. Opening the backwash water valve too fast will “surge” the filters resulting in damage to the underdrain and media. If the backwash water is not evenly distributed, gravel support media may be displaced in the areas of higher flow.

5. After a few minutes close the surface wash valve.
6. When the wash water begins to clear, the backwash water valve should be closed slowly.
7. Close the drain valve
8. Open the influent valve about 10% to 25% so the filter fills slowly.
9. When the water reaches the top of the back wash trough, open the filter to waste valve and allow the filter to run for about 30 minutes to waste.
10. Close the filter to waste valve and open the effluent valve to put the filter back in service.

The backwash rate for sand filter should be 15 gpm/sq.ft. of filter area. This flow rate is needed to expand the sand bed 30-50% in order to separate the sand grains so that they can be thoroughly cleaned. Always continue to backwash until the wash water is clean. Failure to do so can result in the formation of mud balls. Once mud balls form, the only way they can be removed is by removing

and replacing the filter media. If a backwash flow meter is not provided, a simple hook gauge can be used to determine the backwash rate.

A hook gauge is made using a length of board with nails or hooks driven into it that are 6 inches apart. The gauge is then placed on the side of the filter with the bottom hook just above the top of the backwash trough. While backwashing the filter, the waste valve is closed. The amount of time it takes for the surface of the water to rise from the point of one hook to the point of the other hook is measured. The waste valve must be opened immediately after the test to prevent the filter from overflowing. A wash water rate of 15 gpm/sq.ft. will cause the water level over the sand to rise 6 inches in 15 second or 24 inches in one minute, since 2 cubic feet of water is about 15 gallons.

**TROUBLESHOOTING FILTER PROBLEMS**

There are three basic operational problems associated with filter operations. Although they have been mentioned before, here is a list of the problems and causes:

**FILTER BREAKTHROUGH**

Identified by a sudden increase in effluent turbidity. Filter Breakthrough is caused by running the filter at too high a filtration rate or too long a run time. This causes cracking and media separation from the filter wall.

### AIR BINDING

Identified by abnormally high head loss on recently backwashed filters. Air Binding is caused by running a filter at too high a head loss. This creates low pressures in the filter resulting in the release of dissolved gases that become trapped in the filter bed or underdrain.

### MUD BALLS

Identified by shortened filter runs and loss of filter capacity. Mud balls are created when the filter is not properly backwashed. The flow rate may have been too low or it was not backwashed long enough.

### CLEANING FILTER BEDS

Sometimes filter media becomes coated with scale from the chemical treatment processes. Algae can also buildup in outdoor filters that are exposed to sunlight. If this becomes severe the filter may have to be taken out of service so that the media can be chemically cleaned. Sodium hydroxide is used to dissolve alum deposits. Hydrochloric acid is used to dissolve lime deposits. Chlorine or oxidizing agents are used to kill algae growth.

### HIGH RATE FILTERS

Recent designs have included the use of different types of filter media other than sand in an effort to increase filtration rates and lengthen filter runs. Using two or more types of media with different particle sizes allows filterable solids to penetrate deeper into the filter bed. This allows the filter to be operated at higher flows. These filters are referred to as high rate filters

The most common type of media used in high rate filters, other than silica sand, is anthraflit. Anthraflit is anthracite coal screenings that are larger than filter sand. Particle size will be about 0.60 to 0.70 mm as compared to silica sand media of 0.40 to 0.60 mm. Some advantages of using anthraflit media are higher filtration rates, longer filter runs, and less coating of the grains with lime and other materials. It is important that the backwash velocity be carefully controlled to prevent the anthraflit from being carried over into the wash troughs and out of the filter box. Anthraflit filters require at least 32 inches of free board on the backwash troughs because of its lighter weight.

Dual-media filters use a filter bed of both anthracite coal and silica sand. There is usually 12-18 inches of coal on top of 8-12 inches of sand. The upper layer of the lighter and coarser anthracite has voids about 20% larger than the sand, resulting in a larger to smaller grading of the media in the direction of flow. Dual media filters have a filter rate of 3-5 gpm/sq.ft. After backwashing, the filter media separates with the heavier sand falling to the bottom and the lighter coal on top. The larger floc particles are trapped in the surface of the coal layer while the finer particles are held in the sand. This creates deeper particle penetration into the filter bed and allows higher filtration rates.

Multi-media filter beds using coal, silica sand, and garnet sand provide the highest filtration rate of any gravity filter. Filter rates for multi-media filters are from 5-8 gpm/sq.ft. Garnet sand, has a specific gravity of about 4.2, which is greater than coal (1.6 S.G.) or silica sand (2.6 S.G.). A multi-media filter bed will consist of 4-6 inches of garnet sand on the bottom, 8-10 inches of silica sand in the middle, and 12-18 inches anthracite coal on top. Because of the

difference in specific gravities, separation of the different media occurs after backwashing with little intermixing. A typical mixed media filter has particle sizing gradually decreasing from about 0.7 mm at the top to 0.2 mm at the bottom. In addition to gravity filters, mixed media filters are also being used in pressure filters.

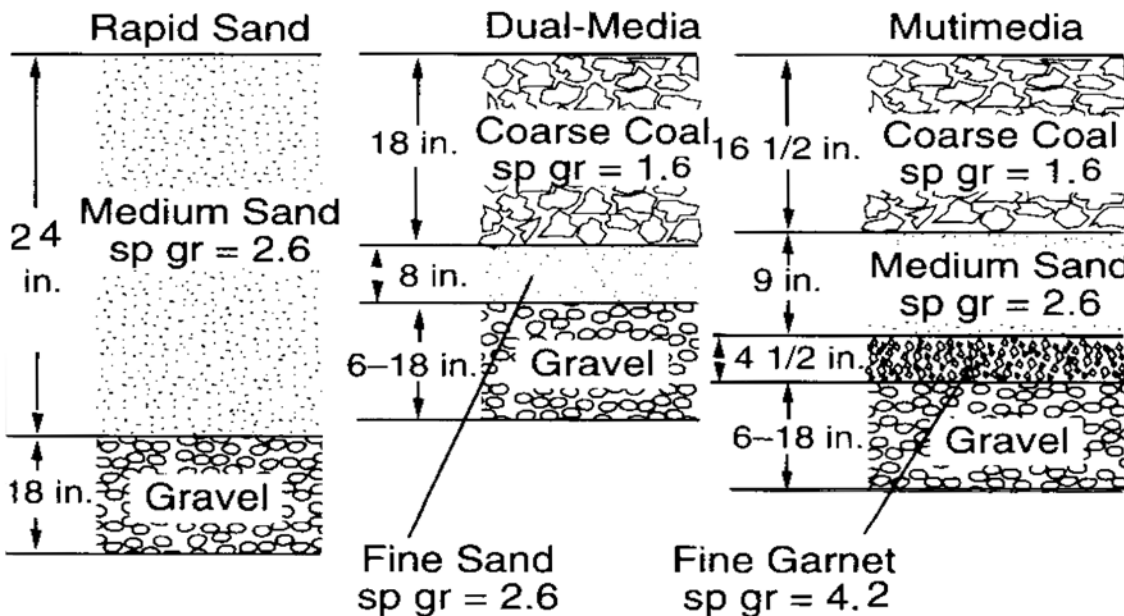

Figure 12.23 - Filter Media Configurations

---

## References

Office of Water Programs, California State University, Sacramento, *Water Treatment Plant Operation*, 4<sup>th</sup> ed., 1999, Vol. 1, Chapters 1, 2, 3, 4, 5, 6, 8, & 9.

Office of Water Programs, California State University, Sacramento, *Water Treatment Plant Operation*, 3<sup>rd</sup> ed., 1999, Vol. 2, Chapters 1, 9, & 14.

ACR Publications, Inc., Skeet Arasmith, *Introduction to Small Water Systems*, Chapter 4.

---

## COAGULATION AND FLOCCULATION

### ADVANCED STUDY QUESTIONS

1. What is a coagulant aid?
2. What is the detention time for a rapid mixer?
3. What type of polymer will attract negatively charged turbidity particles?
4. What is hydraulic shear in a flocculator?
5. How do colder temperatures affect coagulation and flocculation?

### ADVANCED SAMPLE TEST QUESTIONS

1. Which two chemicals are used to remove turbidity?
  - A. Soda Ash and lime
  - B. Copper sulphate and caustic soda
  - C. Alum and lime
2. Which of the following is considered to be a coagulant aid?
  - A. Lime
  - B. Polymer
  - C. Bentonite
  - D. All of the above
3. Alum precipitates as
  - A. Aluminum carbonate
  - B. Aluminum sulphate
  - C. Aluminum hydroxide
4. Turbidity removal with alum is best accomplished at what pH?
  - A. 3.5
  - B. 5.0
  - C. 6.5
5. Which of the following will not lower the pH?
  - A. Alum
  - B. Carbonic acid
  - C. Ferric chloride
  - D. Sodium carbonate

## TASTES AND ODORS

### ADVANCED STUDY QUESTIONS

1. What is the best way to remove organic tastes and odors?
2. What types of tastes and odors can be removed by aeration?
3. Which kinds of algae cause most of the organic tastes and odors?

### ADVANCED SAMPLE TEST QUESTIONS

1. Pre-chlorination to remove tastes and odors can result in the formation of carcinogenic compounds called
  - A. Colloids
  - B. THM's (Trihalomethanes)
  - C. NTU's
2. Which type of algae will cause problems by clogging the filter bed?
  - A. Green
  - B. Diatoms
  - C. Blue-green
  - D. Brown
3. The chemical used to kill algae in a lake is:
  - A. Alum
  - B. Copper sulphate
  - C. Caustic soda
  - D. Carbonic acid
4. Activated carbon should be added:
  - A. After sedimentation
  - B. As far upstream of coagulation as possible
  - C. In the flash mixer
  - D. After disinfection

## **IRON AND MANGANESE**

### **ADVANCED STUDY QUESTIONS**

1. What color is associated with manganese problems?
2. What other treatment process is required if iron is removed by aeration?
3. What is a sequestering agent?

### **ADVANCED SAMPLE TEST QUESTIONS**

1. Iron can be a problem for water systems when the concentration exceeds:
  - A. 0.05 mg/l
  - B. 0.3 mg/l
  - C. 3.0 mg/l
  - D. 10 mg/l
2. Which of the following is a sequestering agent?
  - A. Calgon
  - B. Sodium hexametaphosphate
  - C. Polyphosphates
  - D. All of the above
3. Enough Calgon should be added to keep iron from oxidizing for:
  - A. 2 days
  - B. 4 days
  - C. 6 days

## **SEDIMENTATION**

### **ADVANCED STUDY QUESTIONS**

1. Why are baffles important in a sedimentation basin?
2. What is the detention time for a sedimentation basin?
3. What can happen when sludge is not removed often enough?
4. Why is the weir overflow rate important?
5. What type of device protects the sludge removal equipment in a sedimentation basin?

### **ADVANCED SAMPLE TEST QUESTIONS**

1. An upflow clarifier will have which of the following processes?
  - A. Coagulation
  - B. Flocculation
  - C. Sedimentation
  - D. All of the above
2. Sludge that rises to the surface of a sedimentation basin is caused by:
  - A. Not removing sludge often enough
  - B. Removing sludge too often
  - C. pH is too low
  - D. Surface loading rate is too low

3. Pin floc leaving a sedimentation basin may indicate a problem with:
  - A. Coagulation
  - B. Flocculation
  - C. Sedimentation
  - D. Disinfection

## **FILTRATION**

### **ADVANCED STUDY QUESTIONS**

1. What are the three kinds of gravity filters?
2. What is the primary function of the filter underdrain?
3. What causes air binding in a filter?
4. What is freeboard in a filter?
5. What does the uniformity coefficient mean regarding filter media sand?

### **ADVANCED SAMPLE TEST QUESTIONS**

1. What is the backwash rate for a rapid sand filter?
  - A. 2 gpm/sq.ft.
  - B. 15 gpm/sq.ft.
  - C. 20 gpm/sq.ft.
  - D. 25 gpm/sq.ft.
2. What is the maximum run time for a gravity filter?
  - A. 8 hours
  - B. 20 hours
  - C. 48 hours
  - D. 100 hours
3. During backwash, the filter bed should expand:
  - A. 5-10%
  - B. 15-20%
  - C. 30-50%
  - D. 60-80%
4. If the backwash time is too short, what may result?
  - A. Too much freeboard
  - B. Mudballs
  - C. Loss of filter media
  - D. Filter breakthrough
5. If the filtration rate is too high, what may result?
  - A. Filter breakthrough
  - B. Mudballs
  - C. Reduction in operating costs
  - D. Lower headloss

BLANK PAGE



## CHAPTER 13: SAFETY

---

Based on past studies, the water and wastewater industry has one of the highest injury rates in the nation. Workers in these areas are involved in construction and excavations, confined spaces, hazardous chemicals, and mechanical equipment that pose a serious injury risk when proper training, equipment, and procedures are not utilized. The Occupational Safety and Health Administration (OSHA) is responsible for developing regulations regarding worker safety and protection.

Employers are responsible for providing employees with the proper safety equipment and training in its use. They are also responsible for development and implementation of safety policies for their workplace. The employees, after proper training, are responsible for recognizing the safety issues; following approved safety procedures, and properly utilizing the associated safety equipment.

### LOCK OUT/TAG OUT (LOTO)

Lock out/tag out regulations deal with the need to isolate a machine from its energy source to prevent it from starting while work is being done in and around the equipment. Energy sources can include electrical energy, hydraulic energy, pneumatic energy, thermal energy, and chemical energy. This can be either active energy or stored energy. Stored energy can take many forms. Some examples of stored energy are; electrical energy stored in capacitors, pneumatic energy stored in a compressor tank, and hydraulic water pressure in an isolated line. Any stored energy must be dissipated prior to working on the equipment. Employers are responsible for establishing an "Energy Control Plan" for LOTO work and supply each worker with their individual LOTO locking devices.

LOTO requires workers to isolate and de-energize these sources and lock and tag them prior to working on the equipment or process. Only trained personnel should conduct lock out/tag out procedures. Each individual involved in the work should attach their personal LOTO lock to the disconnect or isolation device. This assures that the equipment cannot be restarted until each individual is finished with their task and is clear of the equipment.

Tags are used to provide information regarding the date and nature of the lockout and the individual responsible for removing the lockout. Tags are not substitutes for locks. Any isolation that can be locked must be locked and tagged. Lockout devices may also include chains, valve clamps, wedges, jacks, or key blocks.

Anyone who enters a LOTO work area must be informed that a LOTO situation exists. If they are to be involved in the work, they must also apply their own LOTO locks. Workers that leave a LOTO site must take their LOTO locks with them. If work is not completed at the end of a shift, all LOTO locks must be removed and be replaced with an equipment protection lock until work resumes. If equipment must be temporarily restarted, the LOTO must be removed during the restart and reapplied before work can continue.

### CONFINED SPACE ENTRY

The water and wastewater industry has one of the highest numbers of confined space injuries per capita in the country. The vast majority of confined space related injuries result in fatalities. Another disturbing fact is that 40% of the confined space related fatalities are people who tried to rescue someone else from a confined space.

A confined space is defined by the following parameters. It must be large enough for a person to enter and do work. It has openings that make entry or exit difficult. It is not intended for continuous occupancy. Any open surface tank that is deeper than four feet is also considered a confined space.

Confined spaces fall into two categories; permit required and non-permit required. A confined space becomes permit required when it has potential for a hazardous atmosphere, potential for engulfment, a hazardous internal configuration, or other recognized hazards such as dangerous equipment or hot work (welding, cutting torch, etc.) that is in progress.

All employees involved in confined space entries must have the proper training in entry procedures and use of safety equipment. An entry supervisor is responsible for conducting the testing and completing the permit. Atmospheric testing should include oxygen concentration, Lower Explosive Limit for explosives, and any toxic gases that may be present. The oxygen concentration must be between 19.5-23.5%. The alarm point for explosives is 10% of Lower Explosive Limit (LEL).

An attendant must be present and stationed outside the confined space to monitor the entrants while they are working. The attendant must maintain constant verbal and visual communications with the entrants. The attendant must also be prepared to instruct the entrants to exit the confined space should the equipment fail or the entrants exhibit impaired judgement.

Any confined space must be tested for a hazardous atmosphere before the entry. Monitoring must continue while the entrants are in the confined space. Permit required confined spaces also require ventilation during the entry and self-contained or supplied air must be used if ventilation fails to produce a safe atmosphere. Permit required confined space entries also require rescue equipment such as a harness and tripod for emergency rescues. If the space is configured in a way that prevents the use of self-rescue equipment, an emergency rescue team must be on-site during the entry. When the entry is completed, the entry supervisor must complete the permit form and file a copy with the appropriate supervisor and a confined space entry master file. Non-permit confined spaces must be reassessed periodically. Any non-permit space can be reclassified, as permit required, based on the results of these assessments.

### HAZARD COMMUNICATION STANDARD

OSHA established the Hazard Communication Standard in 1986. The standard was created to provide an information system on hazardous chemicals for both employers and employees. The Haz-Com Standard requires employers to ensure their employees know what hazardous materials exist in the workplace, how to safely use these materials, and how to deal with any emergencies that arise during use. Employers are required to provide the proper safety equipment, train employees in the safe use of any hazardous materials on a jobsite, and maintain records of both.

Producers of hazardous materials are required to provide customers with a Material Safety Data Sheet (MSDS) for each individual chemical or material. MSDS's must be kept on file and available to employees. Employee training should also include how to read and understand the information on the MSDS. The hazards that are involved fall into two basic categories:

- Health Hazards
- Physical hazards

Health hazards refer to immediate or long-term harm to the body caused by exposure to hazardous chemicals. Physical hazards like flammability or corrosivity can also cause injury to skin, eyes and the respiratory system. MSDS's are divided into eight sections.

### NFPA COLOR-CODE WARNING SYSTEM

OSHA uses a system based on the National Fire Protection Association (NFPA) diamond warning symbol as part of the MSDS information. This code is also required for all container labels. The NFPA symbol has four color-coded diamond-shaped sections. The top (red) diamond is the

**Table 13.1 - (MSDS) Sections**

<b>Material Safety Data Sheet (MSDS) Sections</b>	
1.	Manufacturers Contact Information
2.	Hazardous Ingredients/Identity Information
3.	Physical/Chemical Characteristics
4.	Fire and Explosion Hazard Data
5.	Reactivity Data
6.	Health Hazard/First Aid Information
7.	Precautions for Safe Handling and Use
8.	Control/Cleanup Measures

Flammability Hazard rating. The left (Blue) diamond is the Health Hazard rating. The right (yellow) diamond is the Reactivity Hazard rating. The bottom (White) diamond contains special symbols to indicate properties not explained by the other categories. A number-based rating system is used for each section, ranging from 0 – least dangerous to 4 – extremely dangerous.

**Table 13.2 - Other Hazard Symbols**

<b>Other Hazard Symbols</b>	
Acid	Acid
Base	Alkalis, cyanides
Oxy	Oxidizers
Flam	Flammables
Rad	Radioactive
W-	Use no water

### EXCAVATION SAFETY

Proper shoring or sloping of trenches and excavations is a major safety issue for many distribution system operators. New construction usually involves more controlled conditions than emergency repairs. Excavations for emergency repairs almost always involve digging and shoring in saturated soils and flooded trenches. A “competent person” must supervise all excavation operations. A competent person is someone who has extensive training in soil mechanics and shoring operations.

All trenches over 4 feet deep must have ladder from entry and exit. The ladders must extend at least 3 feet above the top of the trench and ladders must not be stationed more

than 25 feet apart. Trenches over 5 feet deep must be properly shored or sloped to protect entrants from trench wall collapse and cave-ins. The competent person must determine the proper Maximum Allowable Slope, formerly referred to as Angle of Repose, for the given soils type. Soils are either Type 1,2, or 3. Type 3 soils are the least stable and require the shallowest Maximum Allowable Slope. Spoil from the excavation must be placed at least 2 feet from the edge of the excavation (farther with more unstable soils.)

Shoring must be installed without worker entry into the excavation. Trench boxes are useful for long trenches where it can be moved along the trench. This saves some of the setup and breakdown time required with shoring. Ladders must be positioned so that workers can enter and exit without stepping outside the shoring or trench box. Excavations may become confined spaces if they are located close to a source of potentially hazardous gases (underground gas tanks, landfills, etc.)

---

### References

Office of Water Programs, California State University, Sacramento, *Water Treatment Plant Operation*. 4<sup>th</sup> ed., 1999, Vol. 2, Chapter 20  
Office of Water Programs, California State University, Sacramento, *Small Water Systems O&M*, 4<sup>th</sup> ed., 2001, Chapters 6  
Office of Water Programs, California State University, Sacramento, *Water Distribution Systems O&M*, 4<sup>th</sup> ed., 2000, Chapters 7.

---

### BASIC STUDY QUESTIONS

1. What does locking out a piece of equipment mean?
2. What must be done prior to entering a confined space?
3. What is the maximum allowable depth of an unshored excavation?

### BASIC SAMPLE TEST QUESTIONS

1. Ladders must extend at least \_\_\_ feet above the trench?
  - A. 1
  - B. 2
  - C. 3
  - D. 4

2. An attendant must be stationed outside every confined space entry.
  - A. True
  - B. False
3. Each worker must attach a LOTO lock on a locked out machine.
  - A. True
  - B. False

### ADVANCED STUDY QUESTIONS

1. What kinds of training should employees receive regarding hazardous materials?
2. What is the lower limit for oxygen concentrations in confined spaces?
3. What types of energy sources must be isolated during lock out/ tag out?

### ADVANCED SAMPLE TEST QUESTIONS

1. What types of materials pose a physical hazard?
  - A. Flammables
  - B. Acids
  - C. Oxidizers
  - D. All of the above
2. Which type of soil requires the shallowest Maximum Allowable Slope or the widest trench?
  - A. Type 1
  - B. Type 2
  - C. Type 3
3. Which of the following statements is true regarding excavation shoring?
  - A. Shoring must be installed and removed from outside the trench.
  - B. A competent person must supervise the installation of the shoring devices.
  - C. Ladders must be located inside the shoring.
  - D. All of the above

BLANK PAGE

# CHAPTER 14: MATHEMATICS FOR WATER OPERATORS

The understanding of the mathematics of water hydraulics (flows, pressures, volumes, horsepower, velocities) and water treatment (detention time, chemical dosage) is an important tool for all water system operators. This chapter covers most of the major categories of math calculations that are important to know for both certification and daily operations of water systems. The examples range from basic problems, that might appear on a Class 1 or 2 exam, to more complex problems that could be found on a Class 3 or 4 exam. The advanced levels will also have more problems related to water treatment processes like dosage problems and detention time problems.

## PRESSURE

Water pressure is measured in terms of pounds per square inch (psi) and feet of head (height of a water column in feet). A column of water 2.31 feet high creates a pressure of 1 psi. The water pressure at the bottom of a storage tank can be used to determine the water level in the tank. Centrifugal pumps are rated in feet of Total Dynamic Head (TDH) but system pressures are measured in psi. All water system operators must be able to convert from one pressure unit to the other.

If the pressure (psi) is known, the height of the water column can be determined by multiplying the psi by 2.31.

$$\text{psi} \times 2.31 = \text{Feet of Head}$$

### EXAMPLE:

A pressure gauge at the bottom of a storage tank reads 30 psi. What is the water level in the tank?

- Convert psi to feet of head

$$30 \text{ psi} \times 2.31 = \mathbf{69.3 \text{ feet of water above the gauge}}$$

If the height of a column of water is known, the pressure it exerts can be determined by dividing the feet of head by 2.31.

$$\frac{\text{Feet of Head}}{2.31} = \text{psi}$$

### EXAMPLE:

The reservoir level is 115 feet above the pump discharge. What is the discharge pressure on the pump?

- Convert feet of head to psi.

$$\frac{115 \text{ feet}}{2.31} = \mathbf{49.8 \text{ psi}}$$

Advanced questions may require you to calculate the feet of head or psi before it can be converted.

### EXAMPLES:

A pump is installed at 5320 feet above sea level. The overflow of the reservoir is at 5460 feet above sea level. What is the discharge pressure on the pump in psi?

- Find the difference in elevation

$$5460 \text{ feet} - 5320 \text{ feet} = 140 \text{ feet of head}$$

- Convert feet of head to psi

$$\frac{140 \text{ feet}}{2.31} = \mathbf{60.6 \text{ psi}}$$

A discharge pressure gauge on a pump reads 72 psi when the pump is running. The pressure gauge at the top of a hill 40 feet above the pump reads 45 psi. What is the friction loss in the pipe in feet of head?

- Find the difference in the pressures

$$72 \text{ psi} - 45 \text{ psi} = 27 \text{ psi}$$

- Convert psi to feet of head

$$27 \text{ psi} \times 2.31 = 62.4 \text{ feet of head}$$

- Subtract the difference in elevation to find the friction loss

$$62.4 \text{ feet} - 40 \text{ feet} = \mathbf{22.4 \text{ feet of head}}$$

## FLOW

The amount of water moving through the system can be measured in one of three different units. They are gpm (gallons per minute), mgd (millions of gallons per day), and cfs (cubic feet per second). The conversions are listed below.

$$\text{mgd} \times 700 = \text{gpm} \quad \frac{\text{gpm}}{700} = \text{mgd}$$

$$\text{cfs} \times 449 = \text{gpm} \quad \frac{\text{gpm}}{449} = \text{cfs}$$

### EXAMPLES:

A system uses 2 mgd. How many gallons per minute does it use?

- Convert mgd to gpm

$$2 \text{ mgd} \times 700 = \mathbf{1400 \text{ gpm}}$$

A pipeline has a carrying capacity of 3 cfs. How many gpm can it handle?

- Convert cfs to gpm

$$3 \text{ cfs} \times 449 = \mathbf{1347 \text{ gpm}}$$

A well pumps 350 gpm. How many mgd will it pump?

- Convert gpm to mgd

$$\frac{350 \text{ gpm}}{700} = \mathbf{0.5 \text{ mgd}}$$

## AREAS

In order to calculate volumes of circular tanks and velocities in pipes, the area of the circle must first be determined. There are two basic formulae used to calculate the area of a circle.

$$\begin{array}{ll} \text{Area} = 3.1416 \times r^2 & \text{Area} = d^2 \times 0.785 \\ r = \text{radius} & d = \text{diameter} \end{array}$$

### EXAMPLES:

A sedimentation basin is 60 feet in diameter. What is the surface area of the tank?

- Calculate the area

$$\begin{array}{l} 3.1416 \times 30' \times 30' = \mathbf{2830 \text{ square feet}} \\ 60' \times 60' \times 0.785 = \mathbf{2830 \text{ square feet}} \end{array}$$

A pipeline has diameter of 12 inches. What is the area of the pipe?

- Calculate the area

$$\begin{array}{l} 3.1416 \times 6'' \times 6'' = \mathbf{113 \text{ square inches}} \\ 12'' \times 12'' \times 0.785 = \mathbf{113 \text{ square inches}} \end{array}$$

## VOLUMES

The volume of a rectangular tank can be determined by multiplying the length, height, and width together.

$$\text{Volume of rectangular tank (ft}^3\text{)} = L' \times H' \times W'$$

### EXAMPLE:

A sedimentation basin is 60' long by 40' wide and 10' deep. What is the volume of the tank in cubic feet?

- Calculate the volume

$$60' \times 40' \times 10' = \mathbf{24,000 \text{ cubic feet (ft}^3\text{)}}$$

The volume of a circular tank can be determined by multiplying the area of the by the height (or depth) of the tank.

$$\text{Volume of circular tank (ft}^3\text{)} = 3.1416 \times r'^2 \times H'$$

or

$$\text{Volume of circular tank (ft}^3\text{)} = d'^2 \times 0.785 \times H'$$

### EXAMPLE:

A sedimentation basin is 60' in diameter and 12' deep. What is the volume of the tank?

- Calculate the volume

$$\begin{array}{l} 3.1416 \times 30' \times 30' \times 12' = \mathbf{33,900 \text{ cubic feet (ft}^3\text{)}} \\ \text{or} \\ 60' \times 60' \times 0.785 \times 12' = \mathbf{33,900 \text{ cubic feet (ft}^3\text{)}} \end{array}$$

## VOLUMES IN GALLONS

It is often necessary to calculate a volume of a tank or pipe in gallons rather than cubic feet. In most cases the volume must be calculated in cubic feet and then converted into

gallons. This is determined by multiplying cubic feet by 7.48.

$$\text{Cubic feet} \times 7.48 = \text{gallons}$$

### EXAMPLE:

A sedimentation basin is 60' long by 40' wide and 10' deep. What is the volume of the tank in cubic feet?

- Calculate the volume

$$60' \times 40' \times 10' = 24,000 \text{ ft}^3$$

- Convert cubic feet to gallons

$$24,000 \text{ ft}^3 \times 7.48 = \mathbf{179,500 \text{ gallons}}$$

A circular tank has a diameter of 40 feet and is 10 feet deep. How many gallons will it hold?

- Calculate the volume

$$3.1416 \times 20' \times 20' \times 10' = 12,600 \text{ ft}^3$$

or

$$40' \times 40' \times 0.785 \times 10' = 12,600 \text{ ft}^3$$

- Convert cubic feet to gallons

$$12,600 \text{ ft}^3 \times 7.48 = \mathbf{94,200 \text{ gallons}}$$

## VOLUMES OF PIPES

The number of gallons contained in a one-foot section of pipe can be determined by squaring the diameter (in inches) and then multiplying by 0.0408. To determine the number of gallons in a particular length of pipe multiply the gallons per foot by the number of feet of pipe.

$$\text{Volume (gal)} = D''^2 \times 0.0408 \times \text{Length}'$$

### EXAMPLES:

A 12" line is 1100 ft long. How many gallons does the pipe hold?

- Find the volume of the pipe in gallons

$$12'' \times 12'' \times 0.0408 \times 1100 = \mathbf{6460 \text{ gallons}}$$

A 6" line is 654 ft long. How many gallons does the pipe hold?

- Find the volume of the pipe in gallons

$$6'' \times 6'' \times 0.0408 \times 654 = \mathbf{960 \text{ gallons}}$$

## VELOCITY

The velocity of the water moving through a pipe can be determined if the flow in cubic feet per second (cfs) and the diameter of the pipe (inches) are known. The area of the pipe must be calculated in square feet (ft<sup>2</sup>) and the flow is then divided by the area.

$$\frac{\text{Velocity (fps)}}{\text{Area (ft}^2\text{)}} = \text{Flow (cfs)}$$

**EXAMPLE:**

A 24" pipe carries a flow of 11 cfs. What is the velocity in the pipe?

- Change diameter in inches to feet

$$24"/12" \text{ per ft} = 2 \text{ ft.}$$

- Find area of the pipe in sq.ft.

$$1 \times 1 \times 3.1416 = 3.14 \text{ sq.ft.}$$

- Find the velocity in fps

$$\frac{11 \text{ cfs}}{3.14 \text{ sq.ft.}} = 3.5 \text{ fps}$$

The flow through a pipe (cfs) can be determined if the velocity and pipe diameter are known. The area of the pipe must be calculated in square feet and then multiplied by the velocity (fps.)

**EXAMPLES:**

A 12" pipe carries water at a velocity of 5.0 fps. What is the flow in cfs?

- Change inches to ft.

$$12"/12" \text{ per ft} = 1 \text{ ft.}$$

- Find area of the pipe in sq.ft.

$$0.5 \times 0.5 \times 3.1416 = 0.785 \text{ sq.ft.}$$

- Find the flow in cfs

$$5.0 \text{ fps} \times 0.785 \text{ sq.ft.} = 3.9 \text{ cfs}$$

A 12" pipe carries 1400 gpm at 4.0 fps velocity and reduces to a 6" pipe. What is the velocity in the 6" pipe?

- Convert flow to cfs

$$\frac{1400 \text{ gpm}}{449 \text{ gpm/cfs}} = 3.12 \text{ cfs}$$

- Change inches to ft.

$$6"/12" \text{ per ft} = 0.5 \text{ ft.}$$

- Find area of the pipe in sq.ft.

$$0.25' \times 0.25' \times 3.1416 = 0.196 \text{ sq.ft.}$$

- Find the velocity in fps

$$\frac{3.12 \text{ cfs}}{0.196 \text{ sq.ft.}} = 16 \text{ fps}$$

**DETENTION TIME**

Detention time (D.T.) is the length of time in minutes or hours for one gallon of water to pass through a tank. To calculate detention time, the capacity of a tank in gallons is divided by the flow in gallons per minute (gpm) or gallons per day (gpd). If gpm is used, the answer will be in minutes and must be divided by 60 minutes to get hours. If gpd is used, the answer will be in days and must be multiplied by 24 hours. The detention time formula can also be used to calculate how long it will take to fill a tank.

**EXAMPLES:**

A 50,000 gallon tank receives 250,000 gpd flow. What is the detention time in hours?

- Find detention time in days

$$\frac{50,000 \text{ gal.}}{250,000 \text{ gal/day}} = 0.2 \text{ days}$$

- Change days to hours

$$0.2 \text{ days} \times 24 \text{ hrs/day} = 4.8 \text{ hours}$$

A tank is 60' x 80' x 10' and the flow is 2.0 mgd? What is the detention time in hours?

- Find Volume in cubic feet

$$60' \times 80' \times 10' = 48,000 \text{ cu.ft.}$$

- Change cubic feet to gallons

$$48,000 \text{ cu.ft.} \times 7.48 \text{ gal/cu.ft.} = 359,000 \text{ gal.}$$

- Change mgd to gal/day

$$2.0 \text{ mgd} = 2,000,000 \text{ gal/day}$$

- Find D.T. in days

$$\frac{359,000 \text{ gal.}}{2,000,000 \text{ gal/day}} = 0.18 \text{ days}$$

- Change days to hours

$$0.18 \text{ days} \times 24 \text{ hrs/day} = 4.3 \text{ hours}$$

A tank is 100' in diameter and 22 feet deep. If the flow into the tank is 1500 gpm and the flow out of the tank is 300 gpm, how many hours will it take to fill the tank?

- Calculate the volume in cubic feet

$$3.1416 \times 50' \times 50' \times 22' = 173,000 \text{ ft}^3$$

or

$$100' \times 100' \times 0.785 \times 22' = 173,000 \text{ ft}^3$$

- Change cubic feet to gallons

$$172,800 \text{ ft}^3 \times 7.48 = 1,290,000 \text{ gallons}$$

- Calculate the net inflow

$$1500 \text{ gpm} - 300 \text{ gpm} = 1200 \text{ gpm}$$

- Calculate how long until full (detention time)

$$\frac{1,290,000 \text{ gal}}{1200 \text{ gpm}} = 1075 \text{ minutes}$$

$$1200 \text{ gpm}$$

- Change minutes to hours

$$\frac{1075 \text{ min}}{60 \text{ min/hr}} = 17.9 \text{ hours}$$

$$60 \text{ min/hr}$$

**DOSAGE**

Chemical dosages are measured in ppm (parts per million) or mg/l (milligrams per liter.) Parts per million (ppm) is always a comparison of weight (pounds per million pounds). One pound of chemical added to one million pounds of water would be a dosage of 1 ppm. Since each gallon of water weighs 8.34 pounds, one million gallons of water weighs 8.34 million pounds and would require 8.34 pounds of chemical to obtain a dosage of 1 ppm. Milligrams per liter (mg/l) is the metric term for a dosage equal to ppm.

$$1 \text{ gallon} = 8.34 \text{ lbs.}$$

$$1 \text{ ppm} = 1 \text{ mg/l}$$

The number of pounds of chemical needed to achieve a certain dosage can be determined by multiplying the ppm by the number of millions of gallons treated and then by 8.34 lbs/gal. The amount of water to be treated must always be in terms of millions of gallons (mgd).

$$mg/l \times mgd \times 8.34 = \text{pounds per day}$$

**EXAMPLE:**

How many lbs/day of chlorine are needed to provide a dosage of 2.2 mg/l in 800,000 gal/day?

- Change gal/day to mgd  
 $800,000 \text{ gpd} = 0.8 \text{ mgd}$
- Calculate lbs/day  
 $2.2 \text{ mg/l} \times 0.8 \text{ mgd} \times 8.34 = \mathbf{14.7 \text{ lbs/day}}$

If HTH is used, instead of chlorine gas, only 65-70% of each pound will be chlorine. Therefore, the amount of HTH must be calculated by dividing the pounds of chlorine needed by 0.65 or 0.70.

**EXAMPLES:**

A tank is 44' in diameter and 22' high and is dosed with 50 ppm of chlorine. How many pound of 70% HTH is needed?

- Find the volume of the tank in cubic feet  
 $22' \times 22' \times 3.1416 \times 22' = 33,450 \text{ cu.ft.}$
- Change cu.ft. to gallons  
 $33,450 \times 7.48 = 250,000 \text{ gallons}$
- Change gallons to mgd  
 $250,000 \text{ gallons} = 0.250 \text{ mgd}$
- Find lbs of chlorine  
 $50 \text{ ppm} \times 0.25 \text{ mg} \times 8.34 = 104.25 \text{ lbs of chlorine}$
- Change percent available to a decimal equivalent  
 $70\% = 0.70$
- Find lbs of HTH  
 $\frac{104.25 \text{ lbs Cl}}{0.70} = \mathbf{149 \text{ lbs of HTH}}$

A chlorine pump is feeding 10% bleach at a dosage of 5 mg/l. If 2,200,000 gallons are treated in 16 hours, how many gallons per hour is the pump feeding?

- Change gallons to mg  
 $2,200,000 \text{ gallons} = 2.2 \text{ mg}$
- Find lbs of chlorine  
 $5 \text{ ppm} \times 2.2 \text{ mg} \times 8.34 = 91.7 \text{ lbs of Chlorine}$
- Change percent available to a decimal equivalent  
 $10\% = 0.10$
- Find lbs of Bleach  
 $\frac{91.7 \text{ lbs Cl}}{0.10} = 917 \text{ lbs of Bleach}$
- Find gallons of Bleach  
 $\frac{917 \text{ lbs Bleach}}{8.34 \text{ lbs/gal}} = 110 \text{ gallons of Bleach}$

- Find gallons per hour  
 $\frac{110 \text{ gal.}}{16 \text{ hr}} = \mathbf{6.9 \text{ gal/hr}}$

A 12" pipe is 1880' long and must be disinfected with 50 ppm of 65% HTH. How many pounds of HTH are needed?

- Find the volume of the pipe in gallons  
 $12'' \times 12'' \times .0408 \times 1880' = 11,045 \text{ gallons}$
- Change gallons to mgd  
 $11,045 \text{ gallons} = 0.011 \text{ mgd}$
- Find lbs of chlorine  
 $50 \text{ ppm} \times 0.011 \text{ mgd} \times 8.34 = 4.6 \text{ lbs of Chlorine}$
- Change percent available to a decimal equivalent  
 $65\% = 0.65$
- Find lbs of HTH  
 $\frac{4.6 \text{ lbs Cl}}{0.65} = \mathbf{7.1 \text{ lbs of HTH}}$

Liquid chemical dosages can be calculated to determine the gallons per day. Chemical feed pumps are calibrated using ml/min. If you take 3785 ml/gal and divide it by 1440 min/day, the conversion for gal/day to ml/min can be determined.

$$\frac{3785 \text{ ml/gal}}{1440 \text{ min/day}} = 2.6 \text{ ml/min /gal/day}$$

$$\text{Gal/day} \times 2.6 = \text{ml/min}$$

**EXAMPLES:**

A 20% available Fluoride solution is used to dose 2,000,000 gpd at 450 ppb (parts per billion). How many ml/min is the pump feeding?

- Change 450 ppb to ppm  
 $450 \text{ ppb} = 0.45 \text{ ppm (mg/l)}$
- Change 2,000,000 gpd to mgd  
 $2,000,000 \text{ gpd} = 2.0 \text{ mgd}$
- Find lbs of Fluoride  
 $0.45 \text{ ppm} \times 2.0 \text{ mgd} \times 8.34 = 7.5 \text{ lbs/day}$
- Change percent available to a decimal equivalent  
 $20\% = 0.2$
- Find lbs of Fluoride solution  
 $\frac{7.5 \text{ lbs F}}{0.2} = 37.5 \text{ lbs of F solution}$
- Find gallons of fluoride  
 $\frac{37.5 \text{ lbs solution}}{8.34 \text{ lbs/gal}} = 4.5 \text{ gpd}$
- Change gallon/day to ml/min  
 $4.5 \text{ gpd} \times 2.6 = \mathbf{11.7 \text{ ml/min}}$



An 18% available Alum solution is used to dose 600,000 gpd at 25 mg/l. How many ml/min is the pump feeding?

- Change 600,000 gpd to mgd  
 $25 \text{ mg/l} \times 0.6 \text{ mgd} \times 8.34 = 125 \text{ lbs/day}$
- Change percent available to a decimal equivalent  
 $18\% = 0.18$
- Find lbs of Alum solution  
 $\frac{125 \text{ lbs Alum}}{0.18} = 695 \text{ lbs of Alum solution}$
- Find gallons of Alum  
 $\frac{695 \text{ lbs solution}}{8.34 \text{ lbs/gal}} = 83.3 \text{ gpd}$
- Change gallon/day to ml/min  
 $83.3 \text{ gpd} \times 2.6 = 217 \text{ ml/min}$

Sometimes there is too much information in the question. The example below has too much information. The well flow and storage tank data are not needed to work the problem.

**EXAMPLE:**

A system has a well that produces 200 gpm and a 1500 gallon storage tank. There are 120 homes on the systems and the average daily consumption is 350 gallons/home. A chlorine dosage of 1.3 ppm is maintained using 65% HTH. How many pounds of HTH must be purchased each year?

- Find system consumption  
 $120 \text{ homes} \times 350 \text{ gallons/day/home} = 42,000 \text{ gpd}$
- Change gallons/day to mgd  
 $42,000 \text{ gallons/day} = 0.042 \text{ mgd}$
- Find lbs/day of chlorine  
 $1.3 \text{ ppm} \times 0.042 \text{ mg} \times 8.34 = 0.45 \text{ lbs/day of Cl}$
- Change percent available to a decimal equivalent  
 $65\% = 0.65$
- Find lbs/day of HTH  
 $\frac{0.45 \text{ lbs Cl}}{0.65} = 0.7 \text{ lbs/day of HTH}$
- Find lbs/year of HTH  
 $0.7 \text{ lbs/day} \times 365 \text{ days/year} = 255.5 \text{ lbs/year}$

**WIRE-TO-WATER CALCULATIONS**

The term wire-to-water refers to the conversion of electrical horsepower to water horsepower. The motor takes electrical energy and converts it into mechanical energy. The pump turns mechanical energy into hydraulic energy. The electrical energy is measured as motor horsepower (MHP.) The mechanical energy is measured as brake horsepower (BHP.) And the hydraulic energy is measured as water horsepower (WHP.)

Horsepower is measured by lifting a weight a given distance in a specific time period. One horsepower is the amount of energy required to produce 33,000 ft-lbs of work per minute. That means that lifting 33,000 pounds one foot in one minute or lifting one pound 33,000 feet in the air in one minute would both require one horsepower worth of energy.

When water is pumped, performance is measured in flow (gallons/minute) and pressure (feet of head). If you multiply gallons per minute and feet of head the resulting units would be gallon-feet per minute. Multiply gallon-feet per minute by 8.34 pounds/gallon and the units become footpounds (of water) per minute. This can now be converted to water horsepower by dividing by 33,000 ft-lbs/min per horsepower.

$$\frac{\text{Gpm} \times 8.34 \times \text{Feet of Head}}{33,000 \text{ ft-lbs/min/Hp}} = \text{Water Horsepower (WHP)}$$

This equation can be further simplified to:

$$\frac{\text{Gpm} \times \text{Feet of Head}}{3960} = \text{Water Horsepower (WHP)}$$

Brake horsepower is the amount of energy that must go into the pump to produce the required WHP. Losses due to friction and heat in the pump reduce the pump's efficiency and require more energy in than goes out. If a pump is 80% efficient, it requires 10 BHP to generate 8 WHP.

$$\frac{\text{BrakeHp}}{\text{Pump Efficiency}} = \text{WaterHp}$$

Motor horsepower is the amount of electrical energy that must go into the motor to produce the required BHP. Losses due to friction and heat in the motor reduce the motor's efficiency and require more energy in than goes out. If a motor is 88% efficient, it requires 10 BHP to generate 8.8 BHP.

$$\frac{\text{MotorHp}}{\text{Motor Eff}} = \text{BrakeHp}$$

or

$$\frac{\text{MotorHp}}{\text{Motor Eff} \times \text{Pump Eff}} = \text{WaterHp}$$

Motor horsepower can be converted into kilowatts by multiplying by 0.746 Kw/Hp. Kilowatt-hours can be determined by multiplying kilowatts by run time in hours.

$$\text{MotorHp} \times 0.746 \text{ Kw/Hp} \times \text{Hours} = \text{Kw-Hours of electricity}$$

The following example has seven problems that relate to wire-to-water calculations. Each problem will take the calculation one step further. It is intended to show how the steps are linked, not to represent an example of a set of exam questions. An actual exam question would possibly require the calculation of Water horsepower (Problems 1-3) or calculation of cost of operation (Problems 1-7).

### Pump Data:

- 6 Feet - Negative Suction Head
- 96 Feet - Discharge Head
- 17 Feet - Friction Loss
- 400 gpm - Flow
- Motor Efficiency - 90%
- Pump Efficiency - 80%

What is the static head on the pump?

$$96 \text{ ft} + 6 \text{ ft} = \mathbf{102 \text{ ft}}$$

What is the total dynamic head?

$$96 \text{ ft} + 6 \text{ ft} + 17 \text{ ft} = \mathbf{119 \text{ ft TDH}}$$

What is the Water Horsepower that the pump delivers?

$$\frac{400 \text{ gpm} \times 119 \text{ ft}}{3960} = \mathbf{12 \text{ WHp}}$$

What is the Brake Horsepower?

- Change 80% to a decimal

$$80\% = 0.80$$

- Find Brake Horsepower

$$\frac{12 \text{ Whp}}{0.80 \text{ Pump Eff}} = \mathbf{15 \text{ BHp}}$$

What is the Motor Horsepower?

- Change 90% to a decimal

$$90\% = 0.90$$

- Find Motor Horsepower

$$\frac{15 \text{ BHp}}{0.90 \text{ Motor Eff}} = \mathbf{16.7 \text{ MHp}}$$

How many Kilowatts of electricity does the motor require?

$$6.7 \text{ MHp} \times 0.746 \text{ Kw/HP} = \mathbf{12.5 \text{ Kw}}$$

If the pump runs 13 hours a day and electric rates are \$0.09/Kw-Hour; How much does it cost to run the pump for a month (30 days)?

- Find Kw-Hours per day

$$12.5 \text{ Kw} \times 13 \text{ hours/day} = 162 \text{ Kw-Hours/day}$$

- Find cost per day

$$162 \text{ Kw-Hours} \times \$0.09/\text{KwHour} = \$14.58/\text{day}$$

- Find cost for the month

$$14.58/\text{day} \times 30 \text{ days/month} = \mathbf{\$437.40/month}$$

---

### References

Office of Water Programs, California State University, Sacramento, *Water Treatment Plant Operation*, 4<sup>th</sup> ed., 1999, Vol. 1-2, Appendix

Office of Water Programs, California State University, Sacramento, *Small Water Systems O&M*, 4<sup>th</sup> ed., 2001, Appendix

Office of Water Programs, California State University, Sacramento, *Water Distribution Systems O&M*, 4<sup>th</sup> ed., 2000, Appendix

---

### BASIC SAMPLE PROBLEMS

1. A pressure gauge reading is 80 psi. How many feet of head is this?  
A. 173 feet  
B. 185 feet  
C. 200 feet  
D. 212 Feet
2. The pump is 150 feet below the reservoir level. What is the pressure reading on the gauge in psi?  
A. 52 psi  
B. 60 psi  
C. 65 psi  
D. 75 psi
3. A tank is 20' x 60' by 15' deep. What is the volume in gallons?  
A. 115,000 gallons  
B. 128,000 gallons  
C. 135,000 gallons  
D. 154,000 gallons
4. A tank is 60' in diameter and 22' high. How many gallons will it hold?  
A. 465,000 gallons  
B. 528,000 gallons  
C. 640,000 gallons  
D. 710,000 gallons
5. A dosage of 2.4 mg/l of chlorine gas is added to 3.8 mgd. How many pounds per day of chlorine are needed?  
A. 68 lbs/day  
B. 76 lbs/day  
C. 82 lbs/day  
D. 88 lbs/day
6. How many gallons are in a 6" pipe 950 feet long?  
A. 1108 gallons  
B. 1253 gallons  
C. 1308 gallons  
D. 1395 gallons
7. A 12" pipe is carrying water at a velocity of 5.8 fps.

What is the flow?

- A. 4.55 cfs
- B. 5.36 cfs
- C. 5.67 cfs
- D. 6.04 cfs

18 Feet - Positive Suction Head

158 Feet - Discharge Head

26 Feet - Friction Loss

1200 gpm - Flow

Motor Efficiency - 86%

Pump Efficiency - 78%

### ADVANCED SAMPLE PROBLEMS

1. The pressure at the top of the hill is 62 psi. The pressure at the bottom of the hill, 60 feet below, is 100 psi. The water is flowing uphill at 120 gpm. What is the friction loss, in feet, in the pipe?

- A. 24.6 feet
- B. 27.8 feet
- C. 31.2 feet
- D. 33.8 feet

2. A tank is 82' in diameter and 31 feet high. The flow is 1600 gpm. What is the detention time in hours?

- A. 12.75 hours
- B. 14.80 hours
- C. 16.00 hours
- D. 18.25 hours

3. A tank is 120' x 50' x 14' deep. The flow is 2.8 mgd. What is the detention time in hours?

- A. 3.8 hours
- B. 4.4 hours
- C. 5.3 hours
- D. 6.2 hours

4. A 16" pipe is 1250 feet long. How much 65% HTH is needed to dose it with 50 mg/l of chlorine?

- A. 6.50 lbs
- B. 7.25 lbs
- C. 7.96 lbs
- D. 8.34 lbs

5. A solution of hydrofluosilicic acid is 22% fluoride. If 750 ppb are added to 5,600,000 gallons/day, how many ml/min should the pump be feeding?

- A. 26 ml/min
- B. 35 ml/min
- C. 42 ml/min
- D. 50 ml/min

6. A bleach system feeds 12% bleach. The dosage is 1.4 mg/l for 8.2 mgd. How many ml/min should the pump feed?

- A. 200 ml/min
- B. 250 ml/min
- C. 300 ml/min
- D. 350 ml/min

7. **Pump Data:**

What is the motor horsepower?

- A. 60 MHP
- B. 65 MHP
- C. 70 MHP
- D. 75 MHP

8. **Pump Data:**

20 Feet - Positive Suction Head

185 Feet - Discharge Head

18 Feet - Friction Loss

300 gpm - Flow

Motor Efficiency - 90%

Pump Efficiency - 80%

Kw-Hour Cost = \$0.11/Kw-Hr

Average Run Time – 6 Hours/day

What is the cost to run the pump for 30 days?

- A. \$245.08
- B. \$284.34
- C. \$410.50
- D. \$463.82

BLANK PAGE



# Response Protocol Toolbox: Planning for and Responding to Drinking Water Contamination Threats and Incidents

Interim Final - December 2003

## Module 1: Water Utilities Planning Guide



# Response Protocol Toolbox: Planning for and Responding to Drinking Water Contamination Threats and Incidents

## Module 1: Water Utilities Planning Guide

Interim Final - December 2003

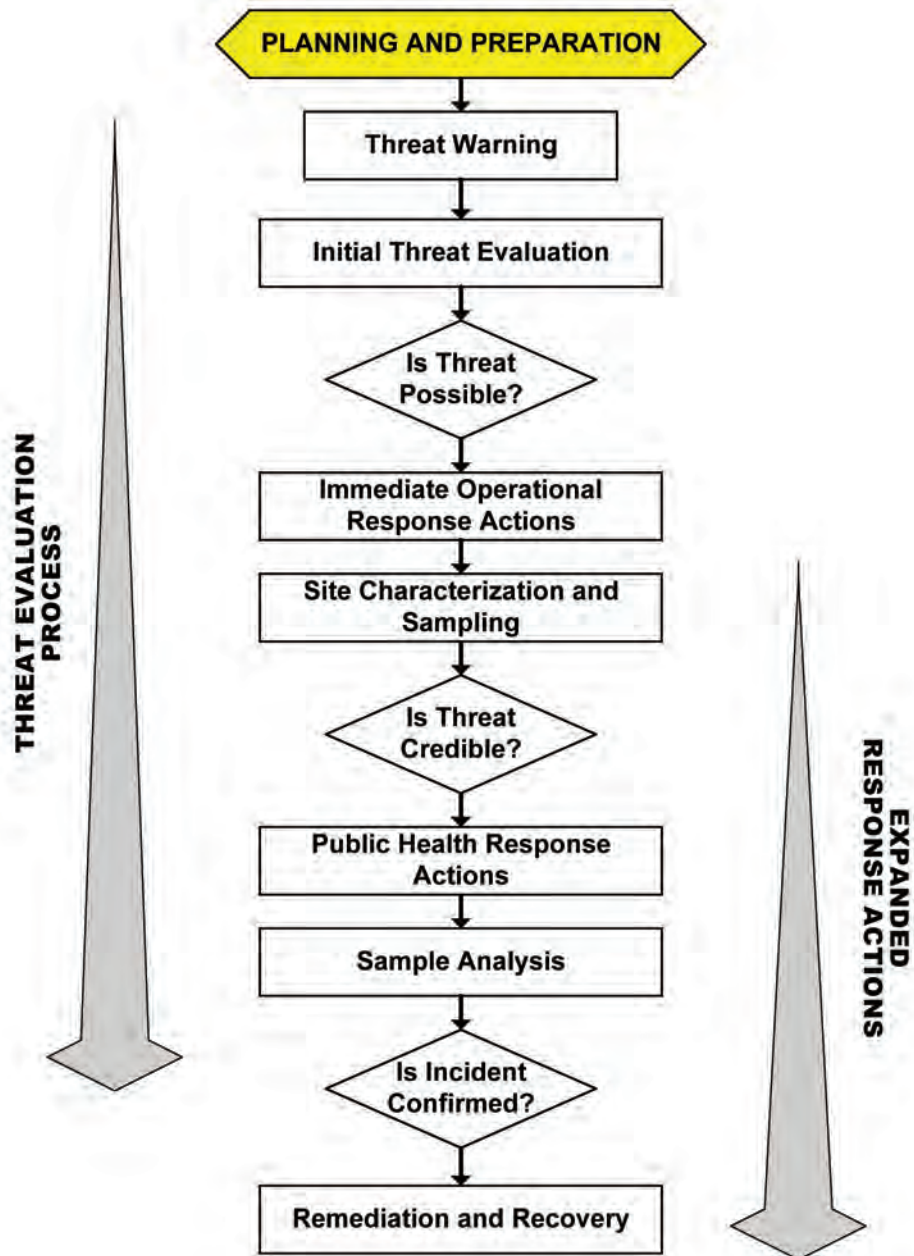

## OTHER RESPONSE PROTOCOL TOOLBOX MODULES

### **Module 1: Water Utility Planning Guide** (*December 2003*)

Module 1 provides a brief discussion of the nature of the contamination threat to the public water supply. The module also describes the planning activities that a utility may undertake to prepare for response to contamination threats and incidents.

### **Module 2: Contamination Threat Management Guide** (*December 2003*)

Module 2 presents the overarching framework for management of contamination threats to the drinking water supply. The threat management process involves two parallel and interrelated activities: 1) evaluating the threat, and 2) making decisions regarding appropriate actions to take in response to the threat.

### **Module 3: Site Characterization and Sampling Guide** (*December 2003*)

Module 3 describes the site characterization process in which information is gathered from the site of a suspected contamination incident at a drinking water system. Site characterization activities include the site investigation, field safety screening, rapid field testing of the water, and sample collection.

### **Module 4: Analytical Guide** (*December 2003*)

Module 4 presents an approach to the analysis of samples collected from the site of a suspected contamination incident. The purpose of the Analytical Guide is **not** to provide a detailed protocol. Rather, it describes a framework for developing an approach for the analysis of water samples that may contain an unknown contaminant. The framework is flexible and will allow the approach to be crafted based on the requirements of the specific situation. The framework is also designed to promote the effective and defensible performance of laboratory analysis.

### **Module 5: Public Health Response Guide** (*available March 2004*)

Module 5 deals with the public health response measures that would potentially be used to minimize public exposure to potentially contaminated water. It discusses the important issue of who is responsible for making the decision to initiate public health response actions, and considers the role of the water utility in this decision process. Specifically, it examines the role of the utility during a public health response action, as well as the interactions among the utility, the drinking water primacy agency, the public health community, and other parties with a public health mission.

### **Module 6: Remediation and Recovery Guide** (*available March 2004*)

Module 6 describes the planning and implementation of remediation and recovery activities that would be necessary following a confirmed contamination incident. The remediation process involves a sequence of activities, including: system characterization; selection of remedy options; provision of an alternate drinking water supply during remediation activities; and monitoring to demonstrate that the system has been remediated. Module 6 describes the types of organizations that would likely be involved in this stage of a response, and the utility's role during remediation and recovery.

**TABLE OF CONTENTS**

**1 INTRODUCTION: WHY SHOULD I READ THIS MODULE?.....11**

**2 WHAT ARE CONTAMINATION THREATS AND INCIDENTS? .....12**

2.1 OVERVIEW OF CONTAMINATION THREATS AND INCIDENTS.....12

2.2 WARNINGS SIGNS OF A CONTAMINATION THREAT.....16

**3 HOW SHOULD I RESPOND TO WATER CONTAMINATION THREATS? .....19**

3.1 I'M JUST A UTILITY—WHY DO I NEED TO DO ANYTHING AT ALL?.....19

3.2 DUE DILIGENCE—WHEN HAVE I DONE ENOUGH?.....19

**4 WHAT CAN I DO TO PREPARE? .....22**

4.1 KNOW YOUR WATER SYSTEM.....22

4.1.1 CONSTRUCTION AND OPERATION.....22

4.1.2 PERSONNEL .....23

4.1.3 CUSTOMERS.....23

4.2 UPDATE EMERGENCY RESPONSE PLANS FOR INTENTIONAL CONTAMINATION .....24

4.3 DEVELOP RESPONSE GUIDELINES FOR INTENTIONAL CONTAMINATION .....24

4.4 ESTABLISH STRUCTURE FOR INCIDENT COMMAND.....24

4.5 DEVELOP INFORMATION MANAGEMENT STRATEGY .....29

4.6 ESTABLISH COMMUNICATION AND NOTIFICATION STRATEGY.....30

4.7 PERFORM TRAINING AND DESK/FIELD EXERCISES.....33

4.8 ENHANCE PHYSICAL SECURITY .....34

4.9 ESTABLISH BASELINE MONITORING PROGRAM .....34

4.10 UTILIZE AND UNDERSTAND ON-LINE MONITORING.....35

**5 REFERENCES AND RESOURCES.....36**

**6 APPENDICES .....38**

6.1 SAMPLE OUTLINE OF RESPONSE GUIDELINE.....38

6.2 U.S. GOVERNMENT RESPONSE PLANS.....39

6.2.1 NATIONAL RESPONSE PLAN.....39

6.2.2 FEDERAL RESPONSE PLAN .....39

6.3 ON-LINE MONITORING SYSTEMS .....43

6.3.1 CONVENTIONAL SYSTEMS .....43

6.3.2 EARLY WARNING SYSTEMS .....43

**LIST OF TABLES**

TABLE 1-1: CONTAMINANT CLASSES, THEIR AVAILABILITIES, AND RESTRICTIONS..... 14

TABLE 1-2: PRIORITIZATION CRITERIA FOR POTENTIAL WATER CONTAMINANTS..... 16

**LIST OF FIGURES**

FIGURE 1-1: SUMMARY OF THREAT WARNINGS..... 17

FIGURE 1-2: OVERVIEW OF RESPONSE TO A CONTAMINATION THREAT..... 21

FIGURE 1-3: EXPANSION OF, AND CHANGES TO, INCIDENT COMMAND STRUCTURE FOR THE THREE THREAT EVALUATION STAGES..... 27

FIGURE 1-4: SAMPLE COMMUNICATION SCHEMES FOR THE THREE THREAT EVALUATION STAGES.....31

FIGURE 1-5: OVERVIEW OF POTENTIAL EXTERNAL NOTIFICATIONS .....32



**ACRONYMS**

AWWARF	American Water Works Association Research Foundation
C/B	Chemical/Biological
CD	Compact disk
CDC	Centers for Disease Control and Prevention
DBP	Disinfection by-product
DHS	Department of Homeland Security
DOC	Department of Commerce
DOD	Department of Defense
DOE	Department of Energy
DOI	Department of the Interior
DOJ	Department of Justice
DOL	Department of Labor
DOS	Department of State
DOT	Department of Transportation
EPA	U.S. Environmental Protection Agency
ERP	Emergency response plans
ESF	Emergency support function
EWS	Early warning system
FBI	Federal Bureau of Investigation
FCO	Federal coordinating officer
FEMA	Federal Emergency Management Agency
FRP	Federal Response Plan
GIS	Geographic information system
GSA	Government services agency
HazMat	Hazardous materials
HHS	Department of Health and Human Services
IC	Incident commander
ICS	Incident Command System
ILSI	International Life Sciences Institute Risk Science Institute
IO	Information officer
JIC	Joint information center
JOC	Joint operations center
LFA	Lead federal agency
LO	Liaison officer
LPoC	Laboratory point of contact
LRN	Laboratory Response Network
NCP	National Oil and Hazardous Substances Pollution Contingency Plan
NIIMS	National Interagency Incident Management System
NIMS	National Incident Management System
NRC	Nuclear Regulatory Commission
NRP	National Response Plan
OSC	On-scene coordinator
PDD	Presidential decision directive
RG	Response guideline

RPTB	Response Protocol Toolbox
RST	Regional support team
SCADA	Supervisory control and data acquisition
SDWA	Safe Drinking Water Act
TOC	Total organic carbon
URL	Uniform resource locator
USACE	United States Army Corps of Engineers
USCG	United States Coast Guard
USDA	United States Department of Agriculture
UV	Ultraviolet
WCIT	Water contaminant information tool
WHO	World Health Organization
WUERM	Water utility emergency response manager
WUOCM	Water utility emergency operations center manager

## GLOSSARY

Definitions in this glossary are specific to the Response Protocol Tool Box but conform to common usage as much as possible.

**Agency** – a division of government with a specific function, or a non-governmental organization (e.g., private contractor, business, etc.) that offers a particular kind of assistance. In the incident command system, agencies are defined as jurisdictional (having statutory responsibility for incident mitigation) or assisting and/or cooperating (providing resources and/or assistance).

**Agency Representative** – an individual assigned to an incident from an assisting or cooperating agency who has been delegated authority to make decisions on matters affecting that agency's participation at the incident.

**Assisting Agency** – an agency directly contributing tactical or service resources to another agency.

**Bioterrorism Act** – the Public Health Security and Bioterrorism Preparedness and Response Act of 2002.

**Chain of Command** – a series of management positions in order of authority.

**'Confirmatory' Stage** – the third stage of the threat evaluation process from the point at which the threat is deemed 'credible' through the determination that a *contamination incident* either has or has not occurred.

**'Confirmed'** – in the context of the *threat evaluation* process, a water contamination incident is 'confirmed' if the information collected over the course of the threat evaluation provides definitive evidence that the water has been contaminated.

**Contamination Site** – the location where a contaminant is known or suspected to have been introduced into a drinking water system. For example, a distribution system storage tank where a security breach has occurred may be designated as a suspected contamination site. The contamination site will likely be designated as an *investigation site* for the purpose of *site characterization*.

**Cooperating Agency** – an agency supplying assistance, other than direct tactical or support functions, or resources to the incident control effort (e.g., Red Cross, telephone companies).

**Coordination** – the process of systematically analyzing a situation, developing relevant information, and informing the appropriate command authority of viable alternatives for selection of the most effective combination of available resources to meet specific objectives. The coordination process (which can be either intra- or inter-agency) does not involve dispatch actions. However, personnel responsible for coordination may perform command or dispatch functions within the limits established by specific agency delegations, procedures, legal authority, etc.

**‘Credible’** – in the context of the *threat evaluation* process, a water contamination threat is characterized as ‘credible’ if information collected during the threat evaluation process corroborates information from the *threat warning*.

**‘Credible’ Stage** – the second stage of the threat management process from the point at which the threat is deemed ‘possible’ through the determination as to whether or not the threat is ‘credible’.

**Drinking Water Primacy Agency** – the *agency* that has primary enforcement responsibility for national drinking water regulations, namely, the Safe Drinking Water Act as amended. Drinking water primacy for a particular state may reside in one of a variety of agencies, such as health departments, environmental quality departments, etc. The drinking water primacy agency is typically the State Health Agency or the State Environmental Agency. The drinking water primacy agency may also play the role of *technical assistance provider* to drinking water utilities.

**Emergency Operations Center** – a pre-designated facility established by an agency or jurisdiction to coordinate the overall agency or jurisdictional response and support to an emergency.

**Emergency Response Plan** – a document that describes the actions that a drinking water utility would take in response to various emergencies, disasters, and other unexpected incidents.

**Event** – a planned, non-emergency activity (e.g., parades, concerts, sporting events, etc.).

**Immediate Operational Response** – an action taken in response to a ‘possible’ contamination threat in an attempt to minimize the potential for exposure to the potentially contaminated water. Immediate operational response actions will generally have a negligible impact on consumers.

**Incident** – a confirmed occurrence that requires response actions to prevent or minimize loss of life or damage to property and/or natural resources. A drinking water contamination incident occurs when the presence of a harmful contaminant has been confirmed.

**Incident Command System** – a standardized on-scene emergency management concept specifically designed to allow its user(s) to adopt an integrated organizational structure appropriate for the complexity and demands of single or multiple incidents, without being hindered by jurisdictional boundaries.

**Incident Commander** – the individual responsible for the management of all incident operations.

**Incident Objectives** – statements of guidance and direction necessary for the selection of appropriate strategy(ies), and the tactical direction of resources. Incident objectives are based on realistic expectations of what can be accomplished when all allocated resources have been

effectively deployed. Incident objectives must be achievable and measurable, yet flexible enough to allow for strategic and tactical alternatives.

**Information Officer** – the individual responsible for interfacing with the public and media or with other agencies requiring information directly from the incident. Under the ICS, there is only **one** Information Officer per incident.

**Investigation Site** – the location where site characterization activities are performed. If a suspected *contamination site* has been identified, it will likely be designated as a primary investigation site. Additional or secondary investigation sites may also be identified due to the potential spread of a contaminant.

**Jurisdiction** – the range or sphere of authority. Public agencies have jurisdiction at an incident related to their legal responsibilities and authority for incident mitigation. Jurisdictional authority at an incident can be political/geographic (e.g., city, county, State, or Federal boundary lines) or functional (e.g., police department, health department, etc.).

**Multi-jurisdiction Incident** – an incident requiring action from multiple agencies that have a statutory responsibility for incident mitigation. In ICS, these incidents will be managed under Unified Command.

**National Interagency Incident Management System** – a program developed by the National Wildfire Coordinating Group consisting of five major subsystems which collectively provide a total systems approach to all-risk incident management. The subsystems are the Incident Command System, Training, Qualifications and Certification, Supporting Technologies, and Publications Management.

**Notification** – the process of communication information to interested parties.

**Opportunity Contaminant** – contaminants that might be readily available in a particular area, even though they may not be highly toxic or infectious or easily dispersed and stable in treated drinking water.

**‘Possible’** – in the context of the *threat evaluation* process, a water contamination threat is characterized as ‘possible’ if the circumstances of the *threat warning* appear to have provided an opportunity for contamination.

**‘Possible’ Stage** – the first stage of the threat management process from the point at which the *threat warning* is received through the determination as to whether or not the threat is ‘possible.’

**Quality Assurance** – an integrated system of management activities involving planning, implementation, documentation, assessment, reporting, and quality improvement, to ensure that a process, item, or service is of the type and quality needed and expected by the client.

**Quality Control** – the overall system of technical activities that measures the attributes and performance of a process, item, or service against defined standards to verify that they meet the

stated requirements established by the client; operational techniques and activities that are used to fulfill requirements for quality.

**Response Guidelines** – a manual designed to be used **during** the response to a water contamination threat. Response Guidelines should be easy to use and contain forms, flow charts, and simple instructions to support staff in the field or decision officials in the *Emergency Operations Center* during management of a crisis.

**Secure Area** – a locked space, such as a cabinet or vault, with access restricted to authorized personnel.

**Site Characterization** – the process of collecting information from an *investigation site* in order to support the evaluation of a drinking water contamination threat. Site characterization activities include the site investigation, *field safety screening*, *rapid field testing* of the water, and sample collection.

**Technical Assistance Provider** – any organization or individual that provides assistance to drinking water utilities in meeting their mission to provide an adequate and safe supply of water to their customers. The *drinking water primacy agency* may serve as a technical assistance provider.

**Threat** – an indication that a harmful *incident*, such as contamination of the drinking water supply, may have occurred. The threat may be direct, such as a verbal or written threat, or circumstantial, such as a security breach or unusual water quality.

**Threat Evaluation** – part of the threat management process in which all available and relevant information about the threat is evaluated to determine if the threat is ‘possible’ or ‘credible’, or if a contamination *incident* has been ‘confirmed.’ This is an iterative process in which the threat evaluation is revised as additional information becomes available. The conclusions from the threat evaluation are considered when making *response decisions*.

**Threat Management** – the process of evaluating a contamination threat and making decisions about appropriate response actions. The threat management process includes the parallel activities of the *threat evaluation* and making *response decisions*. The threat management process is considered in three stages: ‘possible’, ‘credible’, and ‘confirmatory.’ The severity of the threat and the magnitude of the response decisions escalate as a threat progresses through these stages.

**Threat Warning** – an unusual occurrence, observation, or discovery that indicates a potential contamination incident and initiates actions to address this concern.

**Unified Command** – a unified team effort which allows all agencies with responsibility for the incident, either geographic or functional, to manage an incident by establishing a common set of incident objectives and strategies. This is accomplished without losing or abdicating agency authority, responsibility, or accountability.

**Unity of Command** – the concept by which each person within an organization reports to only one designated person.

**Vulnerability Assessment** – a systematic process for evaluating the susceptibility of critical facilities to potential threats and identifying corrective actions that can reduce or mitigate the risk of serious consequences associated with these threats.

**Water Contamination Incident** – a situation in which a contaminant has been successfully introduced into the system. A water contamination incident may or may not be preceded by a water contamination threat

**Water Contamination Threat** – a situation in which the introduction of a contaminant into the water system is threatened, claimed, or suggested by evidence. Compare *water contamination threat* with *water contamination incident*. Note that threatening a water system may be a crime under the Safe Drinking Water Act as amended by the Bioterrorism Act.

**Water Utility Emergency Operations Center Manager** – the individual responsible for carrying out the plan for emergency operations at the water utility during an emergency incident.

**Water Utility Emergency Response Manager (WUERM)** – the individual(s) within the drinking water utility management structure that has the responsibility and authority for managing certain aspects of the utility's response to an emergency (e.g., a contamination threat) particularly during the initial stages of the response. The responsibilities and authority of the WUERM are defined by utility management and will likely vary based on the circumstances of a specific utility.

## 1 Introduction: Why Should I Read this Module?

The primary audience for this module is drinking water utilities, which need to **plan** for and **practice** managing and responding to contamination attacks. However, there are many other groups that may be involved in responding to water contamination *threats* and *incidents*, and they also may benefit from reviewing this module to assist in their **planning** activities. These groups include analytical laboratories, emergency responders, state *drinking water primacy agencies*, *technical assistance providers*, public health officials, federal agencies (including EPA), and law enforcement agencies, among others. The objectives of this module are:

- To familiarize the reader with the nature and warning signs of water contamination threats and incidents. The reader will learn that drinking water contamination incidents are possible and that contamination threats are probable.
- To describe the overall framework for responding to a range of contamination threats, ranging from hoaxes to confirmed contamination incidents. This framework, the primary focus of the Response Protocol Toolbox (RPTB), is one of the highest water security priorities identified by the water sector and the EPA.
- To help readers prepare for responding to contamination threats through: 1) Careful planning; 2) Development of *Response Guidelines*; 3) Establishing *notification* procedures and internal *chain of command*; and 4) Performing training exercises.

This module is organized into five sections as described below.

- Section 1: Introduction: describes the objectives and overall organization of this module.
- Section 2: What are Contamination Threats and Incidents? Provides background information on the contamination threat to water systems, including a discussion of potential warning signs of contamination.
- Section 3: How Should I Respond to Water Contamination Threats? Discusses the need for response and introduces the concept of 'due diligence' in responding to contamination threats.
- Section 4: What Can I do to Prepare? Highlights several areas in which utilities can enhance their preparedness for contamination threats.
- Section 5: References and Resources: Lists the references used in the development of this module as well as additional information resources.
- Section 6: Appendices: Provides a sample outline for utility Response Guidelines, describes the roles of federal agencies under two U.S. government response plans, and provides an overview of drinking water security applications for on-line monitoring systems.



## 2 What are Contamination Threats and Incidents?

### 2.1 Overview of Contamination Threats and Incidents

Both *water contamination threats* and *water contamination incidents* could be designed to interrupt the delivery of safe water to a population, interrupt fire protection, create public panic, or cause disease or death in a population. A water contamination threat occurs when the introduction of a contaminant into the water system is threatened, claimed, or suggested by evidence. A water contamination incident occurs when a contaminant is successfully introduced into the water supply. The water contamination incident may be preceded by a threat, but not always. Both water contamination threats and incidents may be of particular concern due to the range of potential consequences:

- Creating an adverse impact on public health within a population.
- Disrupting system operations and interrupting the supply of safe water.
- Causing physical damage to system infrastructure.
- Reducing public confidence in the water supply.
- Long-term denial of water and the cost of remediation and replacement.

Some of these consequences would only be realized in the event of a successful contamination incident; however, the mere threat of contamination can have an adverse impact on a water system if improperly handled.

In characterizing any threat, both the **possibility** and **probability** should be considered. A general assessment of the threat of intentional contamination of drinking water indicates that it is **possible** to cause varying degrees of harm by contaminating a water system. Specifically, this assessment indicates that:

- Only a few contaminants have the potential to produce widespread death or disease in a population. These contaminants include concentrated pathogens, biotoxins, and a few highly toxic chemicals that may remain stable in water long enough to adversely impact public health.
- A larger group of contaminants could produce localized death or disease in a segment of a population, including several dozen toxic chemicals.
- Hundreds of contaminants could potentially disrupt service or undermine consumer confidence but would not result in death or disease in the population.

While it is important to consider the range of possibilities associated with a particular threat, assessments are typically based on the **probability** of a particular occurrence. Determining probability is somewhat subjective, and is often based on intelligence and previous incidents. There are historical accounts of intentional contamination of drinking water supplies with biological or chemical contaminants, but most have been associated with wartime activities ([http://www.who.int/emc/pdfs/BIOWEAPONS\\_FULL\\_TEXT2.pdf](http://www.who.int/emc/pdfs/BIOWEAPONS_FULL_TEXT2.pdf)). The few documented accounts of intentional contamination of public water systems in the U.S. have not resulted in any reported fatalities. The American Water Works Association Research Foundation (AWWARF) is preparing a report on this subject (AWWARF, 2003). Based on these accounts, it would appear that the probability of a successful contamination incident on a drinking water system is relatively low. However, there has been a reported increase in the interest of various terrorist groups in biological and chemical weapons. Furthermore, some

intelligence information indicates that terrorist organizations have considered water infrastructure as a possible target. Thus, the potential for such an incident does exist.

While the probability of an actual contamination incident may be considered low relative to other modes of attack, the probability of the **threat** of contamination may be relatively high compared to other forms of attack. Many of the apparent security breaches at drinking water utilities that have occurred since 9/11 have been perceived as potential contamination incidents. Although a few threats have been verbal, most have been circumstantial, such as a low-flying airplane over a reservoir or a lock cut from the hatch of a distribution system storage tank. Given the possibility of contamination, many utilities chose to treat these security breaches as potential contamination threats. These incidents demonstrate the need for a protocol to guide an appropriate response to contamination threats.

In order to prepare for contamination threats, there is a general sense that it is necessary to generate a list of priority contaminants. However, the generation of such a list is a significant challenge due to the wide range of adverse effects that might result from intentional contamination, as discussed at the beginning of this section. Furthermore, no list of contamination threats should be considered definitive or complete. A document prepared under the auspices of the World Health Organization succinctly sums up this dilemma, and places it in the context of planning for a response to a biological or chemical contamination incident:

“A central consideration in such preparedness planning is that it is neither possible nor necessary to specifically plan for attack by all possible biological and chemical agents. If a country is seeking to increase its preparedness to counter the effects of biological and chemical attacks, the targeting of its preparation and training on a limited but well chosen group of agents will provide the necessary capability to deal with a far wider range of possibilities. Knowledge of the general properties of this representative group of agents will enable certain measures to be taken against virtually any other agent. In addition to being impractical from a preparedness perspective, long and exhaustive lists of agents also give a misleading impression of the extent of possible threats.”

In: *Public health response to biological and chemical weapons: WHO guidance, 2nd edition* (Draft, March 2003), (<http://www.who.int/csr/delibepidemics/biochemguide/en/index.html>)

Nonetheless, many federal and private organizations have generated contaminant lists that reflect the specific priorities and assumptions of that organization. For instance, the military is largely concerned with safeguarding the readiness of our combat troops and hence focuses on the classical weapons of chemical and biological warfare, while other organizations are more focused on infectious diseases. While it is possible to use the experience gained from the preparation of these lists, it is very important to consider the special needs and challenges presented by safeguarding public health through protection of the drinking water supply. For instance, there is essentially no tolerance by the public toward sudden disease and death from tainted water supplies. Another challenge is that drinking water is used not only for consumption but also for other uses such as fire protection, sanitation, and industrial processes. In fact, most treated drinking water is used for purposes other than consumption.

Table 1-1 presents a number of contaminant classes that would potentially have an adverse impact if introduced into the drinking water supply. This is not intended to be an exhaustive list, and there may be many others that may be used to contaminate a water supply.

**Table 1-1 Contaminant Classes, their Availabilities, and Restrictions**

Class	Examples (not exhaustive)	Sources	Limited access?
<b>MICROBIOLOGICAL CONTAMINANTS</b>			
Bacteria	<i>Bacillus anthracis</i> , <i>Brucella</i> spp., <i>Burkholderia</i> spp., <i>Campylobacter</i> spp., <i>Clostridium perfringens</i> , <i>E. coli</i> O157:H7, <i>Francisella tularensis</i> , <i>Salmonella typhi</i> , <i>Shigella</i> spp., <i>Vibrio cholerae</i> , <i>Yersinia pestis</i> , <i>Yersinia enterocolitica</i>	Naturally occurring, Microbiological laboratories <sup>1</sup> , state-sponsored programs	Yes for Select Agents
Viruses	Caliciviruses, Enteroviruses, Hepatitis A/E, Variola, VEE virus	Naturally occurring, Microbiological laboratories <sup>1</sup> , state-sponsored programs	Yes for Select Agents
Parasites	<i>Cryptosporidium parvum</i> , <i>Entamoeba histolytica</i> , <i>Toxoplasma gondii</i>	Naturally occurring, Microbiological laboratories <sup>1</sup>	No
<b>CHEMICAL CONTAMINANTS - Inorganic</b>			
Corrosives and caustics	Toilet bowl cleaners (hydrochloric acid), tree-root dissolver (sulfuric acid), drain cleaner (sodium hydroxide)	Retail, industry	No
Cyanide salts or cyanogenics	Sodium cyanide, potassium cyanide, amygdalin, cyanogen chloride, ferricyanide salts	Supplier, industry (esp. electroplating)	Yes
Metals	Mercury, lead, osmium, their salts, organic compounds, and complexes (even those of iron, cobalt, copper are toxic at high doses)	Industry, supplier, laboratory	Yes <sup>2</sup>
Nonmetal oxyanions, organo-nonmetals	Arsenate, arsenite, selenite salts, organoarsenic, organoselenium compounds	Some retail, industry, supplier, laboratory	Yes <sup>3</sup>
<b>CHEMICAL CONTAMINANTS - Organic</b>			
Fluorinated organics	Sodium trifluoroacetate (a rat poison), fluoroalcohols, fluorinated surfactants	Supplier, industry, laboratory	Yes
Hydrocarbons and their oxygenated and/or halogenated derivatives	Paint thinners, gasoline, kerosene, ketones (e.g., methyl isobutyl ketone), alcohols (e.g., methanol), ethers (e.g., methyl <i>tert</i> -butyl ether or MTBE), halohydrocarbons (e.g., dichloromethane, tetrachloroethene)	Retail, industry, laboratory, supplier	No
Insecticides	Organophosphates (e.g., Malathion), chlorinated organics (e.g., DDT), carbamates (e.g., Aldicarb) some alkaloids (e.g., nicotine)	Retail, industry, supplier (varies with compound)	Yes
Malodorous, noxious, foul-tasting, and/or lachrymatory chemicals <sup>4</sup>	Thiols (e.g., mercaptoacetic acid, mercaptoethanol), amines (e.g., cadaverine, putrescine), inorganic esters (e.g., trimethylphosphite, dimethylsulfate, acrolein)	Laboratory, supplier, police supply, military depot	Yes
Organics, Water-miscible	Acetone, methanol, ethylene glycol (antifreeze), phenols, detergents	Retail, industry, supplier, laboratory	No

## MODULE 1: Water Utility Planning Guide

Class	Examples (not exhaustive)	Sources	Limited access?
Pesticides other than insecticides	Herbicides (e.g., chlorophenoxy or atrazine derivatives), rodenticides (e.g., superwarfarins, zinc phosphide, $\alpha$ -naphthyl thiourea)	Retail, industry, agriculture, laboratory	Yes
Pharmaceuticals	cardiac glycosides, some alkaloids (e.g., vincristine), antineoplastic chemotherapies (e.g., aminopterin), anticoagulants (e.g., warfarin). Includes illicit drugs such as LSD, PCP, and heroin.	Laboratory, supplier, pharmacy, some from a natural source	Yes
<b>SCHEDULE 1 CHEMICAL WARFARE AGENTS</b>			
Schedule 1 Chemical Weapons	organophosphate nerve agents (e.g., sarin, tabun, VX), vesicants, [nitrogen and sulfur mustards (chlorinated alkyl amines and thioethers, respectively)], Lewisite	Suppliers, military depots, some laboratories	Yes
<b>BIOTOXINS</b>			
Biologically produced toxins	Biotoxins from bacteria, plants, fungi, protists, defensive poisons in some marine or terrestrial animals. Examples include ricin, saxitoxin, botulinum toxins, T-2 mycotoxins, microcystins.	Laboratory, supplier, pharmacy, natural source <sup>5</sup> , state-sponsored programs	Yes
<b>RADIOLOGICAL CONTAMINANTS</b>			
Radionuclides	Does not refer to nuclear, thermonuclear, or neutron bombs. Radionuclides may be used in medical devices and industrial irradiators (Cesium-137 Iridium-192, Cobalt-60, Strontium-90). Class includes both the metals and salts.	Laboratory, state sources, waste facilities	Yes <sup>2</sup>

1. The quantity of bacteria, viruses, or parasites needed for widespread contamination of a water system is not available in a typical clinical laboratory, although the seed cultures could be available. For viruses, vaccine production-grade volumes would be needed, requiring special equipment and facilities, perhaps with state-sponsorship.
2. Availability may be commercially limited for the more toxic metals, especially the heavy metals, which can be quite expensive. Iron and copper are readily available, but not usually in soluble (bio-available) forms.
3. Availability of arsenicals and selenium compounds in the retail sector has been reduced owing to environmental regulations, but such products can occasionally be found as part of older inventories of merchandise, especially in small-town hardware stores. Supplies of such materials may generally be too small to cause concern.
4. This grouping includes riot-control agents and other mucous membrane irritants.
5. The quantity available from laboratories, suppliers, and pharmacies needed for widespread contamination of a water system are typically not available from these sources. Many biotoxins that occur naturally would need to be purified or prepared to be of significant concern to water, which could make production beyond the capabilities of most terrorists.

The specific contaminants in Table 1-1 do not directly correspond to the highest priority contaminants; the table is merely illustrative of the relevant contaminant classes. The list of high priority contaminants was used to inform the development of the material in the RPTB (particularly Module 4). The list of high priority contaminants is not included in the RPTB for two reasons. First, as discussed above, such lists are inherently incomplete and hence may provide a false sense of security. Second, such a list could be used with malicious intent if included in a widely circulated document. Accordingly, to support emergency management of water threats and incidents, a resource for contaminant specific information, the Water Contaminant Information Tool (WCIT), is being developed specifically for use by the water sector. The WCIT, along with related information resources, is described in more detail in Module 2, Appendix 8.9.

In reviewing the contaminant classes listed in Table 1-1, it may be apparent that many are not tightly controlled and are considered to be readily available. Most threat analysts consider availability to be the most important characteristic of a contaminant that might be used in a terrorist or criminal activity. The phrase *opportunity contaminant* has been used to describe contaminants that might be readily available even though they may be considered less than optimal from a lethality or dissemination standpoint. In many cases, specific opportunity contaminants may be more readily available on a regional or local basis. For example, a particular industrial chemical or pesticide may be produced at a facility in close proximity to the water treatment plant and its associated distribution system. **Such site specific considerations should be incorporated into a utility’s planning and response activities**, particularly with regards to *threat management* (Module 2) and *analytical approach* (Module 4).

In addition to availability, there are other factors that should be considered to better understand the contamination threat to water. Therefore, a broad group of potential contaminants, similar to those contained in Table 1-1, were prioritized with respect to their ability to adversely impact public health. The criteria used to prioritize the contaminants are described in Table 1-2. This prioritization was not intended to be comprehensive for all potential threats to water, but rather to be inclusive of contaminant classes that warrant consideration during the evaluation of a contamination threat or the analysis of a water sample for an unknown contaminant.

**Table 1-2. Prioritization Criteria for Potential Water Contaminants**

Criterion	Description
Aesthetic impacts	Changes in appearance, odor, or taste of contaminated water that might alert a consumer to the potential danger.
Availability	The ease with which the material can be obtained, synthesized, or harvested from natural sources.
Chlorine resistance	The time that a contaminant remains toxic or infectious after introduction into water containing a chlorine residual under typical distribution system conditions.
Dispersion	The ease with which a contaminant can be effectively dispersed in water.
Handling difficulty	The technical challenges associated with handling the material and introducing it into water.
Outcome of exposure	The health effects within the population resulting from exposure to the contaminant.
Potency	The amount of contaminant that would be required to contaminate a reference volume of water at a lethal or infectious dose. The smaller the amount of material, the higher the rank.
Public fear factor	Perception of the public regarding the risks associated with the contaminant.
Stability	The time that a contaminant remains toxic or infectious after introduction into an aqueous environment.
Storability	The time that a contaminant remains toxic or infectious while in storage.

**2.2 Warnings Signs of a Contamination Threat**

A *threat warning* is an occurrence or discovery that indicates a potential contamination threat that triggers an evaluation of the threat. The use of information about a threat warning during the initial stage of the *threat evaluation* process is described in more detail in Module 2. It is important to note that these warnings must be evaluated in the context of typical utility activity and previous experience in order to avoid **false alarms**. Figure 1-1 summarizes several potential threat warnings.



**Figure 1-1. Summary of Threat Warnings**

The threat warnings shown in this figure are intended to be inclusive of those most likely to be encountered, but this listing is by no means comprehensive. Following is a brief description of each of these warnings. A thorough discussion of these warnings is provided in Module 2.

- Security Breach. Physical security breaches, such as unsecured doors, open hatches, and unlocked/forced gates, are probably the most common threat warnings. In **most** cases, the security breach is likely related to lax operations or typical criminal activity such as trespassing, vandalism, and theft rather than intentional contamination of the water. However, it may be prudent to assess any security breach with respect to the possibility of contamination.
- Witness Account. Awareness of an incident may be triggered by a witness account of suspicious activity, such as trespassing, breaking and entering, and other types of tampering. Utilities should be aware that individuals observing suspicious behavior near drinking water facilities will likely call 911 and not the water utility. In this case, the incident warning technically might come from law enforcement, as described below. Note: the witness may be a utility employee engaged in their normal duties.
- Direct Notification by Perpetrator. A threat may be made directly to the water utility, either verbally or in writing. Historical incidents would indicate that verbal threats made over the phone are more likely than written threats. While the notification may be a hoax, threatening a drinking water system may be a crime under the Safe Drinking Water Act as amended by the *Bioterrorism Act*, and should be taken seriously.
- Notification by Law Enforcement. A utility may receive notification about a contamination threat directly from law enforcement, including local, county, state, or federal agencies. As discussed previously, such a threat could be a result of suspicious activity reported to law enforcement, either by a perpetrator, a witness, or the news media. Other information, gathered through intelligence or informants, could also lead law enforcement to conclude that there may be a threat to the water supply. While law enforcement will have the lead in the criminal investigation, the utility has primary

responsibility for the safety of the water supply and public health. Thus, the utility's role will likely be to help law enforcement to appreciate the public health implications of a particular threat as well as the technical feasibility of carrying out a particular threat.

- Notification by News Media. A threat to contaminate the water supply might be delivered to the news media, or the media may discover a threat. A conscientious reporter would immediately report such a threat to the police, and either the reporter or the police would immediately contact the water utility. This level of professionalism would provide an opportunity for the utility to work with the media and law enforcement to assess the credibility of the threat before any broader notification is made.
- Unusual Water Quality Parameters. The relationship between contamination and changes in water quality parameters is not well understood. However, it is appropriate to investigate the cause of unusual changes in water quality parameters. For water systems, changes in water quality parameters, such as pH, chlorine residual, turbidity, etc. may be detected through the use of either on-line monitors or grab samples. In utility operations, this data may arise from several sources: samples collected for plant operations, routine baseline monitoring programs (Section 4.9), and monitoring systems designed to provide early warning of changes in water quality (Section 6.2). The results of these approaches may be used to warn of a threat. However, as discussed in Sections 4.9 and 4.10, it is vital to consider the reliability of the results from the particular detection method or on-line monitoring system (i.e., false positives/false negatives, known interferences, instrument reliability, and unusual water quality conditions associated with a known cause, such as overdosing of coagulant).
- Consumer Complaint. An unexplained or unusually high incidence of consumer complaints about the aesthetic qualities of drinking water may indicate potential contamination. Many chemicals can impart a strong odor or taste to water, and some may discolor the water. Taste and odor complaints are quite common for water utilities, but unique taste and odor problems, particularly very unusual tastes and odor complaints clustered in a geographical area, may indicate additional problems.
- Public Health Notification. In this case, the first indication that contamination has occurred is the appearance of victims in local emergency rooms and health clinics. Utilities may therefore be notified, particularly if the cause is unknown or linked to water. An incident triggered by a public health notification is unique in that at least a segment of the population has been exposed to a harmful substance. If this agent is a chemical (including biotoxins), then the time between exposure and onset of symptoms may be on the order of hours, and thus there is the potential that the contaminant is still present. On the other hand, the incubation period for most pathogens is on the order of days to weeks; thus, the pathogen may have moved through the distribution system and may therefore be below detectable limits, or present only in trace quantities.

### 3 How should I Respond to Water Contamination Threats?

This section is not designed to discuss what specific steps to take in responding to a contamination threat. Various “What to do?” steps in the response process will be discussed in Section 4 and associated modules. Rather, the questions addressed in this section are “Why is it necessary to respond to contamination threats at all?” and “When have I done enough?”

#### 3.1 *I’m Just a Utility—Why Do I Need to do Anything at All?*

As discussed in Section 2, it is technically possible to introduce a contaminant into a public water supply, and historical evidence suggests that the threat of contamination is indeed probable. Regardless of whether contamination is actual or threatened, both deeply impact the public health mission of water utilities. Water utilities play an essential role in providing safe and reliable drinking water supplies, preventing many problems and diseases that flourish in the absence of safe water programs. Most water utilities take their public health mission very seriously, and some are proactive in developing their plans to respond to water contamination threats. They do this often because they realize that planning for contamination events may also be beneficial in developing a more effective response to other types of emergencies.

Proper planning is a delicate process because public health measures are rarely noticed or appreciated except when they fail. Consumers are particularly upset by unsafe water because safe drinking water is often viewed as an entitlement, and indeed, it is reasonable for consumers to expect a high quality product. Public health failures during response to contamination threats often take the form of too **much** or too **little** action. The results of too little action, including no response at all, can have disastrous consequences potentially resulting in public disease or fatalities. On the other hand, a disproportionate response to contamination threats that have not been corroborated (i.e., determined to be ‘credible’) can also have serious repercussions when otherwise safe water is unavailable. Not only would the water be unavailable for human consumption, but it would also be unavailable for sanitation, firefighting, industry, and the many other uses of public water supply. These adverse impacts must be considered when evaluating response options to a contamination threat.

Considering the potential risks of an inappropriate response to a contamination threat, it is clear that a systematic approach is needed to evaluate contamination threats. This systematic approach is developed throughout the RPTB. One overriding question is “When has a drinking water utility done enough?” This question may be particularly difficult to address when considering the wide range of agencies that may be involved in a threat situation. Other organizations, such as EPA, CDC, law enforcement agencies, health departments, etc., will each have unique obligations or interests in responding to a contamination threat.

#### 3.2 *Due Diligence—When Have I Done Enough?*

The guiding principle for responding to contamination threats is one of ‘due diligence’ or “what is a suitable and sensible response to a contamination threat?” As discussed above, some response to contamination threats is warranted due to the public health implications of an actual contamination incident. However, a utility could spend a lot of time and money over-responding



to every contamination threat, which would be an ineffective use of resources. Furthermore, over-response to a contamination threat carries its own adverse impacts.

Ultimately, the answer to the question of ‘due diligence’ must be decided at the local level and will depend on a number of considerations. Among other factors, local authorities must decide what level of risk is reasonable in the context of a perceived threat. Careful planning is essential to developing an appropriate response to contamination threats, and in fact, one primary objective of the RPTB is to aid users in the development of their own site-specific plans that are consistent with the needs and responsibilities of the user. Beyond planning, the RPTB considers a careful evaluation of any contamination threat, and an appropriate response based on the evaluation, to be the most important element of due diligence.

Figure 1-2 provides an overview of the response process presented in the RPTB that illustrates (through the two expanding vertical arrows) that response actions escalate as the credibility of a threat increases. In the RPTB, the threat management process is considered in three successive stages: ‘possible’, ‘credible’, and ‘confirmed’. Thus, as the threat escalates through these three stages, the actions that might be considered due diligence expand accordingly. The following paragraphs describe, in general terms, actions that might be considered as due diligence at these various stages. Module 2 describes the evaluation of these stages, and associated response actions that might be considered at each stage.

- Stage 1: “Is the threat possible?” If a utility is faced with a contamination threat, they should evaluate the available information to determine whether or not the threat is ‘possible’ (i.e., could something have actually happened). If the threat is ‘possible,’ *immediate operational response* actions might be implemented, and activities such as *site characterization* would be initiated to collect additional information to support the next stage of the threat evaluation.
- Stage 2: “Is the threat credible?” Once a threat is considered ‘possible,’ additional information will be necessary to determine if the threat is ‘credible.’ The threshold at the credible stage is higher than that at the possible stage, and in general there must be information to corroborate the threat in order for it to be considered ‘credible.’ Given the higher threshold at this stage, more significant response actions might be considered, such as restrictions on public use of the water (e.g., issuance of a ‘do not drink’ notice). Furthermore, steps should be initiated to confirm the incident and positively identify the contaminant.
- Stage 3: “Has the incident been confirmed?” Confirmation implies that definitive evidence and information have been collected to establish the presence of a harmful contaminant in the drinking water. Obviously, at this stage the concept of due diligence takes on a whole new meaning since authorities are now faced with a potential public health crisis. Response actions at this point include all steps necessary to protect public health, to supply the public with an alternate source of drinking water, and to begin remediation of the system.

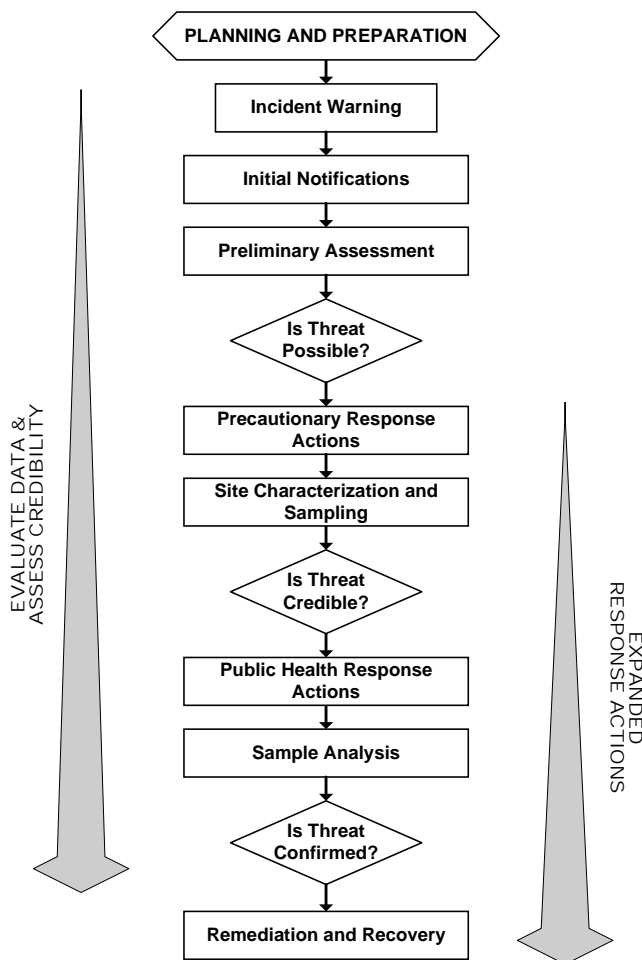

**Figure 1-2. Overview of Response to a Contamination Threat**

If the process outlined in Figure 1-2 is followed as far as the situation warrants, and the responsible parties use it as a guide in making appropriate response decisions, then they may be viewed as exercising ‘due diligence.’ All the modules of the RPTB contain in-depth information about the application of the process. In particular, Module 2 describes threat management and the three stages of the threat evaluation in great detail. **The application of this process to a specific contamination threat will vary significantly with the circumstances of the threat.** In summary, judgment must be exercised when determining how to appropriately manage a specific contamination threat. Tabletop exercises, described below in Section 4.7, may provide valuable practice in this regard.

## 4 What Can I do to Prepare?

One of the steps that utilities can take to prepare for contamination threats is to **read relevant modules of the “Response Protocol Toolbox” and use the information contained within to develop their own specific Response Guidelines and updated Emergency Response Plans!** Specific planning and preparation activities are summarized in the following subsections.

### 4.1 Know your Water System

#### 4.1.1 Construction and Operation

Each water system is unique with respect to age, operation, and complexity. Distribution systems are particularly unique in that many are a complex, and often undocumented, mix of relatively new and old components. Accordingly, understanding a distribution system as it relates to water security and response planning may be an equally complex task. Despite the challenges to understanding a water supply system, the benefits of doing so could include effectively managing threats and preventing the spread of potentially contaminated water. For instance, the water system may have structural features that enable effective isolation of a contaminated area. Also, it may be readily apparent from knowledge of system vulnerabilities that it would be very easy to introduce a contaminant at a particular location.

There are many ways to gain a better understanding of a particular water system, one of which is through a *vulnerability assessment*. Perpetrators who intentionally contaminate water may seek to produce an adverse consequence through exploitation of vulnerabilities. All drinking water plants are, to some degree, vulnerable to intentional contamination incidents. The nature and extent of these vulnerabilities depends on a number of factors such as source water type, treatment plant type, type of primary disinfectant used, residual disinfectant used in the distribution system, and security measures already in place. An assessment of the drinking water plant and system may help to identify key locations that are vulnerable to intentional contamination, or the availability of opportunity contaminants that might be prevalent in the area. Better understanding the vulnerabilities of a water system provide a basis for improving physical security against intentional contamination and preparing for the evaluation of contamination threats. Accordingly, the Bioterrorism Act established requirements that community water systems serving more than 3,300 individuals perform a system specific vulnerability assessment for potential terrorist threats, including intentional contamination (<http://www.epa.gov/safewater/security/community.html>).

Another aspect of the water system that may be important, particularly in evaluating the potential spread of a suspected contaminant, is its hydraulic configuration and operation. Propagation of a contaminant through a system is dependent on a number of factors, including: mixing conditions at the point of contamination, hydraulic conditions within the system at the time of the contaminant introduction, and reactions between the contaminant and other materials in the system. There are several techniques for understanding the hydraulics of a water supply system. As discussed more completely in Module 2, Section 2.3.1, developing this understanding may be as complex as utilizing a GIS system in conjunction with a hydraulic modeling program or as simple as manually mapping the pressure and flow zones within a system.

Information about construction materials used in the system may be contained within the utility records and can be useful in evaluating the fate and transport of a particular contaminant through a system. For example, a particular contaminant may adsorb to the pipe material used in a utility's distribution system, and this type of information would be critical in evaluating remediation options following a contamination incident (see Module 6).

### 4.1.2 Personnel

The employees of a water utility are generally its most valuable asset in preparing for and responding to water contamination threats and incidents. They have knowledge of the system and water quality, and may also have experience in dealing with previous contamination threats. The importance of knowledgeable and experienced personnel is highlighted by the complexity of most water treatment and distribution systems. This complexity makes a successful contamination of a specific target contingent upon detailed knowledge of the system configuration, hydraulic conditions, usage patterns, and water quality. If perpetrators have somehow gained a sophisticated understanding of a water supply system, the day-to-day experience of water system personnel will prove an invaluable tool to countering any attacks. For instance, personnel may continually look for unusual aspects of daily operation that might be interpreted as a potential threat warning, and may also be aware of specific characteristics of the system that make it vulnerable to contamination.

### 4.1.3 Customers

Knowledge of water system customers is an important component of preventing and managing contamination incidents. Prevention is based largely on understanding potential targets of contamination. Of special concern may be hospitals, schools, government buildings, or other institutions where large numbers of people could be directly or indirectly affected by a contamination threat or incident. Steps taken to protect the drinking water supply for these critical customers, such as enhancements to the physical security of distribution system elements at these locations, may deter the attack itself.

Water customers vary significantly with regard to their expectations of what constitutes acceptable water service, so it is necessary to consider the manner in which water is used in a particular system. For example, high water demand that is largely driven by industry has different implications compared to high usage rates in an urban center with a high population density. Some customers, such as hospitals and nursing homes, may have certain water quality requirements. Sensitive sub-populations, including children and the elderly, can exhibit adverse health effects at doses more than an order of magnitude lower than those necessary to produce disease or death in a healthy adult. That being said, for the purposes of managing water contamination threats, it is important to keep in mind that the most important goal is protecting the health of the public as a whole. Planning, preparation, and allocation of resources should be directed toward protecting the public at large, beyond specific demographic groups or individual users.

#### **4.2 Update Emergency Response Plans for Intentional Contamination**

Emergency response plans (ERPs) are nothing new to water utilities, since many have developed ERPs to deal with natural disasters, accidents, civil unrest, etc. Because water utilities are a vital part of the community, it has been prudent for many utilities to develop these in order to help ensure the continuous flow of water to the community. However, many water utility ERPs developed prior to 9/11 do not explicitly deal with terrorist threats, such as intentional contamination. Recently, the U.S. Congress required community water systems serving a population greater than 3,300 to prepare or revise, as necessary, an ERP to reflect the findings of their vulnerability assessment and to address terrorist threats (<http://www.epa.gov/safewater/security/community.html>).

In response to the legal mandate to revise ERPs, there is an increased demand for guidance that addresses terrorist threats to water supply systems. The U.S. EPA is preparing this guidance, which will be published in a separate document (U.S. EPA, 2003b, "Drinking Water Model Emergency Response Plan," in development. See also U.S. EPA, 2003c, "Large Water System Emergency Response Plan Outline: Guidance to Assist Community Water Systems in Complying with the Public Health Security and Bioterrorism Preparedness and Response Act of 2002). For those existing plans that can be revised, information contained in this RPTB may help utilities to address the contamination threat in their revised ERPs, although it should be noted that there is no regulatory requirement to use the RPTB in this manner. However, the RPTB does provide a framework that will aid utilities in planning an effective response to contamination threats, which might be considered during revision to their ERP.

#### **4.3 Develop Response Guidelines for Intentional Contamination**

Although not a formal part of an ERP, utilities may wish to develop *Response Guidelines* (RGs) for managing contamination threats. RGs are different from ERPs in that they are essentially a "field guide" for responding to contamination threats. RGs may be developed in many different formats, but a core feature of any RG is that it is easy to use in the field and under crisis conditions. Because RGs are used in the field, they should be action-oriented, easy to follow, and contain all the necessary forms and information. For instance, they should contain forms to document observations at the site of a suspected contamination incident and to log samples collected from the site. Additionally, the guidelines might include flow charts depicting the steps of a process, simple reference tables, and other information that can easily be used during the intense period of an initial response to a threat. A trained individual should be able to follow a well organized RG with minimal difficulty. While the RPTB is not set up in the streamlined format of an effective set of RGs, the material contained in the RPTB can certainly support the development of guidelines, and an example outline for a set of RGs is included in Appendix 5.1 of this Module. The outline may be filled using model text, figures, and forms contained in the various modules of the RPTB, in addition to the users' own materials.

#### **4.4 Establish Structure for Incident Command**

One of the primary reasons that ERPs and RGs fail (for any type of emergency, not just water contamination) is that there is no clear leader established by the plan. Thus, in planning for a water emergency, it is important to establish a command structure. This involves establishing a

chain of command, identifying key individuals, and clearly defining their roles and responsibilities, so that they may effectively manage the emergency situation. This section describes an incident command structure based on the *Incident Command System (ICS)*. See <http://training.fema.gov/EMIWeb/IS/is195.asp> for ICS training material produced by FEMA.

In summary, ICS is the model tool for command, control, and coordination of a response to a public crisis. The tool provides a means to coordinate the efforts of individual agencies as they work toward the common goal of stabilizing the incident and protecting life, property, and the environment. The rationale is that large-scale disasters may be multi-jurisdictional and require cooperation among several agencies. Furthermore, ICS is used by many local, state and federal response agencies and is part of the National Interagency Incident Management System (NIIMS). Note that NIIMS is different than the National Incident Management System (NIMS), which is under development for use by the National Response Plan (see Appendix 6.2 of this Module).

Federal law requires hazardous materials (HazMat) responders to use ICS, and many States are adopting ICS as their standard for responding to all types of incidents. However, in the ‘possible’ stage of the evaluation of a water contamination threat, HazMat will probably not be involved, and the mandated ICS may not be applied. Rather, the utility, or possibly a technical assistance provider such as a state drinking water primacy agency, would manage the threat. However, at some point following the determination that a contamination threat is ‘credible,’ the existing ICS at the local or State level would likely be implemented. For major disasters and emergencies, including terrorist acts, the Federal Response Plan (see Appendix 6.3 of this Module) provides the mechanism for federal departments and agencies to coordinate delivery of Federal assistance and resources to augment efforts of overwhelmed local and State governments. Fortunately, one of the benefits of ICS is its ability to expand and contract based on the needs of the situation. Thus, to make potential expansion as seamless as possible, it seems logical that utilities adopt ICS conventions during their response to a contamination threat, even during the ‘possible’ stage, to facilitate coordination between the utility and other responding agencies that may become involved at a later stage.

Figure 1-3 (left) provides a schematic of ICS for a water utility during a ‘possible’ threat, in which utility staff have primary responsibility for managing the threat (see Module 2, Section 3). It is anticipated that during this initial stage, the water utility staff will conduct the threat evaluation (Figure 1-3, top middle). At some point during the response to a ‘credible’ threat, various responding agencies would be organized under ICS according to the principle of *unified command*, and the IC might be someone from an outside organization such as FBI or the State/local health department (Figure 1-3, bottom middle). Unified command is a team effort which allows all agencies with responsibility for the incident, either geographic or functional, to manage an incident by establishing a common set of incident objectives and strategies. This is accomplished without abdicating agency authority, responsibility, or accountability. When command is transferred, it is anticipated that water utility staff will continue to occupy roles in the command structure, but this is at the discretion of the new incident commander. Figure 1-2 (right) is an example of unified command under ICS that might be assembled to respond to a ‘confirmed’ water contamination incident. For ‘confirmed’ incidents, it is assumed that an agency external to the water utility has assumed responsibility for incident command. However,

the utility will still have a role in this incident command structure since they are responsible for the operation and maintenance of the drinking water system.

Figure 1-3 is primarily intended to illustrate the expanding nature of the incident, show model ICS structures, and point out the changing role of the water utility in the command structure. It must be customized for a particular situation, and should be expanded and contracted as necessary. Regardless of the size and shape, the command structure operates most efficiently if each person in an organization reports only to one designated individual, a concept known as *unity of command*. Likewise, communication outside of the command structure should be made only through designated individuals (i.e., information officers, liaison officers, or points of contact). Following are some definitions used in Figure 1-3.

1. *Incident commander (IC)*: The IC sets incident objectives and priorities, and has overall responsibility for management of the incident. Thus, for water contamination, the incident commander coordinates all the activities involved, whether they are related to the water utility, local civil defense, public health, public works, etc. One key role of incident command is to effectively communicate with all participants involved in the management of the incident, including those outside of the water utility's own command structure. Various individuals may assume the role of incident commander depending on the stage of the response. In ICS, the initial incident commander is traditionally defined as the senior first-responder to arrive at the scene. However, due to the nature of water contamination events triggered by the warnings described above, it is likely that there will need to be a designated individual at the water utility who becomes the incident commander when a threat is reported. This individual is known as the water utility emergency response manager (WUERM).
2. *Water Utility Emergency Response Manager (WUERM)*: The WUERM is an individual (or several individuals) with designated responsibility for managing the utility's response to a contamination threat or incident. As discussed above, the WUERM will likely serve as IC during the early stages of the response. Given this responsibility, the WUERM should be empowered to make decisions regarding the threat evaluation (i.e., determining whether or not a threat is 'possible') and response decisions in the early stages of the threat management process. Should the threat rise to an appropriate level, the WUERM may recommend that the *emergency operations center* (EOC) be activated. Once the threat or incident rises to a level such that responsibility for incident command is transferred to another organization, the WUERM will still have a significant role in the response, and will likely serve as the utility's representative in the ICS structure.
3. *Water Utility Emergency Operations Center Manager (WUOCM)*: The WUOCM is an 'emergency manager' who heads the water utility's EOC, which is responsible for operational and resource management during an emergency. The general position of 'emergency manager' is described in FEMA's training documents, <http://training.fema.gov/EMIWeb/IS/is1.asp>, although specific duties for water utilities may differ. In most cases, responsibilities of the WUOCM and the WUERM will fall upon different individuals.

'Credible' stage investigation by utility

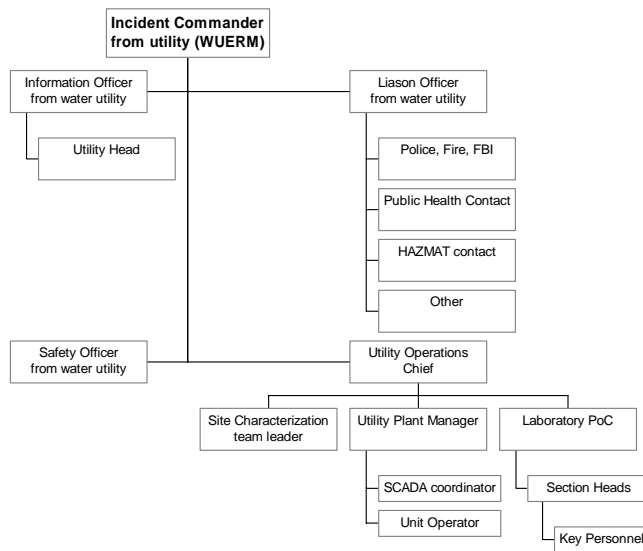

"Possible" threat

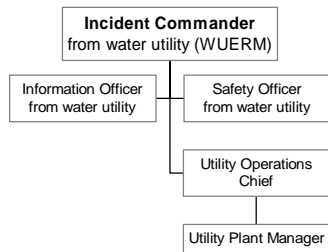

'Confirmed' threat investigated by unified command

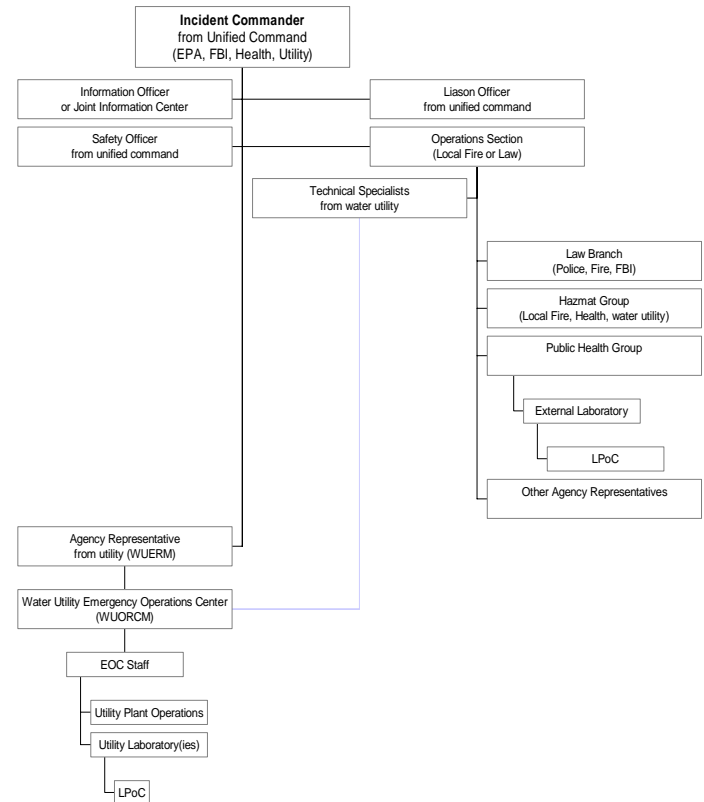

'Credible' threat investigated by unified command

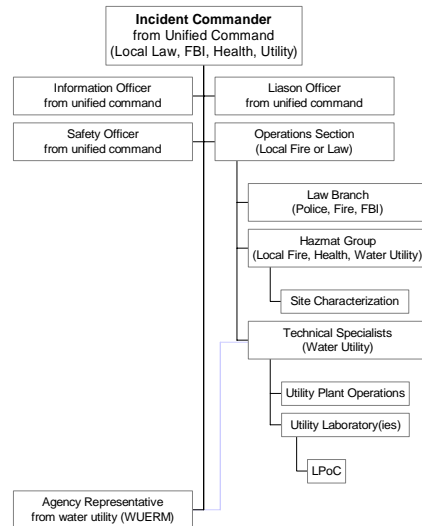

Figure 1-3. Expansion of, and Changes to, Incident Command Structure for the Three Threat Evaluation Stages



4. *Information Officer (IO)*: The IO is part of the command staff and reports directly to the IC. The IO is responsible for planning the information strategy, discussed in Section 4.5 below. Another very important role of the IO is interfacing with the media and disseminating public information.
5. *Liaison Officer (LO)*: The LO is part of the command staff and is the on-scene contact for representatives from other agencies assisting with the incident.
6. *Laboratory Point of Contact (LPoC)*: The LPoC is the designated person at the laboratory with whom the WUERM (or IC) communicates. The LPoC coordinates analytical activities with the WUERM (or IC) and reports analytical results only to the WUERM (or IC).
7. *Safety Officer*: The Safety Officer's function is to develop and recommend measures for assuring personnel safety, and to assess and/or anticipate hazardous and unsafe situations. Only one Safety Officer should be assigned per incident. The Safety Officer may have assistants as necessary, and the assistants may also represent assisting agencies or jurisdictions. Safety assistants may have specific responsibilities such as air operations, hazardous materials, etc.
8. *Agency Representatives*: In many *multi-jurisdiction incidents*, an agency or jurisdiction will send a representative to assist in coordination efforts. An Agency Representative is an individual assigned to an incident from an *assisting agency* or *cooperating agency* who has been delegated authority to make decisions on matters affecting that agency's participation at the incident. Agency Representatives report to the Liaison Officer, or to the Incident Commander in the absence of a Liaison Officer. As illustrated in Figure 1-3, if the WUERM is not the incident commander, then the WUERM may be the agency representative for the drinking water utility in the ICS.
9. *Technical Specialists*: Certain incidents or events may require the use of Technical Specialists who have a specialized knowledge and expertise. As illustrated in Figure 1-3, Technical Specialists may be assigned to any aspect of the response where their services are required. Because water utility staff have intimate knowledge of their own system, their role in this position will be invaluable during every stage of the response.

The identity of the WUERM, WUOCM, IO, LO, LPoC, and other designated individuals should be determined locally, based on the utility's size, needs, and responsibilities. Large systems may need to designate multiple WUERMs such that one is always available. Small utilities and small communities may have an abbreviated version of command structure. In this case, the WUERM, WOURC, IO, LO, and other designation individuals could be the same person, or some of these positions may be filled by individuals outside of the utility (e.g., from local government). For the case of the small utility, it may greatly enhance the response process if the particular individual understands ICS, because the small utility may need to coordinate with a larger, better resourced organization, like a state or federal entity. Also, in small systems, the WUERM will likely need to engage other decision officials at the state or local level earlier in the process than will the WUERM at large utilities.

#### **4.5 Develop Information Management Strategy**

As described previously, the role of the IO is to manage the large amount of information that might be used during the threat evaluation process and to support decisions about various response actions. For instance, Module 2 describes a number of information resources that may be of use during the threat evaluation process, but only if the information has been properly managed and is readily accessible. Thus, provisions should be made to readily access this information.

Crisis Information Management Software (CIMS) may be useful, especially when interfaced with a central data repository and/or electronic data management system. A description and comparison of several commercial CIMS packages has been prepared by the Department of Justice (DOJ, <http://www.ncjrs.org/pdffiles1/nij/197065.pdf>). A Field Operations and Records Management System (FORMS), originally developed for EPA's Contract Laboratory Program, may also help manage records relevant to sample documentation, analysis, and tracking during evaluation of water threats (<http://www.epa.gov/superfund/programs/clp/f2lite.htm>).

Another component of information management is planning for the flow of information during the response to a threat or incident. The individuals or agencies responsible for receipt and management of information are related to the communication strategy described in the next section. However, as part of the information management strategy, a plan must be developed for the flow of information to appropriate individuals within the ICS structure. The release of inaccurate information at an inappropriate time can have severe consequences for the response, criminal investigation, and well-being of the public.

The proper flow of communications during a crisis can be facilitated through the establishment of a Joint Information Center (JIC), a structure that works within the framework of ICS (See [http://www.nrt.org/production/nrt/home.nsf/Resources/publications/\\$FILE/JIC.pdf](http://www.nrt.org/production/nrt/home.nsf/Resources/publications/$FILE/JIC.pdf) for a JIC model). This model documents a plan for conducting crisis communications during response to emergencies in which multiple organizations need to collaborate to provide timely, useful, and accurate information to the public and other stakeholders. The model was designed based on requirements identified by the National Response Team (<http://www.nrt.org>). Although the model was not developed expressly for water utilities, some of the criteria used in the model's development are appropriate for a water utility's information management strategy. Because it is designed on the basis of function, the model can be used during any situation in which there is a need for centralized communications support involving multiple organizations.

It is important to highlight the IO's responsibility as a contact for the media and public. In this manner, the media and public receive information from a single source, which may help eliminate the confusion inherent to an emergency situation. It is important for the media and public to understand that the IO is the only official source of information about the emergency, and that they are receiving information from a consistent source. For this reason, it may be desirable that the IO remains the same even if the incident commander changes, as may be the case for incidents that reach the 'confirmed' stage (see Figure 1-3).

#### **4.6 Establish Communication and Notification Strategy**

The ICS requires communication strategies be planned and made available to all potential participants prior to an actual incident or threat. For the purposes of responding to a water contamination threat, the ICS structure illustrated in Figure 1-3 indicates there could be several management levels within the utility, as well as external to the utility, that may be involved in the management of a contamination threat. The hierarchy of potential participants includes: the utility, local government, the regional government (e.g., county), state government, and federal government. Not all of these levels would necessarily be involved in every situation; however, the mechanism and process through which they interact must be decided in advance of an incident to achieve optimal public health and environmental protection. Due to the number and variety of possible participants, **planning for effective communication is critical**. ICS employs two main strategies to ensure effective communication. The first is the use of common terminology, and the second is unity of command.

Regardless of the strategy employed within the ICS, developing the plan requires a significant level of effort. An effective communication plan is more than just the telephone directory of utility employees and external contacts, although such a directory is often beneficial. Rather, planning communications involves developing a notification hierarchy for reporting threat warnings and other critical information to appropriate individuals at each stage of the response. Many of the individuals that would need to be notified at key points in the response are identified in the ICS, but others may be outside the ICS chain of command. For example, the head of the utility or the drinking water primacy agency may wish to be notified in the case of any threat, although neither may be in the ICS chain of command. However, in general, communications should proceed along the chain of command of the ICS. The number of people notified will increase as the incident expands and decrease as it contracts toward its conclusion. The exact persons notified will be at the discretion of the IC with interaction with the IO, and should be planned in advance. Local requirements may influence the required communication at the various stages.

Figure 1-4 is designed to illustrate the expanding nature of notifications as the threat evaluation proceeds through the ‘possible,’ ‘credible,’ and ‘confirmed’ stages. Figure 1-4 is primarily intended to show the utility’s role in the communications, which is based on the ICS structure shown in Figure 1-4. Accordingly, the communications depicted in Figure 1-4 are only those parts of Figure 1-3 in which the utility is involved. The three stages in Figure 1-4 illustrate a possible structure of the communication hierarchy upon expansion but does not necessarily define the exact path or circumstances under which expansion will occur as a threat escalates. Careful planning and thoughtful actions during the management of the threat will dictate how this expansion will occur. Figure 1-4 shows an example notification hierarchy for each stage of the threat management process, and in the situation in which the credibility determination is made by the utility and the credibility determination is made by an external organization. Utilities should plan communication schemes for both of these cases because, although the role of individuals within the ICS may change, the individual involved will not.

# MODULE 1: Water Utility Planning Guide

'Possible' stage evaluation by utility

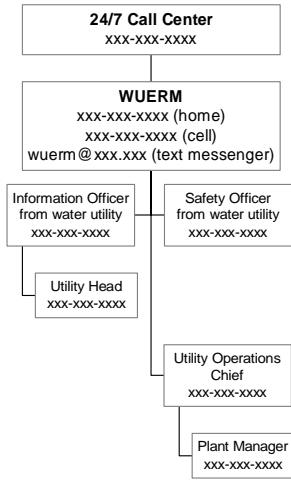

'Credible' stage evaluation by utility

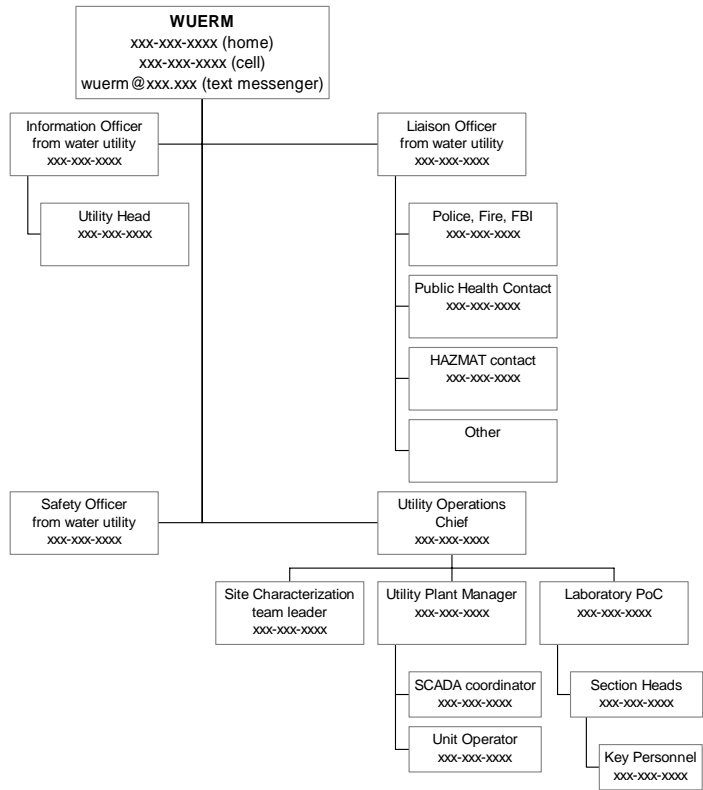

'Credible' stage evaluation by unified command

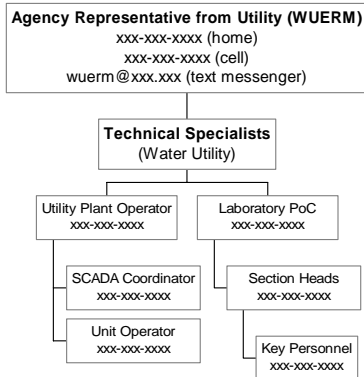

'Confirmed' stage evaluation by unified command

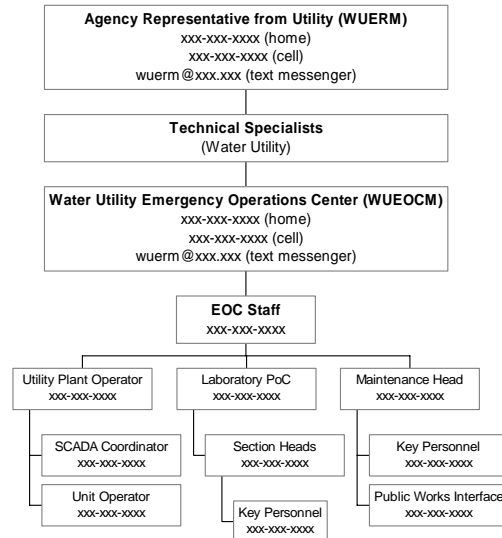
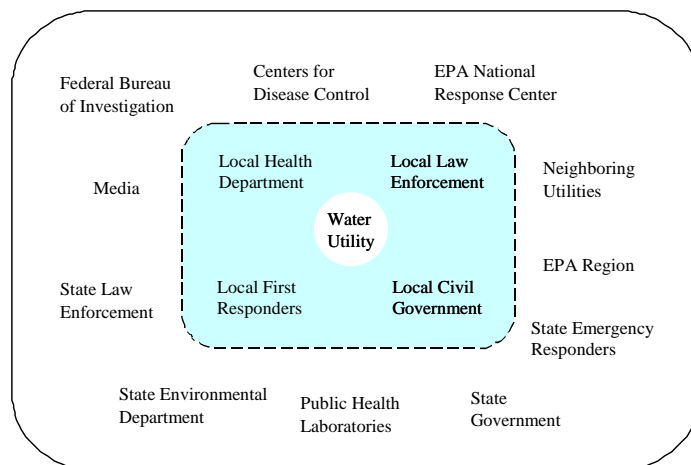

Figure 1-4. Sample Communication Schemes for the Three Threat Evaluation Stages

For the ‘possible’ stage (Figure 1-4, top left), most of the communications and notifications are internal and begin with the WUERM being notified about the threat. However, depending on the nature of the threat warning, it may be necessary to notify external agencies at the ‘possible’ stage (e.g., notification of law enforcement in the case of a direct threat from a perpetrator). Utilities must establish some mechanism for informing the WUERM of the incident. A 24/7 operations center may be effective for this purpose. The scale and staffing of an operations center will vary substantially with utility. For example, a large utility may have a continually staffed center. A smaller utility may provide the WUERM(s) with a cell phone or perhaps leverage other call centers that exist within the local government.

The WUERM is notified first, and then the WUERM may notify the heads of other departments to get their support for the threat evaluation. The WUERM would also continue notification along the management chain to keep them apprised of the situation. As the threat management process expands, it may be necessary to activate the IO to manage communications with the utility’s management chain, as well as external parties. This will allow the WUERM to focus on the overall management of the response to the contamination threat.

It is likely that the utility will carry out the initial phases of the threat evaluation at the ‘credible’ stage. Figure 1-4 (top right) shows a sample communication scheme, based on internal utility staff and also external parties that may be able to provide information and technical assistance relevant to the threat evaluation. Figure 1-5 expands on some of the “other” external parties that the IO or LO in Figure 1-4 (top right) may need to contact. Note that the local entities in this figure may be contacted earlier than those at higher levels of government.



**Figure 1-5. Overview of Potential External Notifications**

Figure 1-5 does not seek to define a notification scheme or their possible role within the ICS structure – both of these tasks will be incident-specific and/or dictated at the local level. Rather, the figure provides a basic structure for the parties typically involved. These parties are divided into those that are external but still local, and those that are external but at higher levels of government. Notifications by the utility during the threat evaluation at the ‘credible’ stage

include the drinking water primacy agency (often the State), the emergency response community (including HazMat, EMS, etc.), law enforcement agencies (local, state, and/or federal), government agencies (local, state, and/or federal), the public health community, and external laboratories. Not all of these notifications need to be made in every incident—the overall response plan may dictate what level of notifications should occur and at what stage of the threat evaluation, which in turn dictates who will make the notification. For instance, depending on State requirements, it may not be appropriate for the utility to contact the EPA National Response Center directly. Nevertheless, contact information should be available for all individuals and organizations that may need to be contacted.

If additional support agencies (e.g., HazMat or law enforcement) respond during the ‘credible’ stage of the threat evaluation, then incident command may be transferred to one of these agencies (Figure 1-4, bottom left). However, staff from the utility’s command structure, such as the WUERM, IO and the LO, may still be extremely helpful advisors to the new incident commander; thus, the utility’s contact list should be available to unified command. Unified command will handle most communications at this point, so Figure 1-4 (bottom left) only depicts those parts of the ICS structure in which the utility will be involved. The communication strategy represented in Figure 1-4 (bottom left) conforms to Figure 1-3. In this case, more specialized individuals at the water utility become involved as technical specialists, and the WUERM is now acting as the Agency Representative from the water utility. The technical specialists will be a very important part of the ICS, and the utility should plan communication with these individuals carefully.

The ‘confirmed’ stage pictured in Figure 1-4 (bottom right), represents a significant change in the communication structure because an external agency operating under unified command will be in charge of the response. Also, the Water Utility Emergency Operations Center (WUEOC) will likely be activated (if it was not already during the ‘credible’ stage). The chain of communications may proceed through the WUEOC manager (WUEOCM). Technical Specialists that participate in the ICS operated under unified command may also be part of the EOC staff. Additional technical specialists may need to be notified, such as those responsible for repair and maintenance, who would not necessarily be engaged before the incident is confirmed. The role of the utility in overall management and command of the incident may proportionally decrease as many other external parties become involved (see Figure 1-5).

#### **4.7 Perform Training and Desk/Field Exercises**

In addition to a lack of planning, another reason that emergency response plans fail is lack of training and practice. Training provides the necessary means for everyone involved to acquire the skills to fulfill their role during an emergency. It may also provide important ‘buy-in’ to the response process from both management and staff, which is essential to the success of any response plan. Desk exercises (also known as ‘tabletops’ or ‘sand lots’) along with field exercises allow participants to practice their skills. Also, these exercises will provide a test of the plan itself, revealing strengths and weakness that may be used to improve the overall plan. Improvements can include measures not only for intentional contamination of water, but also for other emergencies faced by the water utility and the community at large.

Training may be available from EPA or other federal partners. For instance, several online training courses relevant to emergency management are available on-line from FEMA (<http://training.fema.gov/EMIWeb/IS/crslist.asp>). These courses cover a range of topics including community disaster exercises, emergency manager orientation, and animal health and safety during disasters. Further, it is worthwhile mentioning some areas where formal training is desirable, but not currently available. For example, in addition to training for sampling and site characterization, there are also training needs for a general understanding of the overall threat management process and the ability to make important decisions quickly and with limited information. In the absence of formal training, the reports, forms, templates, SOPs, and checklists that make up a set of RGs may be used as worksheets to practice potential scenarios.

#### **4.8 Enhance Physical Security**

Denying physical access to key sites within the water system may act as a deterrent to a perpetrator. Criminals often seek the easiest route of attack, just like a burglar prefers a house with an open window. Aside from deterring actual attacks, enhancing physical security has other benefits. For example, installation of fences and locks may reduce the rate of false alarms. Without surveillance equipment or locks, it may not be possible to determine whether a suspicious individual has actually entered a vulnerable area. The presence of a lock and a determination as to whether it has been cut or broken provides sound, although not definitive, evidence that an intrusion has occurred. Likewise, security cameras can be used to review security breaches and determine if the incident was simply due to trespassing or is a potential contamination threat. The costs of enhancing physical security may be justified by comparison to the cost of responding to just one ‘credible’ contamination threat involving site characterization and laboratory analysis for potential contaminants.

The correct choice of security enhancements varies by utility, and a number of resources are available to assist in this selection process. For instance, a vulnerability assessment (see Section 4.1.1) may provide a sound basis for making security upgrades. The American Water Works Association has developed a field guide (AWWA, 2002) to help meet security challenges. EPA has developed a series of Security Product Guides to assist treatment plant operators and utility managers in reducing risks from, and providing protection against, possible natural disasters and intentional terrorist attacks (<http://www.epa.gov/safewater/security/guide/index.html>).

#### **4.9 Establish Baseline Monitoring Program**

Background concentrations of suspected or tentatively identified contaminants may be extremely important in determining if a contamination incident has occurred. In some cases, and for some contaminants, background levels may be at detectable concentrations. **If unrecognized, these may be confused with an actual contamination incident.** Baseline occurrence information, discussed more thoroughly in Module 3, Section 3.5, is derived from monitoring data and is used to characterize typical levels of a particular contaminant or water quality parameter. Baseline data may be used for two purposes in the context of emergency water sampling:

- If general water quality parameters, such as pH, chlorine residual, or conductivity, among others, are used as indicators of possible contamination incidents, a baseline must be established such that significant deviations from the baseline can be observed.

- If a specific contaminant is detected in the water, knowledge of typical background levels may be necessary to properly interpret the results.

#### **4.10 Utilize and Understand On-line Monitoring**

On-line monitors are a topic of much interest, although there is a significant level of debate regarding their effectiveness as an early warning system (EWS). AWWARF has published a report discussing on-line monitoring for drinking water utilities (AWWARF, 2002), which outlines the cost-benefit analysis for online monitoring. Many of the costs and benefits are based on issues of general water quality, plant operations, and regulatory compliance. One definite benefit is early detection of changes in water quality parameters, such as pH, chlorine residual, and turbidity. Changes in these parameters relate to treatment plant operation, and may also indicate potential water contamination if properly interpreted. For instance, on-line monitoring may help establish typical background levels of the monitored parameters. These established background levels can then be compared with levels recorded during a suspected contamination incident. Another benefit of on-line monitoring for water security is that it can free operators from manual data collection, and facilitate analysis and interpretation of the data for routine as well as security purposes. Such information should be integrated into the information management plan (see Section 4.5).

In summary, the use of on-line monitors may serve to increase the quality of water in general, but there are unanswered questions regarding their applicability as EWSs. Currently, there are efforts underway within EPA and the water industry to attempt to resolve these issues and also to verify that commercially available on-line monitors perform as effectively as their manufacturers claim. Results of this work may be reported in later versions of the RPTB. The results of EPA efforts to verify monitoring technologies can be found at <http://www.epa.gov/etv>. Because of interest in on-line monitoring systems that are currently available, a discussion of the two main types, conventional systems and EWSs, is included in Appendix 6.2.



## 5 References and Resources

References and information cited or used to develop this module are listed below. The URLs of several sources are cited throughout the text. These URLs were correct at the time of the preparation of this document. If the document is no longer available at the URL provided, please search the sponsoring organization's Web site or the World Wide Web for alternate sources. A copy of referenced documents may also be provided on the CD version of this module, although readers should consult the referenced URL for the latest version.

AWWA. 2002. *Water System Security: A Field Guide*, American Water Works Association, Denver, CO.

AWWARF. 2002. *Online monitoring for drinking water utilities*. Editor, Erika Hargesheimer, AWWA Research Foundation and CRS PROAQUA, American Water Works Association, Denver, CO.

AWWARF. 2003. *Actual and Threatened Security Events*, AWWARF Project 2810, American Water Works Association, Denver, CO.

<http://www.awwarf.org/research/TopicsAndProjects/projectSnapshot.aspx?pn=2810>

DHS. 2003a. "Initial National Response Plan"

[http://www.dhs.gov/interweb/assetlibrary/Initial\\_NRP\\_100903.pdf](http://www.dhs.gov/interweb/assetlibrary/Initial_NRP_100903.pdf)

FEMA. 2003a. "IS-195 Basic Incident Command System – EMI Independent Study Program"

<http://training.fema.gov/EMIWeb/IS/is195.asp>

FEMA. 2003b. "Independent Study Course List"

<http://training.fema.gov/EMIWeb/IS/crslst.asp>

FEMA. 2003c. "Federal Response Plan"

<http://www.fema.gov/rrr/frp/>

DOJ/NIJ. 2002. "Crisis Information Management Software (CIMS) Feature Comparison Report"

<http://www.ncjrs.org/pdffiles1/nij/197065.pdf>

WHO. 2001. "Health Aspects of Biological and Chemical Weapons"

[http://www.who.int/emc/pdfs/BIOWEAPONS\\_FULL\\_TEXT2.pdf](http://www.who.int/emc/pdfs/BIOWEAPONS_FULL_TEXT2.pdf)

U.S. EPA. 2002. "EPA Community Drinking Water Security Requirements"

<http://www.epa.gov/safewater/security/community.html>

U.S. EPA. 2003a. "The Safe Drinking Water Act"

<http://www.epa.gov/safewater/sdwa/sdwa.html>

U.S. EPA. 2003b. *Model Emergency Response Plan*, in preparation.

U.S. EPA. 2003c. “Large Water System Emergency Response Plan Outline: Guidance to Assist Community Water Systems in Complying with the Public Health Security and Bioterrorism Preparedness and Response Act of 2002”

<http://www.epa.gov/ogwdw/security/pdfs/erp-long-outline.pdf>

U.S. EPA. 2003d. “FORMS II Lite” <http://www.epa.gov/superfund/programs/clp/f2lite.htm>

U.S. EPA. 2003e. “Security Product Guides”

<http://www.epa.gov/safewater/security/guide/index.html>

U.S. EPA. 2003f. “Environmental Technology Verification (ETV) Program”

<http://www.epa.gov/etv>

International Life Sciences Institute Risk Science Institute. (ILSI). 1999. Early Warning Monitoring to Detect Hazardous Events in Water Supplies. ILSI PRESS, Washington, DC.

<http://www.ilsi.org/file/EWM.pdf>

NRT. 2000. “NRT Joint Information Center Model: Collaborative Communications During Emergency Response”

[http://www.nrt.org/production/nrt/home.nsf/Resources/publications/\\$FILE/JIC.pdf](http://www.nrt.org/production/nrt/home.nsf/Resources/publications/$FILE/JIC.pdf)

NRT. 2003. “National Response Team” (2003) <http://www.nrt.org>

WHO. 2003. “Public health response to biological and chemical weapons: WHO guidance, 2nd edition (Draft, May 2003)” <http://www.who.int/csr/delibepidemics/biochemguide/en/index.html>

## 6 Appendices

### 6.1 Sample Outline of Response Guideline

A Response Guideline is essentially a “field guide” for responding to contamination threats, and may be composed of appropriate figures, forms, templates, text, and checklists, which can be found in Modules 2 through 6. Expanding the outline below with the content from Modules 1-6 (as listed and/or linked within the outline) should result in an essentially complete response guideline. See the table of contents for the modules for exact locations.

#### EMERGENCY RESPONSE GUIDE OUTLINE

1. Overview of/Introduction to Response Guidelines (Module 1, Section 4.3)
2. Threat Warning Descriptions (Module 1, Section 2.2)
3. Initial Communication and Notifications (Module 1, Section 4.6)
4. Threat Evaluation
  - a. Threat Warning Report Forms (Module 2, Appendix 8.3-8.8)
  - b. Threat Evaluation Worksheets (Module 2, Appendix 8.2)
5. Site Characterization
  - a. Site Characterization Plan Template (Module 3, Appendix 8.1)
  - b. Field Testing Results Form (Module 3, Appendix 8.3)
  - c. Site Characterization Report Form (Module 3, Appendix 8.2)
  - d. Sample Documentation Form (Module 3, Appendix 8.4)
6. Planned Responses
  - a. Response Planning Matrix (Module 2, Appendix 8.1)
  - b. Action Plan (Module 2, Section 2.4)
  - c. Guidelines for Contaminant Containment (Module 5, Section 4)
  - d. Contaminant Identification (Module 4)
  - e. Treatment, Removal And/or Disposal of Contaminant (Module 6, Section 6)
  - f. Public Notification (Module 5, Section 5)
  - g. Alternate Domestic Water (Module 6, Section 5)
  - h. Fire Flow Supply (Module 6, Section 5)
  - i. Expanded Communications (Module 1, Section 4.6)
7. Plan for Return of Water System to Service (Module 6, Section 8)
8. Appendixes
  - a. Appendix I: Phone Directories for Notifications (Module 1, Section 4.6)
  - b. Appendix II: Drinking Water Advisories (Module 5, Appendices 8.2 – 8.5)

## 6.2 U.S. Government Response Plans

### 6.2.1 National Response Plan

The U.S. Department of Homeland Security was tasked by the Homeland Security Presidential Directive 5 (HSPD-5) to develop, submit to the Homeland Security Council, and administer a National Response Plan (NRP). HSPD-5 required the development and publication of an Initial NRP (INRP), which was released on September 30, 2003. Pending the development of the full NRP, the INRP provides an interim implementation of the domestic incident management authorities, roles, and responsibilities of the Secretary of Homeland Security as defined in HSPD-5. It also provides interim guidance on Federal coordinating structures and processes for domestic incident management. The INRP is applicable to domestic incident management in the context of terrorist attacks, major disasters, and other emergencies. A final NRP will eventually replace the INRP. In the interim period, until the full NRP becomes effective, current Federal incident management and emergency response plans remain in effect, except as specifically modified by the INRP. The full text of the INRP is available at [http://www.dhs.gov/interweb/assetlibrary/Initial\\_NRP\\_100903.pdf](http://www.dhs.gov/interweb/assetlibrary/Initial_NRP_100903.pdf) and a fact sheet is found at [http://www.dhs.gov/dhspublic/interapp/press\\_release/press\\_release\\_0278.xml](http://www.dhs.gov/dhspublic/interapp/press_release/press_release_0278.xml)

INRP represents a significant first step towards an overall goal of integrating the current family of Federal domestic prevention, preparedness, response, and recovery plans into a single all-discipline, all-hazards plan. The INRP will be supported by the National Incident Management System (NIMS), a national system under development that creates standardized incident management processes, protocols, and procedures.

There are five current emergency response plans that are linked by the INRP:

- Federal Response Plan
- U.S. Government Interagency Domestic Terrorism Concept of Operations Plan
- Federal Radiological Emergency Response Plan
- Mass Migration Response Plans
- National Oil and Hazardous Substances Pollution Contingency Plan

Of these, perhaps the Federal Response Plan is most relevant to water contamination, and it is more completely described below in Appendix 6.2.2.

### 6.2.2 Federal Response Plan

The Federal Response Plan (FRP, <http://www.fema.gov/rrr/frp/>) provides the mechanism for federal departments and agencies to coordinate delivery of Federal assistance to State and local governments during a major disaster or emergency, including terrorist acts. The FRP supports implementation of the Robert T. Stafford Disaster Relief and Emergency Assistance Act (Stafford Act), as amended (42 U.S. Code 5121, et seq.), as well as individual agency statutory authorities. Under the Stafford Act, a State Governor may request the President to declare a major disaster or an emergency if an event is beyond the combined response capabilities of the

State and affected local governments. Only after the President makes a declaration is the FRP used.

As directed by Presidential Decision Directive (PDD)-39, U.S. Policy on Counter-terrorism, and as articulated in the FRP (FEMA, 2003c), the Department of Justice (DOJ) is designated as the lead federal agency for threats or acts of terrorism within U.S. territory. DOJ assigns lead responsibility for “crisis management” to the Federal Bureau of Investigation (FBI), who acts predominantly in a law enforcement capacity. Crisis management refers to the process by which resources needed to apprehend and prosecute perpetrators are identified, acquired and utilized. Within that process, the FBI operates as the on-scene manager for the Federal Government. It is FBI policy that crisis management will involve only those Federal agencies requested by the FBI to provide expert guidance and/or assistance, as described in the PDD-39 Domestic Deployment Guidelines (classified) and the FBI Weapons of Mass Destruction (WMD) Incident Contingency Plan.

FEMA, a branch of the Department of Homeland Security (DHS), supports the lead federal agency for “consequence management” throughout the Federal response, or serves as the lead federal agency when the Attorney General transfers the role to DHS. Consequence management refers to measures to protect public health and safety, restore essential government services, and provide emergency relief to governments, businesses, and individuals affected by the consequences of terrorism. It is DHS policy to use FRP (FEMA, 2003c) structures to coordinate all Federal assistance to State and local governments for consequence management.

The FRP provides more detailed guidance on the post-incident management and responsibilities of various federal departments and agencies (see Terrorism Incident Annex, Section V, FEMA 2003c). In summary, no single agency or organization at the Federal, State, local, or private-sector level possesses the authority and expertise to unilaterally implement remediation and recovery actions. If Federal assistance is provided under the authorities of the Stafford Act, responsibility for specific tasks will be delegated by the lead agency to those entities that possess the skills and resources required for implementing them. Key areas of responsibility that would potentially support water system remediation and recovery efforts are highlighted below:

**DOJ/FBI.** DOJ delegates the role of lead federal agency (LFA) to the FBI for operational response. The FBI responsibilities potentially supportive of remediation and recovery will include:

- Designating and establishing a Joint Operations Center (JOC) in the field;
- Appointing an FBI On-Scene Commander (OSC) who will convene and chair meetings of operational decision makers representing lead State and local agencies, DHS/FEMA, and other supporting Federal agencies (e.g., EPA);
- Working with DHS to establish and operate a Joint Information Center (JIC) in the field as a focal point for information to the public and media concerning Federal response;
- Issuing and tracking the status of crisis management actions assigned by the FBI; and
- Designating appropriate liaison and advisory personnel to support DHS.

**DHS.** DHS supports the overall LFA by operating as the lead agency for consequence management until the overall LFA role is transferred to DHS. DHS will:

- Work with the FBI to establish and operate a JIC in the field as the focal point for information to the public and the media concerning the Federal response to the emergency;
- Establish the primary Federal operations centers for consequence management in the field and Washington, DC;
- Appoint a Regional Support Team (RST) Director or Federal Coordinating Officer (FCO) to manage and coordinate the Federal consequence management response in support of State and local governments. In coordination with the FBI, the RST Director or FCO will convene meetings with decision makers to formulate incident action plans, define priorities, review status, resolve conflicts. These meetings may also be used to identify issues that require decisions from higher authorities, and evaluate the need for additional resources. Decision makers present at meetings may include Federal, State, and local emergency management and technical support agencies, as appropriate;
- Issue and track the status of consequence management actions assigned by DHS;
- Designate appropriate liaison and advisory personnel to support the FBI; and
- As needed, provide assets of the National Disaster Medical System and/or the Metropolitan Medical Response System.

**HHS.** As directed in PDD-39, the Department of Health and Human Services (HHS) will activate technical operations capabilities to support the Federal response to threats or acts of WMD terrorism. HHS may coordinate with individual agencies identified in the HHS Health and Medical Services Support Plan for the Federal Response to Acts of Chemical/Biological (C/B) Terrorism. Coordination efforts will use the structure, relationships, and capabilities described in the HHS plan to support response operations. Note that CDC, and thus the Laboratory Response Network (LRN), is part of HHS. If the HHS plan is implemented:

- The HHS on-scene representative will coordinate the HHS plan response with the DHS;
- The HHS plan response may include consultation, agent identification, epidemiological investigation, hazard detection and reduction, decontamination, public health support, medical support, and pharmaceutical support operations; and
- HHS will issue taskings that draw on funding from the responding HHS plan agencies.

**EPA.** As directed in PDD-39, the EPA will activate technical operations capabilities to support the Federal response to acts of WMD terrorism. EPA may coordinate with individual agencies identified in the National Oil and Hazardous Substances Pollution Contingency Plan (NCP)<sup>1</sup> to use the structure, relationships, and capabilities of the National Response System as described in the NCP [40 CFR Part 300 subpart B] to support response operations. If the NCP is implemented:

- The Hazardous Materials On-Scene Coordinator under the NCP will coordinate the NCP response with the DHS official (either the RST Director or the FCO), who is responsible under PDD-39 for on-scene coordination of all Federal support to State and local governments; and

---

<sup>1</sup> Agencies listed in the NCP include: USCG, FEMA, DOD, DOE, USDA, DOC, HHS, DOI, DOJ, DOL, DOT, DOS, NRC, and GSA.

- The NCP response may include threat assessment, consultation, agent identification, hazard detection and reduction, environmental monitoring, decontamination, and long-term site restoration (environmental cleanup) operations.

**USACE.** Under FRP Emergency Support Function (ESF) #3, Public Works and Engineering Annex, the U.S. Army Corps of Engineers (USACE) serves as the primary agency responsible, in part, for emergency restoration of critical public facilities. Activities can include the temporary restoration of water supplies and emergency contracting to support public health and safety, such as providing for potable water.

**State and Local Authorities.** State and local authorities maintain initial responsibility for managing domestic incidents. The Federal Government will assist State and local authorities when their resources are overwhelmed or when Federal interests are involved. In those cases, the local or state agencies (e.g., local health department) should work in partnership with the LFA.

**Water Utility.** The water utility will possess the most detailed first-hand knowledge and technical expertise regarding the configuration and operation of the water source, storage, treatment, and distribution systems. Accordingly, water utility personnel will serve as technical advisors to lead agency personnel responsible for system characterization, remediation, and recovery. If Federal assistance is provided under the authorities of the Stafford Act, responsibility for specific tasks most likely will be delegated to the water utility by DHS/FEMA or EPA (who will support long-term site restoration and environmental cleanup). In addition, the water utility can play a key role in planning for a remedial response to contamination, including evaluating containment options, and ensuring rapid site access and access to operating records, engineering drawings, etc., that may be required by response action personnel.

### **6.3 On-Line Monitoring Systems**

#### **6.3.1 Conventional systems**

Conventional on-line monitoring systems are largely designed to measure typical water quality parameters in a near-real or real-time fashion. Examples of these parameters include: temperature, turbidity, particle counts, color, conductivity, total dissolved solids, alkalinity, pH, chlorine residual, specific UV absorbance, TOC, along with a host of inorganic and organic chemicals. In addition, water flow, level, and pressure may be automatically recorded. Many of these systems are designed to meet regulatory goals related to the reduction of turbidity, DBP formation, and other water quality parameters. These systems are often connected to a utility's SCADA and/or GIS system. The water quality parameters accessible through these systems may also have water security applications, specifically by providing a warning of a possible threat, as discussed in Section 2.2. However, interpretation of this data must be performed cautiously, as discussed in Module 2.

#### **6.3.2 Early warning systems**

The goal of an early warning system (EWS) is to identify a low probability/high impact contamination incident in a water system allowing sufficient time for an appropriate response that mitigates or eliminates any adverse impact resulting from the incident (ILSI, 1999). Typically, an EWS for water would be designed to detect the introduction of toxic or infectious contaminants that pose a risk to public health. According to the ILSI report, an ideal EWS would 1) be fully automated, 2) have a rapid response time and high sampling rate, 3) provide a specific and sensitive screen for a range of contaminants, 4) have a low occurrence of false positives and negative, 5) be reliable and rugged, 6) be easy to use, and 7) be affordable to install and operate. Although there are many on-line monitoring systems currently being discussed for use as EWSs, currently, an EWS with all of these features does not exist.

Among the technologies currently promoted as potential EWSs are toxicity monitors, which rely on a biological species as a sentinel for the presence of the contaminant. These range from large animals such as fish to various microbial species of algae. Another approach relies on conventional monitors, in which changes in conventional water quality parameters, such as temperature, chlorine residual, color, conductivity, and pH, are used discretely or in a multi-parameter analysis to infer the presence of a contaminant. Ideally, computerized data systems for these detectors may automatically report significant changes in these parameters. It is important to note, however, that the baseline of these parameters needs to be carefully understood, as well as the relationship between changes in the water quality parameters and the presence of specific contaminants.

Implementation of a poorly characterized monitoring technology will result in a false sense of security since there is no assurance that it is capable of meeting the monitoring objectives. In a worst-case scenario, implementation of a poorly characterized system could result in false alarms that undermine the effectiveness of a monitoring program and result in a needless expenditure of resources to follow up on the false positive result.



Before initiating an early warning monitoring program, the objectives of the program should be clearly defined, and a plan should be developed for the interpretation, use, and reporting of monitoring results. It is critical that this plan be developed before there is a need to monitor or respond to a threat warning and that the plan be developed in coordination with the water utility, local and state health departments, emergency response units, and local political leadership. The consequences of improper coordination among authorities or inappropriate responses to monitoring results can be severe. The key is to have these guidelines and procedures in place prior to deployment of the monitoring system.

As part of the monitoring plan, a hierarchy for dissemination of positive monitoring results should be developed, and this notification hierarchy should be consistent with the utility's overarching ERP. This hierarchy should be based on consideration of who needs the information to make public health decisions and at what time the information is needed. Initially, the results might need to be rapidly disseminated to the WUERM, utility management, emergency response personnel, and the State or local health department. These preliminary monitoring results might trigger various response actions, such as a threat evaluation, additional sampling and confirmatory analysis, and immediate operational response actions.

Another consideration is whether or not to communicate to the public information regarding monitoring efforts designed to counter terrorism. On one hand, public support may be necessary to secure funding for such a monitoring effort, and this may bolster public confidence in the water supply. Also, it could be argued that monitoring could serve as a deterrent to potential criminal or terrorist activities. However, the counter argument is that publicizing a monitoring system, or other security measures, may be viewed as a challenge to terrorists and may increase the likelihood of threats, hoaxes, or attacks. Furthermore, it may provide enough information to allow a criminal entity to determine which contaminants are being monitored and to simply use a contaminant that cannot be detected in an attack on a water supply. It has been suggested that efforts taken to counter terrorism and improve security be put into a context of general preparedness for a variety of incidents or emergencies (ILSIRI, 1999). This will allow a utility to communicate efforts that are being taken to ensure continued operation and the safety of the water supply without focusing on any one specific threat, such as intentional contamination through terrorist activity.

